

PART FOUR

Current Approaches to the Structural Conservation of Panel Paintings



Florentine Structural Stabilization Techniques

Andrea Rothe and Giovanni Marussich

MORE DAMAGE WAS CAUSED by the great flood of 1966 in Florence than by both World Wars combined. Many paintings and other artifacts were submerged in the floodwaters for more than eighteen hours. They were covered with mud mixed with heavy deposits of heating oil that had seeped from the storage tanks housed in the many basements of the city. The worst damage was done to the large number of panel paintings in Florence and the surrounding countryside; those that had been submerged swelled many inches beyond their original size.

Subsequently, these paintings were subjected to a long and gradual drying process, first in the *limonaia*, the old hothouses built by the Medici in the Boboli Gardens for their favorite collection of citrus plants. These hothouses were quickly converted into one large humidity chamber. The humidity was raised to 95% at a temperature of 12 °C over a two-year period. Afterward, the treatment was continued in the former army barracks of the Fortezza da Basso, which in the meantime had been transformed into the largest restoration laboratory in the world; it had, in fact, become an independent governmental department, a *soprintendenza*, by special decree.

Despite the carefully controlled drying process, many of the panels shrank considerably. This shrinkage caused severe blistering and cupping of the paint layers, as well as deformation of the supports (Cianfanelli, Ciani Passeri, and Rossi Scarzanella 1992). Consequently, many of the panel paintings had to be transferred to canvases and to new, rigid supports. The oil deposits were removed with a poultice made from Shellsol A and talc applied to a Japanese-tissue interleaf.

The devastation caused by the flood was, to some degree, offset by the benefit of the better understanding that was gained about the behavior of wooden artifacts—panel paintings in particular. For instance, the negative effects of dovetails, which had already gone out of style by the end of the 1950s, were confirmed (see Rothe, “Critical History,” herein). The negative effects of rigid restraints or crossbars in relation to the natural flexibility of panels were better understood. It became clear that those restraints that held the panels in place but did not hinder their need to expand and contract were the most effective.

It also became obvious that the materials that were used for crossbars had to be stable and unaffected by environmental fluctuations. *Mansonite*, which had been widely used in Florence by the restoration

departments of the Vecchie Poste at the Uffizi and Palazzo Pitti before the flood, proved to be the most stable wood, with the least tendency to deform (see Rothe, “Critical History,” herein).¹ Used for more than forty years in the construction of crossbars, mansonia functions very efficiently and, in fact, appears to be better than any other type of wood because of its density and workability. Panels with mansonia crossbars expanded and contracted drastically after the flood but did so with little or no buckling. Planks of mansonia that had been immersed for over a week and then inadvertently used as gangways to wheel mud out from the ground floor of the Vecchie Poste did not deform or crack, and they were later utilized to make new crossbars. Today mansonia is still used—although much less often because of its toxic properties. Other woods, such as steamed beech, have also been used but have not given such satisfying results. Metal crossbars, such as those used successfully in Rome by the Istituto Centrale del Restauro, have rarely been used in Florence, primarily because of aesthetic considerations (see Rothe, “Critical History,” herein).

If a panel is in good condition, the conservator usually chooses not to intervene. Unfortunately, this is not always possible. Intervention is necessary whenever the original crossbars have been lost (causing warpage), the panel has previously been thinned, splits have caused loss of color, or panels have cracked apart. The restraint that a brace or crossbar should exert on a panel is difficult to measure or predict, but today the rule is to give the panel ample lateral freedom to move and to manipulate the original surface as little as possible by making the braces much smaller than was formerly considered appropriate, and thus more flexible (Figs. 1, 2).

Excessive restraint such as that caused by older cradles tends to block the movement and facilitate the formation of new cracks and even of splits (Figs. 3, 4). Conversely, too little restraint can allow panels to deform, especially those that have been thinned and have lost their original coating (see Rothe, “Critical History,” herein) or the aged “skin” that

Figure 1
Guglielmo di Pietro de Marcillat,
Annunciation, 1524. Reverse. Oil or mixed
technique (?) on panel, 180 × 150 cm.
Convent of S. Francesco, Sargiano, Arezzo. A
typically heavy crossbar of the early 1970s,
with pegs glued and screwed to the panel; a
wide swath of original wood surface was
removed to create a level area. The crossbar
on the bottom is original.

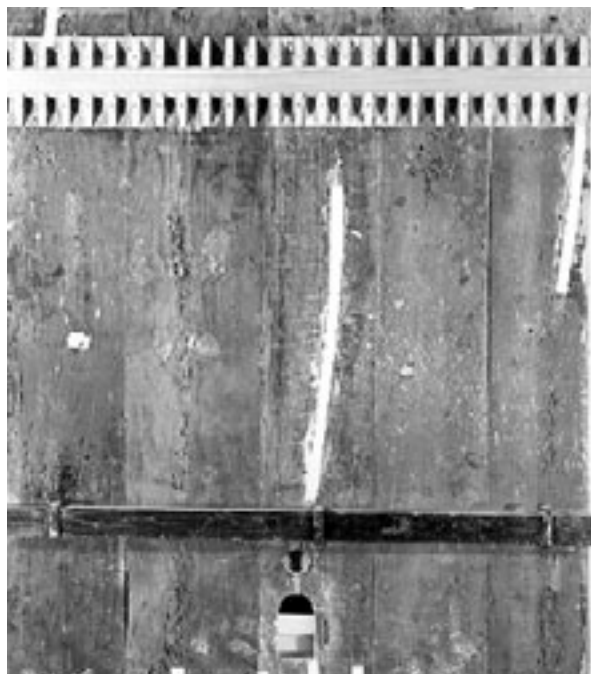
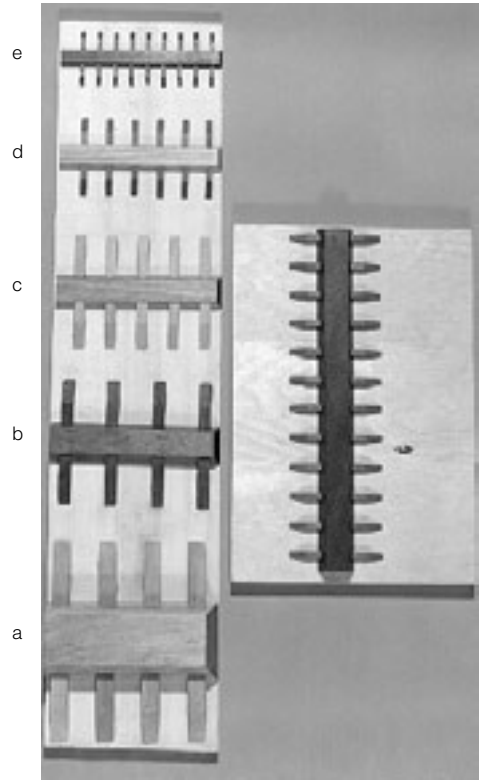

Figure 2

Examples of crossbars showing progressive reduction in size. (a) Crossbar used in 1975 on the *Annunciation* by Guglielmo di Pietro de Marcillat, Convent of S. Francesco, Sargiano, Arezzo; the panel is 150 cm wide, the crossbar 7.5 cm wide. (b) Crossbars used in 1988 on the *Nativity* by Girolamo di Benvenuto, The J. Paul Getty Museum, Los Angeles; the panel is 161 cm wide, the crossbars 4.5 cm wide. (c) Crossbars used in 1989 on *The Birth of Bacchus* by Giulio Romano, The J. Paul Getty Museum; the panel is 80 cm wide, the crossbars 3.2 cm wide. (d) Crossbars used in 1987 on *The Card Players* by Joos van Crasbeeck, The J. Paul Getty Museum; the panel is 31.1 cm wide, the crossbars 2.7 cm wide. (e) If crossbars were to be placed on *The Card Players* today, a smaller version (1.8 cm wide) would be used. (f) Crossbars used in 1990 on *The Abduction of Proserpine* by Alessandro Allori, The J. Paul Getty Museum; the panel is 228 cm wide, the crossbars 3.3 cm wide.

*Figure 3, below*

Girolamo di Benvenuto, *Nativity*, ca. 1500. Reverse. Tempera on panel, 204 × 161 cm. The J. Paul Getty Museum, Los Angeles. A heavy cradle is glued to the panel, which had been thinned to less than 12 mm. This intervention dates to about 1900.

forms on the back of old panels (consisting primarily of compacted wood cells and accumulated dirt).

In the Florentine approach to rejoining panels, the precision with which the work is carried out is key to the success of the treatment. This approach is described as *risanamento delle tavole*, “making panels sound again.” The pivotal task is to cut precise V-shaped grooves of approxi-

*Figure 4, above*

Girolamo di Benvenuto, *Nativity*. Detail. This raking-light photograph shows distortions and cracks on the surface caused by the thinning of the panel and the restraint of the heavy cradle.

Figure 5
Some tools used in the preparation of
V-shaped grooves.

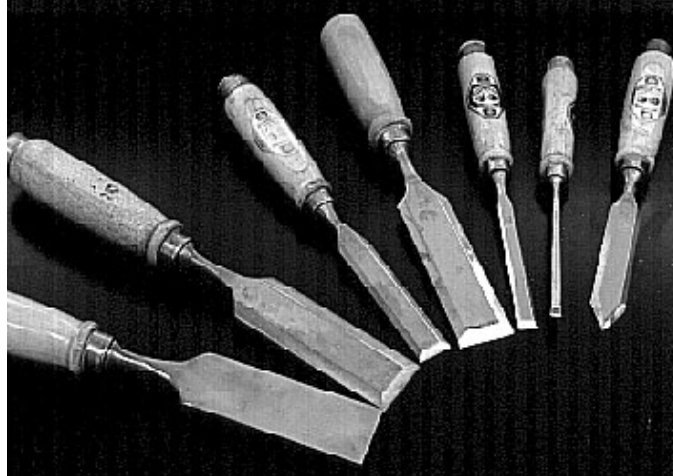

mately 55° . The groove should straddle the crack all the way down to the gesso preparation; short, individually fitted wedges are then inserted into these grooves. The grooves should be made as deep as possible without causing damage to the paint layer, so as to avoid the formation of hairline fissures (see Rothe, "Critical History," herein).

The type of wood used to reconstruct these panels should be well-aged material of the same type as the original painting support. The various chisels used, including a pointed chisel for the finishing of the V-shaped grooves, must be maintained in constant sharpness (Fig. 5). If percussion is needed, the ball of the hand (never a mallet) may be used. In some instances, when the cracks are straight and long, two angled planes are used—one for the left side of the split, the other for the right side (Fig. 6).

Before the wedges are inserted, the detached sections of the panel must be perfectly flush with each other. This is accomplished by a simple system of temporary braces, or *tiranti*, that are screwed into the panel

Figure 6
Two angled planes, sometimes used for
preparing long, straight grooves.

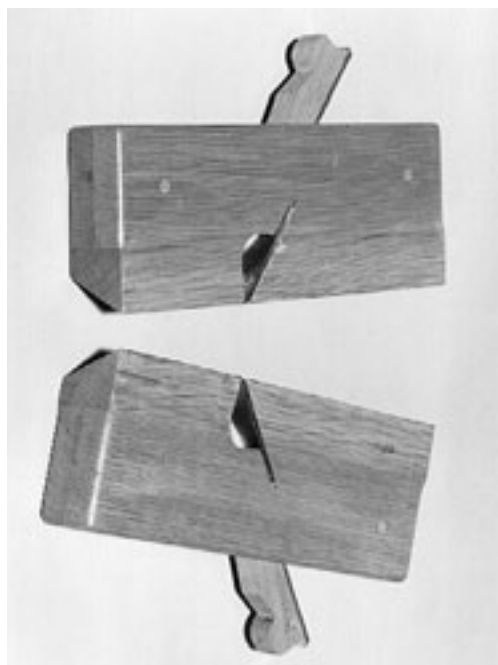



Figure 7
Temporary tiranti, or levers, used to pull distorted surfaces of separated panel boards back into plane before wedges are glued into previously prepared grooves.

wherever necessary along the crack. By strategic placement of the screws and the small blocks under the braces, either side of the split can be pushed down or pulled up (Fig. 7). If the panel is very thin, little blocks of wood can be temporarily glued onto the panel to hold the screws in the areas that need to be leveled. The glue used for softer woods, such as poplar and limewood, is mostly a polyvinyl acetate (PVA) emulsion glue such as Vinavil, thinned with water.² Woodworkers point out that the glue that oozes out is what ensures a lasting bond—meaning that the less glue that remains between the wedge and the wood of the panel, the better. For harder woods such as oak, a two-component epoxy glue such as Araldite is used.³

For those who are not master artisans, a simpler and quite effective method was developed by Barbara Heller at the Detroit Institute of Arts after she worked for many years in Florence (Heller 1983). She cuts the grooves with a router and uses precut V wedges that are set in with Araldite carvable paste.⁴ The results have been very encouraging and seem to be stable, especially in the case of softer woods such as poplar.

The movable crossbars are held in place by pegs, or *nottole*, that are glued to the panel with an epoxy adhesive. The section of the crossbars is trapezoidal, and particular care is used in planing the sole and the two side edges. To ensure a perfect glide, hot paraffin is applied to the edges and polished, and the same is done to the face of the pegs.

The crossbars and pegs of the early 1950s were much heavier and wider. The pegs were not only glued to the panel but also screwed on, thus locally blocking the movement of the panel. Two or three wide swaths were also planed flat across the panel to accommodate the width of the crossbars with the pegs (Fig. 1). This method removed much of the aged skin, something that is no longer done today. To overcome the irregularities of the panel, individual spacers are now fitted and glued between the pegs and the panel.

The Opificio delle Pietre Dure restoration department at the Fortezza da Basso has carried out more panel restoration than any other institution in the world; consequently, it has gained a wealth of unique experience. It has introduced and perfected many new systems that reduce interference with the tendency of wood to move. Where deemed appropriate, the angle of the V-shaped cuts has been reduced at times from 55° to just 7.5° with a special router bit (Castelli, Parri, and Santacesaria 1992). Although this approach interferes less with the original wood, the woodworker does not have as much control with a router as with a handheld chisel and therefore cannot cut as close to the original gesso layer; this deficiency might, in time, result in a weaker joint (Castelli, Parri, and Santacesaria 1992).

Other systems may be used to minimize the interference with the original panel, such as the method of attaching the crossbars without pegs. Instead, a system of sparsely distributed brass threaded inserts is screwed and glued into the panel. The crossbars are slotted lengthwise at the same intervals as those of the threaded inserts, and identically slotted brass plates are set into the crossbars. These crossbars are then attached with long bolts that fit into the center of the slotted brass plates and are directly screwed into the threaded inserts glued into the panel. The bolts are not tightened excessively, and a Teflon washer can be used to facilitate lateral movement. A simplified version of this method consists of fastening the crossbars, which are also slotted, with long, round-headed brass



Figure 8
Various screws and bolts used in less invasive types of crossbar attachments.

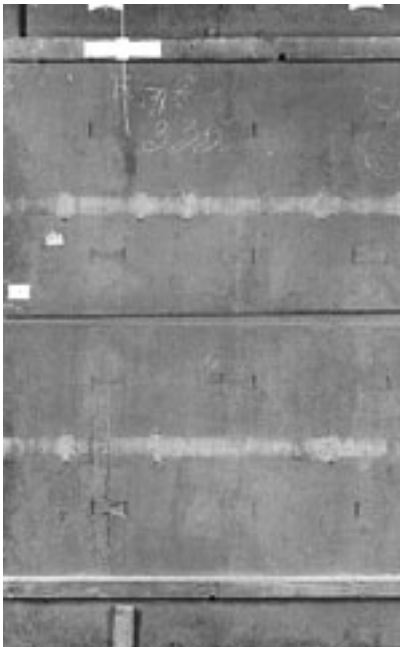

Figure 9
Lorenzo Sabbatini, *Madonna and Child Enthroned with Two Saints*, ca. 1560. Reverse. Oil on panel, 151.8 × 229.0 cm. Staatliche Museen zu Berlin, Preussischer Kulturbesitz, Gemäldegalerie. The loss of the central crossbar has caused severe convex warpage. The dovetail insets are probably original.

screws that are inserted directly into the original wood of the panel. Unfortunately, if the crossbars need to be removed and reattached several times, the screw holes will eventually wear out if this simpler method is used. In either case, to prevent rusting, only brass screws and steel bolts are used (Fig. 8).

At times panels need to respond in more than one direction to humidity fluctuations. Expansion and contraction are sometimes augmented by a tendency of the panel to warp—a tendency that, if impeded, might cause the panel to split. For this reason methods have been devised to add some form of spring action to the construction of crossbars. The simplest method consists of adapting existing older cradles with springs that are fitted into carved recesses at the junction of the braces and battens. For this purpose the battens are also thinned to facilitate movement (Castelli, Parri, and Santacesaria 1992).

Another method improves the system of bolts discussed above in the construction of new battens or the adaptation of original ones. It consists of steel springs of approximately 2.5 × 7.5 cm that are lodged into slotted and carved recesses in the crossbars so as to give the bolts ample space to move and to allow the panel not only to expand and contract but also to flex up and down (Castelli, Parri, and Santacesaria 1992). A more sophisticated method makes use of conical springs that are inserted into the crossbar. The brass nuts are held in place by pegs made out of lime-wood glued to the back of the panel (Castelli, Parri, and Santacesaria 1992).

A system for thin panels that provides the most freedom of movement consists of a strainer that is constructed around the panel. The strainer holds the panel in place with springs attached to small wooden blocks that are glued to the panel. This system is not ideal for environments that have no climate control, as it does not offer enough restraint to the panel: in some cases panels treated in this manner have deformed and cracked. A much simpler and more effective solution in this case is the mounting of the painting into its frame with steel springs, as has been done at the Bavarian State Galleries in Munich (by Christian Wolters).⁵ The newest methods, which are mentioned by Castelli (see “Restoration of Panel Painting Supports,” herein) deal with more sophisticated spring mechanisms that permit panels to flex.

The guiding idea behind all these constructions should be to give the panels ample room to move while at the same time exerting a certain amount of restraint to keep them from deforming. The authors have observed old panels—such as a painting by Lorenzo Sabbatini, *Madonna and Child Enthroned with Two Saints* from the Staatliche Museen zu Berlin (Bode Museum)—that have deformed because they have lost all or part of their original restraints (Fig. 9). The general guideline is not to treat a panel if it has survived in good condition, but if original crossbars are missing and the panel has a tendency to deform, the crossbars need to be replaced. Wooden panels need to be held in plane gently but firmly; otherwise they may deform, especially if exposed to uncontrolled climatic environments, as is the case with the great majority of panel paintings in the world.

Moisture barriers can be of some help in the centuries-old drying process of a panel by slowing down its constant response to changes in humidity (Buck 1978). The most commonly used materials have been Lucite 2044 or 2045 and Acryloid B72.⁶ Saran and wax have also been used.⁷ Fortunately, the unaesthetic and sometimes heavy constructions of wax and balsa wood that have been used often in the United States and England

Figure 10

Gherardo Starnina, *Madonna and Child with Musical Angels*, ca. 1410. Tempera and gold on panel, 92 x 51.3 cm. The J. Paul Getty Museum, Los Angeles. The pronounced cracking of the paint film was caused by excessive drying of the back following an intervention of more than sixty years ago. At that time, the poplar panel was reduced from its original thickness of more than 25 mm to less than 5 mm.



have rarely been adopted in Florence. New problems for future interventions are created when materials such as wax cannot be removed completely; their residues can prevent the effective use of PVA or epoxy glues.

Some previous attempts to straighten poplar panels were made by thinning them down to less than 7 mm and attaching heavy cradles to the backs, as in the case of the *Madonna and Child with Musical Angels* by Gherardo Starnina in the J. Paul Getty Museum in Los Angeles, California (Fig. 10). The effects—such as severe cupping or flaking of the paint film—of these radical interventions can often be seen on the front of the painting (Fig. 11). In cases in which the original support has been severely altered, it may actually be beneficial to attach the panel instead to a rigid support, such as a laminated strip board, rather than to let it move freely, as previously described (Fig. 12). For example, a painting attributed to Giovanni Bellini, *The Presentation in the Temple* (private collection, Venice), which has a severe flaking problem, had been thinned to less than 5 mm and cradled. It was decided to attach the panel painting to a laminated strip board after it was evenly planed to a thickness of about 4 mm. The glue used was Vinavil, a PVA emulsion, although today (as was used on the Starnina) an epoxy adhesive such as Araldite is preferred in order to avoid the excessive absorption of water from the PVA emulsion. Since treatment in 1966 the Bellini has been exposed at various times to a completely uncontrolled environment (Tintori and Rothe 1978). As with the

Figure 11

Gherardo Starnina, *Madonna and Child with Musical Angels*. Detail. This raking-light photograph of the upper left portion shows pronounced cracking of the paint film.



Figure 12

Gherardo Starnina, *Madonna and Child with Musical Angels*, reverse. After the back of the painting was planed even, it was attached to a laminated strip board with an epoxy adhesive (see note 4). This method also creates a humidity barrier.



Starnina panel, the treatment of which was carried out in 1982, the condition is stable, and no new signs of cupping or flaking have been observed.⁸

The conservator must always keep in mind where objects are to be housed. In a climatically stable environment, even a heavy cradle will have very little negative effect on a painting; consequently, it might be wiser to leave well enough alone. Many paintings, however, must be returned to environments that are not climate controlled. These paintings need adequate freedom of movement, some form of moisture barrier (without complex constructions), and protection from structural experiments. New methods and ideas are constantly being developed, and though it is in the nature of conservators to continually change, one sometimes cannot help but wonder if it is not better to stay with some of the structural conservation methods that have proved their effectiveness over time, rather than constantly expose panel paintings to experimental innovations.

Notes

- 1 *Mansonia altissima*; the tree comes from the rain forests of Ghana, Ivory Coast, and Nigeria. The sapwood has characteristics similar to those of the heartwood; the heartwood, which is slightly toxic, is most often used.
- 2 Vinavil NPC, Stella Bianca, is a nonionic dispersion of medium plasticized acetate emulsion in water (see Materials and Suppliers).
- 3 General-purpose epoxy structural adhesive AW 106 and hardener HV 953 (see Materials and Suppliers).
- 4 Epoxy structural adhesive (carvable paste, wood) AV 1253 and HV 1253 (see Materials and Suppliers).
- 5 Wolters has also supplied information—verbally and by demonstration—about this type of mounting (Munich, 1956).
- 6 Lucite 2044 and 2045 are the Italian product names; in the United States they are also called Elvacite. The adhesive 2044 is an n-butyl methacrylate, and 2045 is an isobutyl methacrylate. Both are of high molecular weight. Acryloid B72, also known as Paraloid B72 in Europe, is an ethyl methacrylate copolymer. (See Materials and Suppliers.)
- 7 Saran F.120 is a vinylidene chloride-acrylonitrile copolymer. It was first introduced by Richard Buck in 1961. After the flood, Sheldon Keck came to Florence and proposed a 30% solution in methyl ethyl ketone as a moisture barrier. Saran F.220 was also used. (See Materials and Suppliers.)
- 8 Both treatments were executed by Giovanni Marussich and Renzo Turchi.

Materials and Suppliers

Acryloid B72, Rohm and Haas Co., Independence Mall Street, Philadelphia, PA 19105.

Araldite AV 1253/HV 1253 and AW 106/HV 953, Ciba-Geigy Corporation, 4917 Dawn Avenue, East Lansing, MI 48823.

Elvacite, Du Pont Company, Polymer Products Dept., Methacrylate Products Group, Wilmington, DE 19898.

Saran F.120 and F.220, Dow Corning Corporation, Midland, MI 48640.

Shellsol A, Shell Oil Company, P.O. Box 4320, Houston, TX 77210.

Vinavil NPC, Stella Bianca, Enichem Synthesis, Italy.

- Buck, R. D.**
1978 The use of moisture barriers on panel paintings. In *The Behavior of Wood and the Treatment of Panel Paintings*, 26–36. Minneapolis: Upper Midwest Conservation Association, Minneapolis Institute of Arts.
- Castelli, C., M. Parri, and A. Santacesaria**
1992 Supporti lignei: Problemi di conservazione. In *Problemi di restauro, riflessioni e ricerche*, ed. Umberto Baldini, 41–63. Florence: Edizione Firenze.
- Cianfanelli, T., F. Ciani Passeri, and C. Rossi Scarzanella**
1992 Il consolidamento dei dipinti su tavola. In *Problemi di restauro, riflessioni e ricerche*, ed. Umberto Baldini, 89–108. Florence: Edizione Firenze.
- Heller, B.**
1983 The joining of wood panels with Araldite epoxy system. Abstract of a paper presented at the Paintings Specialty Group, 11th Annual Meeting of the American Institute for Conservation, 29 May, Baltimore.
- Tintori, L., and A. Rothe**
1978 Observations on the straightening and cradling of warped panel paintings. In *Conservation of Wood in Painting and the Decorative Arts*, ed. N. S. Brommelle, Anne Moncrieff, and Perry Smith, 179–80. London: International Institute for Conservation of Historic and Artistic Works.

The Restoration of Panel Painting Supports

Some Case Histories

Ciro Castelli

THIS ARTICLE PRESENTS work by the Division of Restoration for Canvas and Panel Paintings at the Opificio delle Pietre Dure e Laboratori di Restauro (OPD) in Florence.

General Criteria for Conservation Intervention

The paintings described below were selected because of their varied construction techniques and the conservation problems they pose, problems that were not remedied by past restoration attempts. Presentation of these works provides an opportunity to explain various options for the repair, consolidation, and construction of support and control systems for panel paintings. Effective examples of restoration have in common critical methodologies that offer the least possible invasion of the artwork. All the original components of the work are respected. It is understood that every intervention to the wooden support entailing alterations, intrusions, or substitution of support parts or of the control structures may give rise to dangerous, difficult-to-control tensions and deformations in the wooden construction.

Interventions were tailored for each painting with the aim of designing a coordinated restoration plan that addressed each panel's particular problems. To prepare for such a plan adequately, the data-gathering phase in conservation is fundamental.

Understanding a work of art begins with the study of its original construction technique, the state of preservation of all its constituent materials, and any past restorations. Subsequently, the conservator should select appropriate diagnostic tests that deepen this understanding and assist in identifying past conservation attempts. Finally, the conservator can outline a plan for the various restoration phases.

For the design of the plan, it is imperative to know the relative humidity (RH) of the environment from which the painting came, as well as how it will be exhibited in the future, so that the necessary steps can be taken for climate control. If this information is not available, as is often the case, or if there is too much uncertainty, the conservator will need to apply a protection directly to the work, or in proximity to it, that is compatible with the principles already cited. It is hoped that these introductory remarks and the presentations that follow make it clear that the author does not believe in the existence of a miraculous substance or in a restoration intervention that is capable of solving every kind of conservation problem for panel paintings. Rather, it is possible to obtain good results by

applying a series of interventions, whether they be in the form of treatments or of preventive conservation efforts.

The primary goal in restoring panel paintings is to renew the functionality of the structural support and to improve stability (with resulting benefits for the preparatory and paint layers) while adopting methods with minimal invasiveness. The following examples of works restored during the past few years in Florence will better clarify these concepts.

The Coronation of the Virgin by Domenico Beccafumi

The first example is *The Coronation of the Virgin*, an altarpiece painted by Domenico Beccafumi in 1540 (Fig. 1). The painting, which comes from the Church of the Santo Spirito in Siena, was executed for the Camaldolite monastery of Ognissanti, outside of Porta Romana in Siena. After the monastery's abolishment, the panel painting was moved to the Accademia in Florence and exhibited until 1810. In 1832 Romanelli recorded it in the sacristy of the Church of the Santo Spirito following its replacement with the *Annunciation* by Girolamo del Pacchia. The work was finally placed over the third altar on the right side of the church.

Figure 1

Domenico Beccafumi, *The Coronation of the Virgin*, 1540. Oil on panel, 310 × 187 cm. Church of the Santo Spirito, Siena. Front of the panel before restoration.

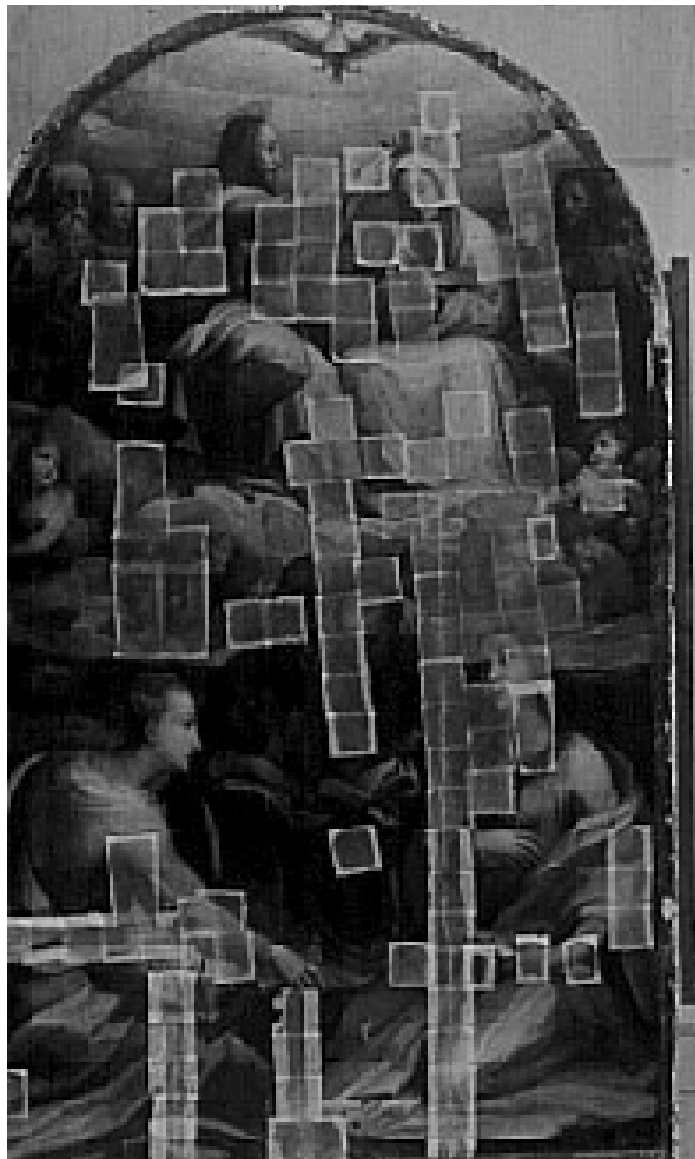

Diagnostic studies

To arrive at a precise understanding of the painting's support, it is important to analyze the consistency of the wood and to establish with certainty the various construction phases. Radiography and infrared reflectography (IR) are deemed useful tools for studying these aspects of panel paintings. In general, radiography is the most effective analytical technique for examining the construction of the support and for identifying the state of preservation of the wooden material (Fig. 2). For painted works, however, the data this type of analysis can provide about the structural condition of the wood fibers are related to the thickness of the preparation and to the presence of pigments that are particularly opaque to X rays. The X radiograph of *The Coronation* reveals wormholes in the support, as well as their displacement close to the surface. This study also provided information on the characteristics of the preparation, which showed up as slightly denser in X rays of the lower section, a possible indication of a greater thickness and different applications of the ground. Above all, the study revealed the two-phase construction of the support. Naturally, this study was compared with visual observations, an evaluation of resistance to touch on the back of the support, and an assessment of the weight of the work in relation to the type of wood. IR also proved useful for studying the support, as it showed the preparatory image to be continuous between the upper and lower sections. Thus, even if the preparation had been applied at different times, the painting was conceived all at once.

Photographic documentation with diffuse and raking light revealed the state of preservation of the preparatory and paint layers. The same techniques allowed documentation of the structural condition of the support and the treatment carried out in the 1950s.

Construction technique

The painting, executed in oil on wood, measures 310 × 187 cm; it is arched in the upper section. There was no cloth present as an isolation layer between the wood and the preparatory layers. By 1540 such a

Figure 2
Domenico Beccafumi, *The Coronation of the Virgin*. Radiography of the lap joint.

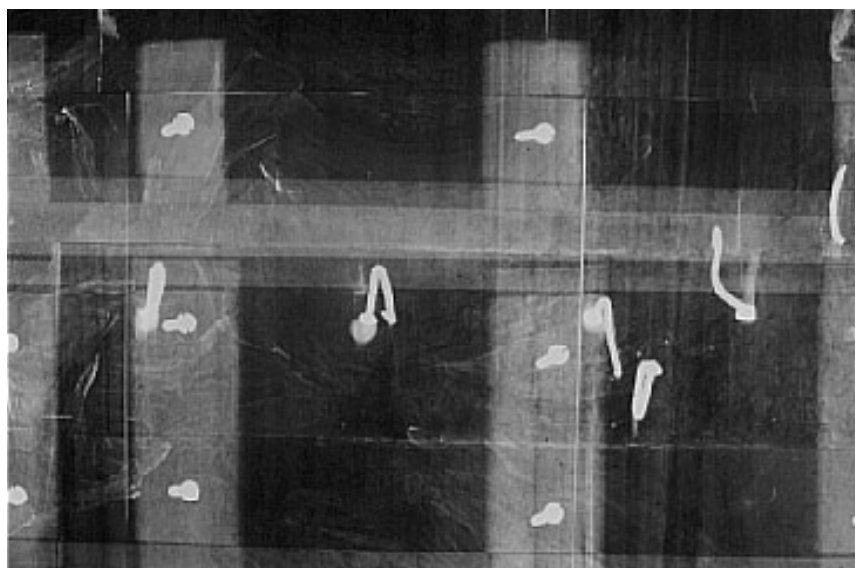
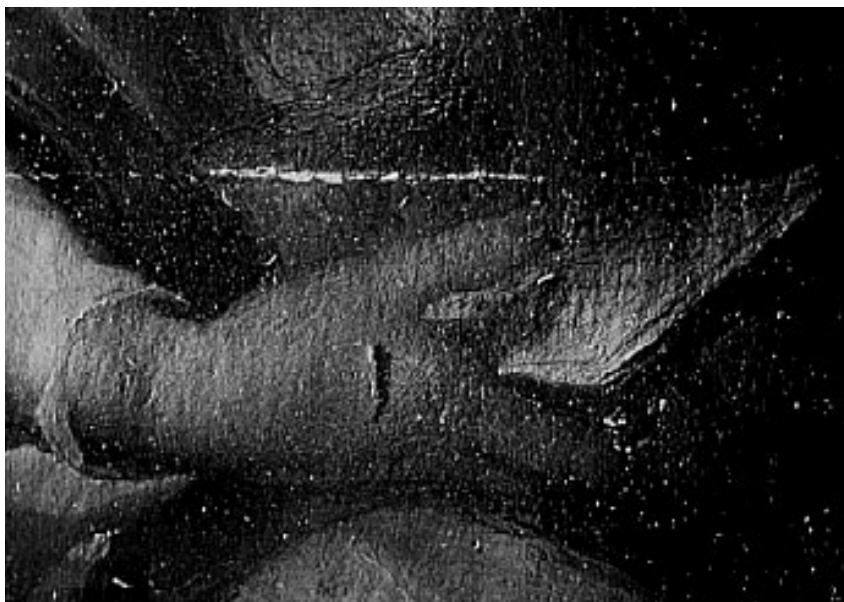

Figure 3

Domenico Beccafumi, *The Coronation of the Virgin*. Nail in the lap join of the painted surface.



characteristic isolation layer had fallen into disuse, as the construction technique for the preparatory layers no longer required the presence of the cloth as a buffer between the movement of the wood and the preparation.¹ The support is made of poplar—more precisely, white poplar (*Populus alba* L.)—and is formed of two distinct sections: an addition was made to the already existing support before the application of the paint layers. Thus, the support consists of two sections united with a 13 cm wide lap joint. The connection is reinforced with glue, as well as with nails that are driven in from both the front and back and bent under the preparation (Fig. 3). The upper section comprises five vertically oriented planks.² The tree ring pattern is subradial, the quality is good, and the presence of knots is rare. The lower section consists of six planks (also oriented vertically)³ of the same type of wood, with a medium tangential cut. The planks of the entire panel, according to the customary technique noted in the field of Italian panel paintings, are arranged with the internal side facing the preparatory layer; they are butt-joined and glued together with lime casein.

The variations in width of the planks in the two sections and the method by which they are joined give the impression that the two sections of the support may have been built at different times. It is certain that the extension was made before the paint was applied, because the painting presents a single pictorial composition, as revealed by visual and IR readings and chemical analysis of the pigments. Conversely, the preparation was carried out at two different times. This last piece of information, as already mentioned, is confirmed by radiographic studies that showed a greater density of the lower part of the painting, caused by the greater thickness of the gesso layer. Last, the ground and paint layers of the lower part are in better condition than those of the upper part. This is also true for the wooden support, whose condition can be attributed to the use of better-quality wood, which was almost certainly obtained from a different tree with denser fibers and greater resistance to attack by wood-boring insects. A shaped frame (which is not the original) was placed along the perimeter

on the surface, covering 7 cm of the original paint. The frame was held in place with screws, inserted from behind, that passed through the planks.

Apparently the back of the support had originally been sustained and controlled by three crossbars, each attached to the painting by five small wooden brackets that were fastened with glue and with nails driven in from the back and bent over on the front of the support. Both the nails that connect the lap joint and those used to attach the wooden brackets to the support are simply bent, hammered into the wood, and covered by the gesso preparation.⁴

State of preservation

Upon the painting's arrival in the laboratory, large-scale lifting of the preparation and paint layers was observed; this damage followed the grain of the wood in the main section of the panel (Fig. 4). The failure of the horizontal join on the back was also caused by the loss of extensive sections of worm-eaten wood that rendered several nails (those reinforcing the connection between the two sections) isolated and useless. On the front side of the area that corresponded to the join, a fracture affected the preparatory and paint layers. In general, various glued joints between the planks of the main support had opened. The stability of the paint layer was good in the lower section; cracks were noted exclusively along the joints. The state of preservation of the support appeared considerably degraded overall from diffuse attack by wood-boring insects that left the wooden material extremely fragile and weak in some areas. These conditions were worse in proximity to the vertical joins and the horizontal join between the two sections; the greater degradation there can be attributed both to the presence of protein substances from the glue and to the sapwood in the edge of each plank. The bottom section of the support did not show the harmful effects of the wood-boring insects. Its damage problems consist essentially of gaps in the joins caused by a greater contraction of these planks with respect to those in the upper part, and of a slight convex curvature of the surface. All the wood used for the previous restoration, particularly for the crossbars, had been extensively attacked by wood-boring insects, leaving the wood extremely weak.

Figure 4
Domenico Beccafumi, *The Coronation of the Virgin*. Lifting of the paint.



Figure 5

Domenico Beccafumi, *The Coronation of the Virgin*. Back of the panel before restoration.

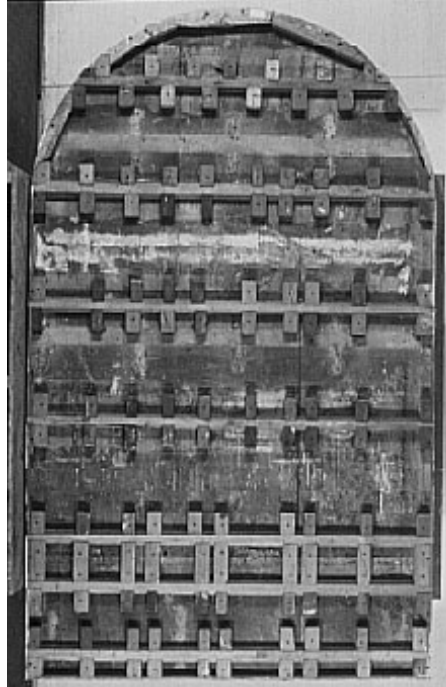

Previous restorations

The restoration work done at the beginning of this century was carried out with an invasive technique and with materials that were harmful to the preservation of the wood (Fig. 5). This method created conditions favorable to infestation by wood-boring insects and produced tensions within the structure, causing the deterioration of both the support and the painting. In previous restorations, the original crossbars had been removed, and the missing areas had been reconstructed with a paste of hide glue and sawdust.⁵ Also, seven crossbars made of cypress and plane-tree wood with an upside-down T cross section had been mounted to the support with large, notched wooden blocks.⁶ These elements had been fastened with hide glue and large screws. Poplar strips had been attached along the entire perimeter with glue, screws, and several nails hammered in from the front. This intervention—extremely invasive for the quantity of wood added and for the method and materials used—also made extensive planing of the panel surface necessary. This planing facilitated the exchange of moisture between the environment and the wood, a process that, in turn, favored a tendency toward deformation of the planks, which nevertheless was blocked by the interventions described above.

Another damaging intervention was the already cited application of the frame to the painting; the operations necessary to adjust the frame and hold it in place had produced twenty holes (each 6 mm in diameter) as well as six deep tracks into the painted surface (Fig. 6).⁷



Figure 6

Domenico Beccafumi, *The Coronation of the Virgin*. Marks in the painted surface caused by adjustment of the frame during previous restoration.

Restoration proposal

Given the severely deteriorated state of preservation of the wooden support and the ground, the following program was outlined:

1. Consolidation of the most degraded parts of the wooden material with acrylic resin (Paraloid B72).

2. Reinforcement of the addition by the insertion of several rectangular wooden pieces to hold the two parts of the join together.
3. Construction of two temporary crossbars to hold the painting during the removal of the existing crossbars.
4. Gradual removal of the existing crossbars.
5. Repair and correction of the separated edges by the cutting of tracks with a V-shaped section.
6. Leveling of the painted surface along the edges of the individual planks.
7. Exact fitting and placement of the wedge-shaped inserts, to be made of old wood (of the same type as the support), into the specially prepared V-shaped tracks.
8. Construction of a laminated oak framework that has a load-bearing function and also controls the deformation of the planks that make up the support.
9. Development of a plan for the microclimate control of the back of the panel.

Restoration interventions

Fumigation

The painting was fumigated in a gas chamber without vacuum, and then protected on the back with Permethrin, a fumigant that remains active.

Consolidation of the wooden material

Before the removal of the crossbars and the wooden blocks of the previous restoration, the join between the two sections of the support, which was in danger of separating, was reinforced. The technique used for this operation consisted of placing twelve rectangular inserts, made of the same wood as the support, on edge in the same grain orientation as the fibers of each plank, positioned across the horizontal junction. These inserts were distributed in the grain direction of the planks, penetrating the thickness of the support to within 5 mm of the painted surface. Thus the inserts reunited the two elements of the lap join.

One of the more problematic aspects of this restoration was the need to regain sufficient strength in the areas of the wood that were degraded by biological attack. The choice of consolidant was proposed in consideration of the uncertainties consolidants had generated in the past in the Florence laboratory; particular concerns were the efficacy of consolidants and their possibly negative effects over time. These concerns are tied to the stability of the product, possible color alterations, and nonuniform penetration into the wood (so that different areas of the wood are conditioned to respond differently to variations in RH). In this case, however, it was decided to use a 5–12% solution of acrylic resin (Paraloid B72) in lacquer thinner applied by brush until a sufficient consistency was reached. Before this operation began, all the hide glue and sawdust fillings were removed from the support, and two temporary crossbars were made. These crossbars were modeled to the curvature of the painted surface to support the panel adequately and make it possible to work on the back.

The removal of the wooden blocks that held the existing crossbars followed; this procedure freed the entire back surface of the support and prepared it for the initiation of the consolidation technique. Repair and

reconstruction of the structure proceeded with the reintegration of the missing parts of the support, in particular in the lap joint. For this operation, small blocks of old wood (of the same type as the support) were placed in superimposed layers that intersected in width and length (Fig. 7). The use of this method makes it possible to firmly bond the various wooden elements of the reintegration and, in addition, favors increased stability by reducing to a minimum the possible deformation of the added material.

The repair and rejoining of the separated joints and cracks were carried out by the cutting of triangular tracks into the support. These tracks conformed approximately in width and depth to the extent of the degradation in the areas of the join edges.⁸

The tracks were cut by hand with chisels (the traditional and effective method to rectify gradually the degraded condition at the edges of each plank), but wherever the consistency of the wood was good and the split was straight, an extremely narrow, cone-shaped router bit (5 mm maximum diameter) was used in order to remove as little original wood as possible.

Successful experiments had already been performed with this bit, made expressly for our laboratory, on samples that simulated V-shaped openings in panel paintings. As usual, in the preparation of the wedge for gluing, the surface levels along the joins and splits were aligned with the help of wooden levers. These wooden levers bridged the edges of the fractures and were adjusted with screws and wooden blocks. This step was followed by the fitting of the wedges, which were made from old wood (the same type as the support). Care was taken to ensure that the positioning of the grain was consistent with the grain at the edges of the opening. During this work phase, the undulation of the painted surface, caused by the curvature present in the two central planks, was slightly corrected, so that part of this deformation was distributed over the entire width of the painting. This operation has been shown to be useful in reducing the deformations visible near the joins and in improving painting readability.⁹ The correction of the edges produced an average curvature of 9 mm over the entire painted surface. It is not useful to plot deformation measurements without considering the ambient RH, because the wood is in constant equilibrium with the surrounding microclimate and consequently

Figure 7

Domenico Beccafumi, *The Coronation of the Virgin*. The integration of missing parts in the support with blocks of old wood.



Figure 8

Example of the mechanism that attaches the framework to the painting support.

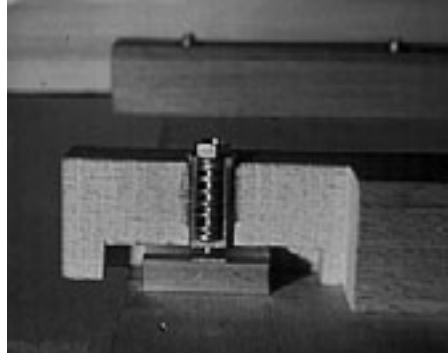

continually modifies its warp. The RH considered suitable to ensure the stability and uniformly flat surface of the wooden support varies between 55% and 60%. A polyvinyl acetate (PVA) emulsion was used to adhere the wedges, since its strength and moderate elasticity enable it to adapt better than other glues to the conservation needs of wood.

Support control system

After repair and reconnection of the joins, reconstruction of the missing wood parts, and reinforcement of the junction of the lap join, the support appeared quite solid. The only remaining phase was the construction and mounting of a crossbar system to control and reinforce this particular construction.

The author selected a system that could simultaneously respond to the expansion and contraction and, in addition, serve as a sound reinforcement, assuming the role of a true load-bearing structure. A perimeter strainer, or framework, was built with crossbars made of laminated oak from Slovenia. The crossbars had the same 9 mm curvature as the support, so that the strainer would conform to the shape of the panel. The framework was attached to the support without leveling of the back surface. Instead, small wooden spacers were inserted at the attachment points where the contact between the two parts was not perfect. A special mechanism to unite the two parts allows for potential expansion and contraction of the support and regulates possible warping of the planks. This mechanism consists of a brass shoe in the form of a closed U-channel section, held to the back of the support with a single screw (Fig. 8). Inside this U-channel section glides a nylon slide with a bolt at the center. The bolt passes into the framework through a brass sleeve, in which there is a spring regulated by a nut.¹⁰

The invasiveness of this mechanism to the painted support is limited to a single screw for each element. The presence of the spring between the support and the framework facilitates the regulation of stress and possible slippage between the two parts, as well as reduces tension. Designed to respond to problems of tension and deformation that may appear over time, the mechanism is extremely simple and does not require any intervention to the support (Fig. 9).

The selection of a means of deformation control with a framework system goes against the concept of the traditional crossbars, which act as a load on the support. Instead, the framework is a load-bearing structure to which the painting is anchored by means of attachments freed from mechanical tensions. In addition, if the RH of the exhibiting environment is uncertain, the framework makes it possible to enclose the back of

Figure 9

Domenico Beccafumi, *The Coronation of the Virgin*. Back of the panel after attachment of the framework for support and deformation control.



the panel easily. This enclosure creates a volume of air that slows climatic exchanges with the environment, thus facilitating stabilization. At the end of the intervention, the support is protected actively by a brush application based on Permethrin. The protection of the reverse is completed with a mixture of beeswax (60%), paraffin (30%), and rosin (10%) applied with a spatula to form a surface film.¹¹ This treatment can prevent new infestations and slow the rate of air exchange with the environment.

Jesus and Saint Peter on the Water by Herri met de Bles

From 1987 to 1988, the author was involved in the restoration of three panel paintings from the Flemish school. These works by the painter Herri met de Bles (nicknamed “Il Civetta”) came from the Museum of Capodimonte in Naples. Two of the paintings presented conservation problems that also involved the wooden support. The following paragraphs describe one of these works with regard to its construction characteristics, its particular conservation problems, and the restoration intervention to which the work had previously been subjected (Fig. 10).

Figure 10

Herri met de Bles, *Jesus and Saint Peter on the Water*. Oil on panel, 26 × 37 cm. Museum of Capodimonte, Naples. The state of preservation of the panel before restoration.

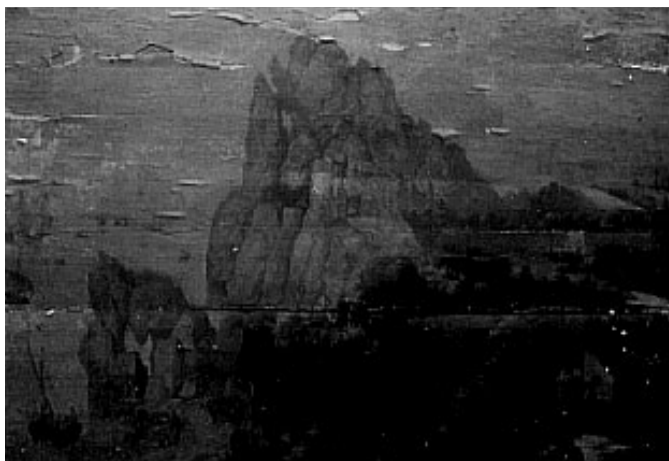

The restoration intervention that can address such conditions effectively requires special solutions in methodology and technique.

Diagnostic studies

Full-scale and detailed photographic documentation was carried out with diffuse and raking light. Raking light photography revealed the type and quantity of the lifting paint on the painted surface, as well as the support's deformation, especially in areas affected by cracks. Low-magnification observation was all that was required to identify the wood species, as the type of wood grain, the color, and the characteristic sheen of the parenchymal rays left no doubt about its identification as oak. While the RH was kept constant, relief drawings were made on graph paper to determine whether the curvature varied after the cracks were rejoined.

Construction technique

This small oil painting on panel consists of a single board of oak (*Quercus pedunculata* or *Q. sessiliflora*). The board has a straight, horizontal grain, with the tree rings positioned subradially. No knots or defects were noted in the support. Cloth was not used for the preparatory layers. It was clear that crossbars had never been used, both because of the painting's small size (26 × 37 cm and currently 3–4 mm thick) and because of the customary way supports were made in the Low Countries. In fact, for the great majority of these panel paintings, deformation is controlled and the wood fibers are supported horizontally and longitudinally simply by means of the frame. The frame had a channel routed in its thickness that made it possible to enclose the painting around the perimeter without restricting eventual expansion and contraction. A few exceptions to this rule employ reinforcement crossbars on the back.

State of preservation

The painting presented diffuse lifting of paint along the grain of the wood, as well as warping of the painted surface, which could be seen in three pronounced curves. At the edges of these deformations were two cracks that followed the grain, affecting the entire width. Although oak characteristically has a mechanical strength, durability, and resistance to wood-boring insects, the general conservation conditions were decidedly precarious. The wood, especially along the borders, was eroded and friable. The diffuse attack of wood-boring insects had produced many cavities, some of which had a diameter equal to half the thickness of the support. The weakened mechanical resistance of the support fibers was aggravated by a crossbar system that presented two drawbacks: it was extremely rigid in comparison to the size of the painting, and it functioned as a brace at a distance of only about 5 mm from the plane of the support. The planing of the back of the support contributed to the deterioration of the panel by causing the loss of the surface "skin" of the wood, so that a more rapid exchange of moisture between the support and the environment was encouraged.

Previous restoration

The last restoration of this painting occurred in the early 1950s. At that time, consolidation of the ground and paint layers, cleaning, filling of



Figure 11
Herri met de Bles, *Jesus and Saint Peter on the Water*. Back of the panel upon its arrival in the laboratory.

losses, and retouching were done. The back of the support had been planed down, a procedure that removed a small amount of wood. Three mobile crossbars were attached to the panel with poplar blocks, positioned in line with the grain of the panel, and glued in place (Fig. 11). The crossbars were circular-section aluminum rods that passed through holes made in the blocks attached to the support.

Restoration proposal

The following solutions were identified: removal of existing tension in the support; consolidation of the ground and paint layers; repair of the wormholes that had weakened the wood; and development of a sound support and control system for the panel. All of these operations had to take place with minimal invasiveness to the support—in accordance with a philosophy that is increasingly valued in the Florence laboratory. In this particular case, it is apparent—given the small size of the support—that excessive use of wooden material and glue could potentially damage the painting over time.

Restoration interventions

With the painted surface protected by Japanese rice paper and rabbit-skin glue, the consolidation of the paint layer was carried out by the vacuum technique with the same type of glue in a different concentration.¹² Two temporary crossbars were constructed to hold the painting in its current deformed state. A gouge was used to remove the supports that held the crossbars added during the previous restoration, thus liberating the support. While the temporary crossbars held the support orthogonal to the grain, the cracks were repaired by small V-shaped tracks opened with the traditional chisel method. With this operation, the two faces of the cracks were aligned and prepared for the wedges, and the painted surface was leveled. This initial phase was essential in giving the disjointed and deformed front faces a uniformly flat surface. It also made it possible to rotate slightly the disconnected edges of the cracks, while still preventing the back edges of the cracks from touching. In this way the panel took on an uninterrupted surface in correspondence with the cracks. To arrive at this solution, the painting was inserted into a special cagelike structure in which the correction of the warp and the alignment of the edges was begun (Fig. 12). This structure, built especially for this project, makes it possible to enclose the painting at the bottom, top, front, and back. The author and others were able to work on the edges of the opened cracks and adjust the levels of the painted surface by means of screws (the heads of which are protected by wooden caps) that can slide inside the vertical slats of the cage structure. With the aid of this system, the temporary crossbars were removed and the profile of the painting corrected. After this procedure, the wedges made from old oak were fitted, in correspondence with the orientation of the grain, and a PVA emulsion was used to hold them into place. This operation was repeated with the other crack.

The holes caused by the wood-boring insects—the problem that posed the greatest threat to the structural soundness of the support—were rebuilt with inserts made from the same type of wood as the support. Triangular or rectangular inserts—depending on the shape and depth of the holes—were held in place with PVA emulsion.

To restore solidity, control, and protection to the edges of the painting, a perimeter framework was made with the same curvature as the

Figure 12

Temporary jig for adjusting the surface level.

*Figure 13*

Spring attaching the framework to the support.

back of the support, and a central crossbar was installed. The framework, made of chestnut, was anchored to the support with nine springs. The springs were attached to the framework on one end and to the painting on the other end with an equal number of small blocks ($9 \times 9 \times 4$ mm thick). These blocks, made of the same type of wood as the support, were created with a hole to house the end of the spring. They were attached in the direction of the grain and glued in place. The blocks were placed inside the framework, and a nearly 2 mm space perpendicular to the grain was left to allow for possible expansion of the panel. Elastic control of the warping is provided by the springs, primarily by those positioned in conformity with the central axis (Fig. 13). Thanks to its solid and stable construction, the framework protects the edges and provides a secure support for the panel. This type of construction to control movement of the support does not put any weight on the panel, as do traditional crossbars. Instead, the panel is supported by anchor points distributed over the surface. Because of the reduced size of the framework—corresponding to the small size of the artwork—and the small blocks glued to the support, which allow the springs to connect the framework to the panel, it is possible to reduce substantially the invasiveness of the intervention (Fig. 14).

In future conservation efforts, it may be possible to adjust the tension in the springs without tampering with the anchor points of the support. This use of springs to control deformation is best applied to supports that consist of a single board, as independent deformation of other boards is not a factor. This structure can be closed on the back; the backboard creates a volume of air that functions as a buffer, slowing RH variations. The wood used can be of the same type as the painting support. Such a device, already described in the preceding intervention, slows climatic exchanges between the back of the support and the environment. Because of the small size of this painting, the back enclosure also provides increased stability to the support, augmenting the wood mass by filling up the framework's two cavities. To make this possible, the wood put inside the framework must be oriented with the grain of the panel and placed so that it is completely independent of the panel. Naturally, the restoration of the support also protects the back from wood-boring insects.

Figure 14

Herri met de Bles, *Jesus and Saint Peter on the Water*. Back of the panel, with the framework for support and deformation control in place.

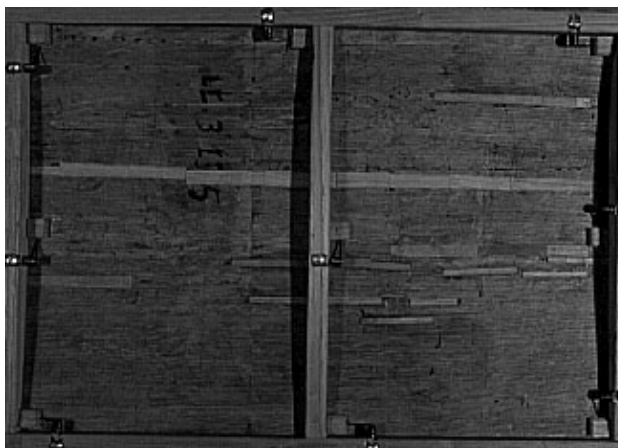

The Deposition from the Cross
by Francesco Salviati

This panel painting (495 × 285 cm) is executed in oil on panel and was painted around 1547–48 for the Dini Chapel in the Church of Santa Croce in Florence.

Diagnostic studies

The analyses done in preparation for the restoration of the wooden support consisted of measuring the moisture content in the wood. This was accomplished with the aid of probes attached to the planks (other probes measured the RH in the surrounding environment). All the probes were connected to a computer. The aims of this survey were to establish the relationship between the wood and the environment and to determine the importance of the reaction of the support to variations in these values. For this inquiry, a gauge was used that made it possible to obtain the values of the horizontal expansion with a centesimal scale.¹³ For the curvature, the control was simply a reference plane. Traditional photographic documentation of the condition of each plank was carried out. Particular attention was given to the parts of the painted surface that were affected by such problems as lifting paint, detachment of the original inserts (originally placed to repair large knots), cracks, and defects in the wood. Finally, several interesting details of the original construction technique were documented. Identification of the wood species was made with macroscopic and microscopic studies.

Construction technique

The painting, which is arched at the top (Fig. 15), was constructed without cloth between the wood and the preparatory layers; strips of cloth are not even found along the joints. The support consists of six planks of poplar—more precisely, white poplar (*Populus alba* L.). The planks are of average size with solid and relatively straight grain.¹⁴ The exception is the second plank from the left (seen from the back), which presents a curvilinear grain. The planks are of a medial cut, and the fibers are generally arranged subradially at the edges of each plank, becoming tangential at the center. Two radially cut planks that contain the pith are an exception to this characteristic. Because the plank is wavy along the length, the surface level changes from one plank face to the other—high on one side of the joint and then high on the other side. In addition, a considerable number of large knots, which have had a negative impact on the preparatory layers,

Figure 15

Francesco Salviati, *The Deposition from the Cross*, 1547–48. Oil on panel, 495 × 285 cm. Church of Santa Croce, Florence. View of the front of the panel shows the separated planks before wood restoration.

*Figure 16*

Francesco Salviati, *The Deposition from the Cross*. Side view of the plank, showing parts of the original floating tenon and the diagonal scores made to improve the hold of the glue.

were noted. Because of these defects, many planks were repaired during the original construction with the application of plugs of wood (also of white poplar) held in place with hide glue and nails. The assembly of the planks was achieved by butt-joining and accurate planing of the faces to be united. Diagonal scratches were also made, to improve the bond of the glue. Housings were carved inside the thickness of the planks, in proximity to the joins, in which floating tenons were inserted (Fig. 16).¹⁵ These elements of joining between the planks, regularly spaced in height on the painting, are made of walnut and have a rectangular shape. They were inserted without glue into the housings with the grain perpendicular to that of the support, and held by dowels that pass through the thickness of the planks. Three fir crossbars that tapered in length were mounted on the back and inserted into dovetailed tracks cut into about one-third of the thickness of the support. The panel is relatively thin for its size and undergoes only light restraint from the crossbars. It was discovered that in real-

ity, the large carved and gilded frame that held the panel not only served an aesthetic purpose but had a structural function as well.

State of preservation

The painting had been immersed during the flood of 1966 in Florence. During this time, the water, which was full of various materials, covered four-fifths of the altarpiece for approximately eighteen hours. In the Museum of Santa Croce, the panel was immediately protected with tissue papers of various sizes that were made to adhere to the surface with acrylic resin (Paraloid B72). Next the painting was moved to the *limonaia* in the Boboli Gardens, where the humidity of the environment was purposely kept at 90–95% to protect flooded artwork. The negative effects of the immersion on the planks are well known; the initial reaction was an expansion of the surface, after which the preparation and paint layer were loosened by water. During the next phase, the various materials within the painting dried at different rates, causing detachments and the overlapping of the panel's preparation and paint layers during shrinkage.

The initial papering done on site was repeated several times while the painting was sheltered at the *limonaia*. The first intervention on the wooden structure was the mechanical removal of the original crossbars.¹⁶ Before this operation, the painting was laid flat and faceup on a wooden structure that made it possible to work from below. Rectangular wooden blocks applied to the back bridged the joins and attached to the planks by two screws on both ends of the blocks. This served to reinforce the joins in order to hold together the planks that made up the painting. When it was brought to the laboratory at the Fortezza da Basso in June 1967, the panel was already separated at the joins, with the exception of a small part in the upper right of the last plank. The entire structure remained united only by the floating tenons that were left in the housings and held by the dowels placed at the ends of the tenons. There were convex warps on the painted surfaces of the planks, and two of the lower planks had become concave and twisted in the longitudinal direction. The preparatory layers were extremely deteriorated and unstable. The plugs placed to repair the knots exhibited their own deformations: they had detached from their housings and marked through onto the painted surface (Fig. 17). The particular characteristics of the deformations in this painting—related to the

Figure 17
Francesco Salviati, *The Deposition from the Cross*. An original plug present in the painted surface; it had come unglued during the panel's immersion in floodwaters during the flood of 1966 in Florence.

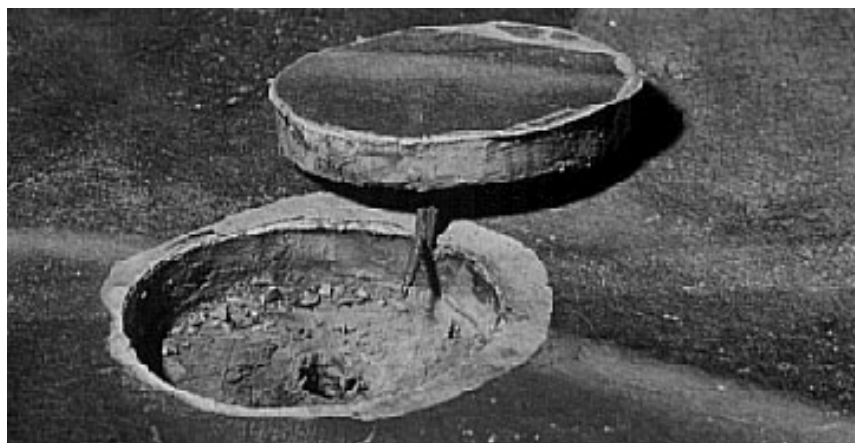

direction of the grain—manifested themselves in two planks that were simultaneously concave at the bottom and convex at the top.

Restoration interventions

The painting was followed through its stabilization phases for many years. During this time, thorough consideration was given to possible working solutions for consolidating the paint layer, guaranteeing sufficient stability, and restoring the lost unity of the entire work by the application of a support and control structure for the planks.

The traditional intervention technique often used in such cases involves destroying the wood and transferring the paint layer to another support, incurring all the changes and risks connected to this type of operation. In this case, however, the conservator followed an intervention that would respond to the criterion of greatest possible respect for the original components and that would, in addition, allow the possibility for a later intervention. After evaluating the results on the consolidation of the paint layer, the author and coworkers designed and carried out the restoration of the support. This plan required an intervention on each individual plank to repair the original detached and disjointed plugs, upon removal from the painted support, by cutting the anchoring nails. Next came the addition of wooden blocks into the housings of the plugs in a parquet fashion (Fig. 18).¹⁷ This procedure was followed by a reduction of the thickness of the plugs to facilitate reestablishment of the level between the blocks and the surface of the painting.

Each section was adhered again to its own place, so that the proper level between the edges of the paint layer was re-created (Fig. 19). The wedge technique was used to close the cracks at the edges of the planks. Finally, the author inserted into the original tracks of the crossbars a double layer of small pieces of white poplar, placed in the same grain direction as the support.

Filling the original tracks with a double-block system superimposed widthwise and, especially, lengthwise, responded to the need to improve the adhesion between the added parts and the original panel, particularly in the areas where there is an end-grain join (Fig. 20).¹⁸ Next the planks were rejoined through a slight correction of the edges, so that a solid union could be obtained by means of wedges.¹⁹ For this operation the

Figure 18, below
Francesco Salviati, *The Deposition from the Cross*. Repair of the housings and plugs.

Figure 19, below right
Francesco Salviati, *The Deposition from the Cross*. Treatment to re-create the proper level between the edges of the paint layer.

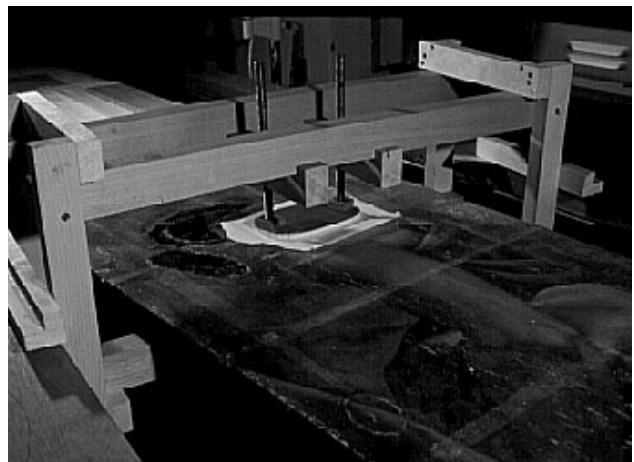
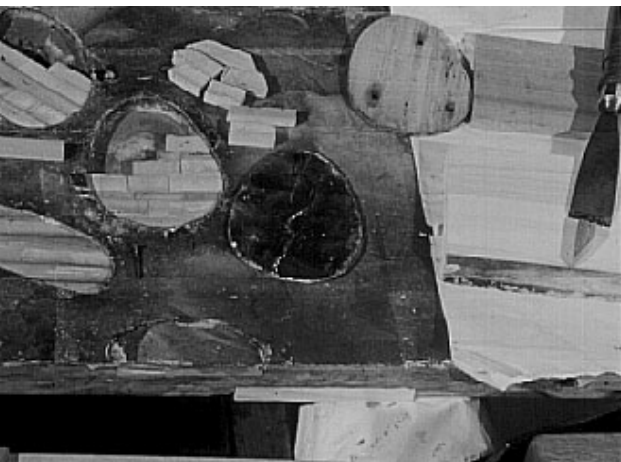
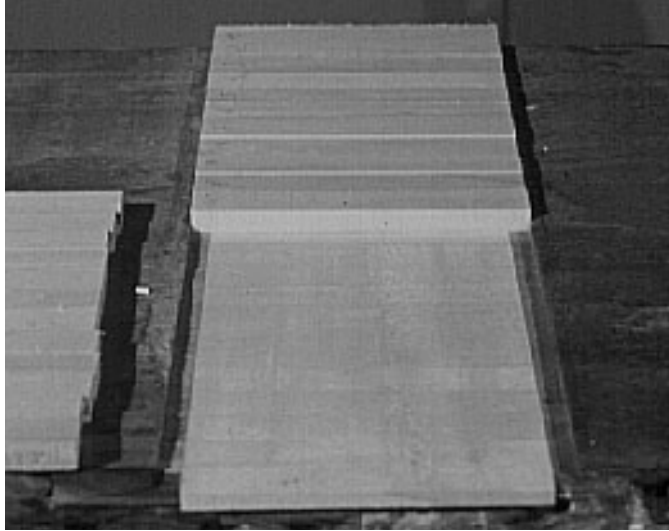

Figure 20

Francesco Salviati, *The Deposition from the Cross*. Wood-block system used to fill in the tracks of the original crossbars.



author aligned the planks according to a regular curvature that followed the individual deformations of the planks and that took into account both the visual unity of the work and its structural needs. This operation was of critical importance and required a lengthy time for study and the preparation of different simulations to help determine the proper equilibrium between the deformations of the individual planks and the general curvature that derives from them. When the correct equilibrium was reached between the curvature and a good visual unity of the work (with its placement in the original frame considered), two temporary crossbars were made that served as a reference during the final assembly phase.

Another difficulty was the need to bring together at an equal level the painted edges between the individual deformed planks. Through observation of the defects that emerged in this painting, it was possible to confirm that the deformations that appeared are not casual ones but clearly respond to the composition and direction of the grain and, more particularly, to the arrangement of the tree rings in the planks. This information also confirms that the planar stability of a painting hinges on a careful selection of wood at the time of construction.

The author and coworkers then began work on rejoining the panel from the two central planks, starting from the center and moving toward the outside, using the already described crossbars as a reference, and proceeding gradually both with the leveling of the painted surface and with the gluing of the wedges (Fig. 21).²⁰ The remaining parts of the painting were reassembled with this same method (Fig. 22).

After this phase, a crossbar system was built that was identical to the original in both the kind of insertion used for the crossbars and the mode of function. This system, which appropriately limits the expansion and deformation over the entire surface, seemed the most suitable for the state of conservation of the pictorial surface of this particular work. Movement is controlled by the friction encountered by the crossbar within the tapered, trapezoidal shape of the track in the support (panel). Conversely, the elasticity of appropriately sized crossbars controls deformation. To function appropriately, the crossbars were made with a curved profile, part of a circle that follows the curvature of the support. This

Figure 21, right

Francesco Salviati, *The Deposition from the Cross*. Reassembly of the planks.

Figure 22, far right

Francesco Salviati, *The Deposition from the Cross*. Reassembly. Seen from the front.

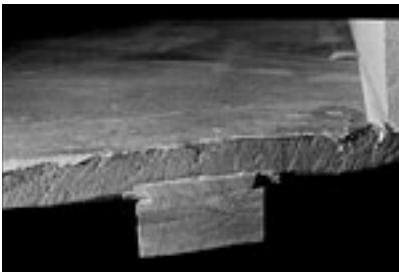
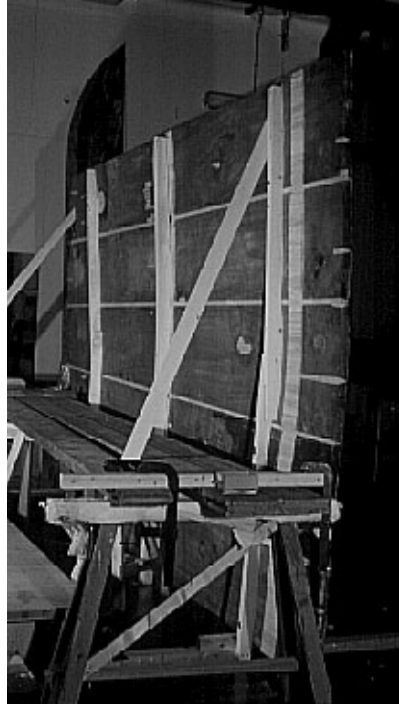
*Figure 23*

Francesco Salviati, *The Deposition from the Cross*. End view of the inserted crossbar.

operation was accomplished with the double-block system used in the tracks of the original crossbars. The original tracks were widened into a new track, which maintained the trapezoidal section of the original. The new crossbars were made out of laminated oak assembled on a preconstructed negative form; they were fashioned with the same curvature as the track in the panel (Fig. 23). The crossbar dimensions were determined by the large size of the entire work and by the design's likely stability over time. The frame will regain its important structural function, completing the support of the painting as it did originally.

The back of the painting was next protected with a thin coating of beeswax, paraffin, and rosin spread on with a spatula. Isolation from the environment was further guaranteed by placement of the work inside the original frame and installation of a backboard. This feature will make it possible to improve the climatic factors in contact with the support.

The Annunciation by Lorenzo Monaco

One additional example completes the presentation of the various operating methods that can be applied to the restoration of painting supports. Changes are not introduced for their own sake but as a study of solutions to the problems of individual works. This flexible attitude is vital and is based on the understanding that every intervention that changes—even a little—the original construction, if not required by the state of preservation of the work, is to be considered a loss of evidence and cultural patrimony. The restoration presented briefly here was recently concluded on the triptych, *The Annunciation*, by Lorenzo Monaco (Fig. 24). This work was executed in the period from 1424 to 1425 for the Bartolini Salimbeni family; it came from the Church of Santa Trinità in Florence, where it had been installed in the fourth chapel on the right side of the nave. As with the preceding examples, the particular choices that governed the

intervention follow the rule of respect for the original construction while also providing an appropriate functionality to the support and conferring the best stability to the paint and preparatory layers.

Diagnostic studies

With regard to the wooden construction of this painting, the current state of preservation and the deformations present in the panel were documented. The construction technique was analyzed and the wood species identified.

Construction technique

The painted panel (265 × 236 cm), with three cusps in the upper part, consists of a support of seven planks made of white poplar oriented with the grain in a vertical direction and butt-joined with lime casein glue (Fig. 25). Inside the joins, at the center of the thickness of the planks, are wooden dowels that connect the planks. Most of the planks were obtained with medial cuts; only the central plank was radially cut. The technique for the painting preparation uses a cloth and a thick layer of gesso and glue; the painting medium is egg tempera. On the upper part of the panel front, there are also cusps superimposed on the main plank, with carved ogival framing elements that contain, inside tondi, the figures of God the Father and the prophets. Below, there is a small predella with inscriptions. The work itself rests on a larger, stepped predella, where scenes from the Nativity are depicted.

The support is reinforced on the back by three crossbars of poplar, placed at right angles to the panel planks and fixed with nails, which were driven in from the front prior to the preparation and then bent over on the back of the crossbars. The small predella at the lower edge of the painting is made of a board placed at a right angle to the grain of the support and fastened with nails.

Figure 24, below
Lorenzo Monaco, *The Annunciation*, 1424–25.
Egg tempera on panel, 265 × 236 cm. Church
of Santa Trinità, Florence. Photographed in
raking light.

Figure 25, below right
Lorenzo Monaco, *The Annunciation*. Back of
the panel photographed in raking light.





Figure 26
Lorenzo Monaco, *The Annunciation*. A split on the back of the panel; some ring separation is evident in the wood of the support's central plank.

State of preservation

The planks that make up the support show slight convex warping on the painted surface. This phenomenon is greater on the outside planks, and on the painted surface, a pronounced misalignment is noted at the open splits. The central plank, from a radial cut, shows separation of the tree rings in correspondence with the pith. The phenomenon of ring separation (the “onion effect”) is typical for chestnut but rare in poplar (Fig. 26). Finally, the joins were open, and cracks were noted in the bottom part of the support.

Previous restorations

The last restoration carried out on the painting dates from the 1950s. On that occasion, the paint layer was cleaned, and the gesso that had been applied on the gilding of the architectural part was removed. To restrain the planks that had separated, butterfly inserts were inset across the joins. Some of the planks of the support were warped, so that a double convex deformation was formed across the painted surface. To lighten the tension in the planks, the crossbars were reduced in thickness. The upper one was thinned though not removed from its housing, while the central one was removed by the cutting of its original nails; it was then thinned and put back into place with normal screws. Finally, in the case of the bottom crossbar, it could be seen that the nails had been straightened and the crossbar slipped off, reduced in thickness, and reattached with the same elements, since the heads of the nails could be reached by removing the smaller predella.

Restoration proposal

The plan for the intervention was established after careful evaluation of the condition of the painted surface, the consistency of the wood, the uneven surface alignment at the splits, and the hold of the crossbars.

The removal of butterfly inserts was justified in that their function is only partial, and, in fact, they are even harmful, since the grain is placed in the direction opposite to that of the support, so that tension points are created between the planks.

The following were planned: repairing the splits with the wedge technique, adjusting the surface level at the splits, overhauling the crossbars, and protecting the back with an antiwoodworm product based on Permethrin.

Restoration interventions

By use of an electric router attached to a pantograph template, the walnut butterfly inserts were removed. This made it possible to obtain the perfect refacing of the cavities on both the edges and the bottom. In this case the author felt that the slight vibration of the instrument would be well tolerated by the support and by the entire, rather solid preparation-paint layer. The cavities were corrected and filled with small elements of old wood of the same type, and arranged in the same grain direction, as the support.

The separated edges of the joins and cracks were repaired with the traditional method: triangular-section blocks were custom-fitted into



Figure 27

Lorenzo Monaco, *The Annunciation*. Ring separation in the wood on the back of the panel before repair. Also visible is the reconstruction in the grain direction of the old butterfly inserts.

prepared tracks and glued in place with a PVA emulsion.²¹ The degraded part of the wood was eliminated by the correction of the edges, and the level of the painted surface in those areas was realigned.

In this operation our intervention was limited to removing only the parts affected by degradation, so that, as much as possible, the triangular angle of the cut was retained. It was considered vitally important that each wedge be positioned in such a way that the grain be parallel to that of the panel and that the annual rings be arranged radially with respect to the plane of the support. Such positioning is more compatible with the wooden construction and, in case of dimensional changes, guarantees less deformation and, thus, a greater bond to the support. The most difficult part of this operation was the repair of the onion effect seen in the central plank (Fig. 27). The author and coworkers thus proceeded with the removal of the wood affected by the phenomenon, following its irregular disposition. The intervention was carried out in multiple steps, by alternating opening, leveling, and gluing of blocks in many layers for the reconstruction of the weak parts. Then wedges were inserted to join the faces of the opening. This technique made it possible for the surface to be perfectly adjusted: the multistep integration reduced the forces in the wooden material, lending greater stability to the intervention. Even the leveling of this area had to be done in different phases to obtain good results without the application of especially strong force. The solution adopted for the crossbars followed the concept used in the previously described intervention—that is, to make modifications only in the bonds between the various components.

The method of reducing the rigidity of the crossbars is altogether valid today when the panel's planks are subjected to a warping stress that is thought to be irreversible. Such situations generally are the cause of the formation of cracks and instability of the paint and preparatory layers. These phenomena can be caused by the aging of the material in relation to the characteristics of the wood in terms of quality and positioning of the grain, or by environmental factors that have affected the life of the painting.

Removal of the upper and lower crossbars proceeded with the cutting of the tips of the nails that were hammered over onto the back. This operation made it possible to observe that two sides of nails had some space in the horizontal direction as a consequence of the yielding between the parts (the walls of the wood and the flexible metal) that occurred over time. The next step consisted of widening the holes left by the nails in the crossbars (by 3 mm) and threading (with a 4 mm pitch) the uppermost centimeter or so of the nails that protruded from the support for the entire thickness of the crossbars. The crossbars were then inserted onto the protruding nails. Because the crossbars had been thinned on the back to a thickness of a few millimeters, it was possible to reconnect the crossbar to the support in a stable manner with a nut. For the central plank, which was missing the original nails, a mechanism was used that consisted of a brass stop plate with a rectangular slot inside, held onto the lower face of the crossbar in contact with the panel with two screws and epoxy resin; a bolt was free to move within the slot but was held in by its head. A double-threaded brass bushing was inserted into the support—the external thread to anchor the bushing to the support, the internal thread to receive the bolt. The bolt passes through a hole made into the crossbar and attaches itself to the support. Movement is ensured by the head of the

Figure 28
Model of the anchoring system used for the
central and lower crossbars.



screw, which is held by the slot of the stop plate, and is aided by the interposition of two convex washers and one Teflon washer (Fig. 28).

Choosing to remove the existing crossbars in this case is based on a study of the equilibrium between the crossbars and the support planks, and on the stability of the paint and preparatory layers. It did not seem appropriate to intervene with new crossbars, even if they would function better, because of the risk of disturbing the existing equilibrium. The chosen intervention—which was believed to be sufficient to guarantee the solidity of the structure—preserved what remained of the original crossbars, limiting the intervention to reestablishing the integrity of the support with the repair of the cracks. This operation interrupts the circulation of the microclimate through the openings present between the planks, guaranteeing greater stability. Naturally, taking appropriate precautions for the painting's exhibition in the church, preparing a microclimate analysis of the environment, and establishing the appropriate interventions are necessary.

Acknowledgments

Restoration of the works presented here was carried out at the Opificio delle Pietre Dure e Laboratori di Restauro by the following individuals: Dr. Marco Ciatti, director of the work; C. Castelli, M. Parri, A. Santacesaria, R. Buda, P. Bracco, O. Ciappi, N. Bracci, T. Cianfanelli, and M. Rosa Sailer, restorers for the wooden supports and painting; Dr. A. Aldrovandi, reflectography studies; Dr. A. Aldrovandi and O. Ciappi, radiography studies; C. Castelli, M. Parri, and A. Santacesaria, 35 mm photography; Sergio Cipriani and Lamberto Cerretini, archive photos; A. Santacesaria, AutoCad designs. I thank the many colleagues and friends who collaborated on the work presented here—in particular, Dr. Giorgio Bonsanti, superintendent of the OPD, Dr. Cecilia Frosinini, and Dr. Marco Ciatti for their collaboration in outlining this article. Further thanks to my friends Andrea Rothe and George Bisacca for helping with the translation from Italian.

Notes

- 1 The use of cloth for the preparation of panel paintings is noted from 1138 (Croce di Sarzana) until the early 1400s. This element reduces the effects of settlement and movement of the support wood, helping to preserve the preparatory and paint layers. A heavy layer of gesso and glue several millimeters thick is added. This technique is described by Cennino Cennini in his *Libro dell'arte* (ca. 1437). After this period and throughout the 1400s, cloth or parchment strips were applied on many panel paintings in correspondence with joints, nailheads, and imperfections in the wood.

- 2 The widths of the planks that compose the upper support measure as follows, starting from the left: 21, 46.5, 56, 49, and 13.5 cm.
- 3 The widths of the planks of the support's lower section measure as follows, starting from the left: 15, 38.5, 31, 40, 33, and 28.5 cm.
- 4 Of the several ways to guarantee that the heads or tips of nails do not contact the preparatory layers, the most suitable method recreates a uniform support surface for the preparatory layers by recessing the nail a few millimeters into the thickness of the support and then covering it with a wooden plug. This method is most prevalent in the oldest works. In less careful preparations, pieces of cloth or parchment were applied with the aim of isolating the metal.
- 5 A mixture of paste, made with hide glue and sawdust, is frequently found in restorations of painted wooden supports. This mixture shrinks in volume over time. The shrinkage produces a tension in the area where paste was applied and in the surrounding areas, causing stress in portions of the original wood that renders it weaker than before the application of the paste.
- 6 These crossbars were mounted in such a way that the attachment blocks also reinforced the join between the upper and lower parts of the support.
- 7 In the adjustment of the frame junctures, the various pieces had been cut directly on the painting, during which procedure the serrated blade scraped the painted surface.
- 8 The use of wedges for rejoining gaps and cracks in panels has already been treated by Giovanni Secco Suardo in the first chapter of his manual *Il restauratore dei dipinti* (1866). This system is still valid for the restoration operations described here. This method makes it possible to realign the disconnected edges and rejoin them perfectly through part or all of the entire thickness, depending on the support condition, without tampering with the preparatory and paint layers. With regard to destroying original material, it is important to limit such treatment reasonably to the areas of existing degradation: the smaller the area of wood treated, the greater the stability of the intervention. The wedge's positioning, both with the grain and with the annual rings, is important in obtaining the best stability between the panel and the added inserts. The wedges must be placed radially with respect to the plane of the support.
- 9 The correction of the overall curvature was carried out after the V-shaped tracks were cut, so as to prevent the back edges from pressing against each other during the correction and thereby spreading apart the painted surface.
- 10 The mechanism consists of a brass shoe in the form of a closed U at right angles; it is 3 cm long and 1 cm high and is held to the support with a screw. If the consistency of the wood is poor, a double-threaded brass bushing is used for attachment to the support; the external threading anchors to the panel and the internal threading receives the screw that holds the brass shoe to the support. This 1 cm diameter bushing is 1.5 cm high, according to the characteristics of the support, and is screwed and glued to the planks with epoxy resin. Inside this brass shoe glides a nylon slide with a screw at the center that is inserted into the thickness of the framework; the hole has a cylindrical brass sleeve that receives a spiral spring inside it; the upper end of the bolt is adjusted by a nut.
- 11 This type of intervention—even if it presents some difficulties with the possible removal of the wax from the back of the panel—was considered useful given the precarious stability of the painted surface.
- 12 The vacuum technique is very important for the consolidation of the preparation and paint layers; its use requires a deep understanding of the application method, which is related to the solidity of the support and to the particular characteristics of the paint.
- 13 The method used to carry out this measurement took advantage of a measuring device sufficiently sensitive to plot the movement of the object in response to variations in RH. The gauge is a suitable device for obtaining these measurements. Such an instrument—having a centesimal scale and a useful field of 10 mm—was modified for use by the attachment to each of the two ends (fixed and sliding) of a perpendicular support ending with a 3.5 mm steel sphere. On the back of the support, the reference couples were attached in a stable and easily removable manner. These consisted of nuts with an internal hole ground to 3.5 mm, glued with epoxy resin to three-prong thumbtacks that allowed the terminals of the sphere to be housed stably.

- 14 The painting's planks measure, starting from the left of the painted surface: 50.5, 47.5, 45, 50, 47.5, and 36 cm.
- 15 The floating tenon is a rectangular element of hardwood, often walnut; it works as a connection and reference point between the planks during gluing of the joins. Floating tenons are inserted in the housings without being glued and are held in place with one or two dowels per side inserted into the thickness of the planks. A wooden peg also has the same function, although it has a circular section.
- 16 For crossbar removal, the painting was laid flat on a wooden grill. With a portable circular saw, the crossbars were cut longitudinally from below through the entire thickness without damage to the support.
- 17 As described in the previous intervention, this method attempts to prevent the creation of fracture lines by the positioning of small blocks of the same type of wood, united together and staggered along the length.
- 18 First, blocks are inserted to four-fifths of the depth of the track in the original support. After the glue has dried, the upper face of the blocks is planed, a procedure that widens the track about 1–1.5 cm in the longitudinal direction of the wood fibers. Thus, the block applied to complete the plane with the support will be adhered to the surface of the panel in the direction of the fibers.
- 19 This method requires the planing of the edges by a slight angling of the utensil toward the back without its touching the paint edge. With such a system, the reunited planks create a V-shaped space to receive the wedge-shaped block.
- 20 The wedge, the central element of this operation, must follow specific criteria: wood selection, grain orientation, and leveling of the edges of the painted surface. Adjustment of the wedge in the housing is carried out in the traditional manner.
- 21 The term "traditional method" here refers to the opening of V-shaped tracks with a chisel, correcting the edges, straightening the faces, and adjusting the wedge in the V-shaped track.

Reference

- Secco Suardo, Giovanni
- 1866 *Il restauratore dei dipinti.*

Structural Considerations in the Treatment of a Nativity by Francesco di Giorgio Martini

George Bisacca

TO EXPLAIN THE APPROACH to the structural conservation of panel paintings described in this article, the author believes that it may be more useful to chronicle a single, complex intervention rather than catalogue the range of technical solutions employed for specific problems, because he considers the decision-making process related to a particular intervention to be the most critical factor determining its success. Obviously, an accomplished level of woodworking skills, knowledge of the properties and behavior of wood, and a general technical and mechanical versatility are important, but ultimately they are not enough to ensure the suitability of a proposed treatment.

The danger of approaching a structural intervention (or any restoration) from a purely technical point of view is that of unwittingly causing some kind of aesthetic shift inappropriate to the work of art in question. Many transfers, for example, can be considered technically successful but may have been executed at the expense of certain textural qualities in the surface. Conservators have sometimes been unqualified to judge the extent to which these subtle shifts compromised the overall aesthetic of the object and, ultimately, much of its meaning. Critical aesthetic judgment should be an essential component of any conservation project, as it provides the only means to evaluate the appropriateness of a proposed treatment in proper context. This ability is continually developed by broadening one's general art-historical knowledge, by closely examining and comparing similar works of art (particularly those in excellent states of preservation), and by learning how to predict the natural aging behavior of materials under various conditions. Building this kind of knowledge sharpens one's ability to deduce the fabrication methods and treatment history of an object accurately, prior to intervention; it also helps in projecting what kind of improvement can reasonably be expected.

Conservators who believe that aesthetic choices are subjective and therefore inappropriate relinquish their responsibility to understand the object in a larger context. Because visual acuity and the complexities of cultural context are limitless, one's current level of understanding is always inadequate; consequently, there is a danger inherent in all interventions. Since any intervention can potentially disrupt the aesthetic and physical integrity of the object, conservators are bound to consider both of these aspects in order to minimize the risk of causing some inappropriate shift.

In general, post-treatment environmental conditions should also be a factor in deciding the extent of a proposed treatment. For example, a

cradle that has blocked and caused splits in the panel in the past but is now housed in a stable environment may require no treatment, provided that the painted surface is acceptable and the exhibition conditions will not further aggravate the state of the panel. Finally, some consideration should be given as to whether the amount of risk involved in a proposed intervention is justified by the amount of projected gain.

Overview

In 1964 Federico Zeri published an article in *Bollettino d'arte* linking a *Nativity* by Francesco di Giorgio in the Metropolitan Museum of Art in New York with a fragment, *God the Father with Angels*, in the National Gallery in Washington, D.C. (Figs. 1, 2) (Zeri 1964). He recognized that, given the size of the Metropolitan *Nativity* (62.2 × 59.1 cm) and its likely date, the rectangular format was improbable. He suggested that, stylistically, the upper portion of the panel required an arched top, and that iconographic considerations would have dictated the representation of God the Father giving a blessing or, at the very least, some sort of compositional closure. The Washington panel furnished precisely these elements.

The oval format of the Washington panel had long been considered suspect. In fact, various additions to the lower edge could be discerned with the naked eye beneath the overpainted sky. Close examination of the Metropolitan panel revealed a horizontal addition of approximately 10 cm along the top edge.¹ Consequently, Zeri hypothesized that the two

Figure 1
 Francesco di Giorgio Martini, *Nativity*,
 1471–72. Tempera on panel, 62.2 × 59.1 cm.
 Metropolitan Museum of Art, New York.





Figure 2
 Francesco di Giorgio Martini, *God the Father with Angels*, 1471–72. Tempera on panel, 36.5 × 51.8 cm. National Gallery of Art, Washington, D.C.

panels were actually fragments of the same picture. Zeri's reconstruction was generally accepted in the literature and later confirmed by X radiography. It was not, however, until the planning stages of the Metropolitan exhibition *Painting in Renaissance Siena: 1420–1500*, held in 1988 in honor of John Pope-Hennessy's seventy-fifth birthday, that a decision was made to exhibit the pictures together.

The treatment of the panels evolved from the initial idea of minor cleaning and corrective retouching for the purpose of exhibiting the pictures side by side, to a major cleaning and structural intervention, which ultimately included the reconfiguration of the Washington panel into a lunette, the permanent rejoining of the two panels and, finally, joint ownership between the two museums.

The scope and objective of the intervention broadened several times during the process because of the emergence of new information that continually expanded the understanding of the work as a whole. New physical evidence uncovered at various stages pointed toward the need for increasingly extensive interventions that the conservators and curators concluded were justified by the prospect of real aesthetic gain with the least conjecture. At each step, intervention was limited to the minimum necessary to achieve a clearly attainable goal, based on structural and aesthetic integrity within the given context. As the context changed, the permanent rejoining became a more and more logical alternative; and it stands as a credit to the conservation, curatorial, and administrative staffs

of the National Gallery and the Metropolitan that the needs of the object were allowed to prevail at every turn.

Initial Phase

The rocks and bricks depicted in the addition to the Metropolitan panel had always appeared aesthetically unsuccessful. In light of the upcoming exhibition in which the two pictures were to be exhibited side by side, the Metropolitan decided to reconstruct the work more accurately in relation to the artist's original intention. The reconstruction was based on the information available in the radiograph taken in Washington, D.C., in the 1960s, shortly after the appearance of Zeri's article. Washington produced a new radiograph on more modern equipment that greatly clarified the original depiction, and the Metropolitan made adjustments that more accurately reflected the new information.

The National Gallery had not previously considered removing the overpaint in the sky because the outcome was likely to be even more confusing and difficult to resolve aesthetically. Since the new radiograph revealed much sharper and more extensive detail than was previously visible, however, the National Gallery decided that it was now worthwhile to remove the overpaint and expose as much of the original surface as possible (Fig. 3). The result was surprising, because the overpaint in the sky had obscured much of the exquisite detail in the depictions of the thatched roof and all of the brickwork in the lower fragment—elements that were

Figure 3

Washington panel after removal of overpaint by Sarah Fisher, head of paintings conservation at the National Gallery. The opacity of the overpaint had prevented much of the detail in the thatched roof and all of the brickwork in the lower fragment from reading in the radiograph.



not even visible in the new radiograph. The approximate positioning of the fragments outside the lower left and right of the oval was now clear. Enough new information was now available to consider returning the painting to a lunette format. The respective museums agreed not only to turn the Washington picture permanently into this format but also to remove the addition from the Metropolitan picture and to abut the two pictures one above the other in a single frame made specifically for the exhibition.

Removal of the Metropolitan Addition

The removal of the addition on the Metropolitan picture was relatively straightforward. The panel had been thinned to approximately 1 cm overall and heavily cradled (Fig. 4), and while many splits and surface distortions were present (Fig. 5), the panel showed no signs of recent movement. It was, therefore, decided to remove only as much of the cradle as was necessary to facilitate the removal of the addition. The grain of the addition was oriented horizontally, while that of the original panel was vertical. Close examination of the joint revealed an extremely asymmetrical tongue-and-groove joint (Fig. 6a). The upper lip of the groove section measured less than 1 mm thick, which is an unlikely configuration. It was speculated that this must have originally been a symmetrical joint, the sections of which measured 5, 6, and 5 mm, for a total of 16 mm (Fig. 6b), which is still too thin for an Italian poplar panel of this size. Based on comparison with other unthinned Sienese panels of this period and date, it seems more likely that the original thickness was between 2 and 2.5 cm. Once the panel was cut in two, it may have seemed unnecessarily thick. At this point, it was probably partially thinned (to 16 mm), and the addition, with a symmetrical joint, was added. At some later date, after slight warping, the panel and the addition were further thinned, probably to obtain a flat surface for the application of the cradle, leaving what for all practical purposes was a half-lap joint.

Figure 4, below

Reverse of the Metropolitan *Nativity*. The joint of the cross-grain addition can be seen just below the first crosspiece from the top.

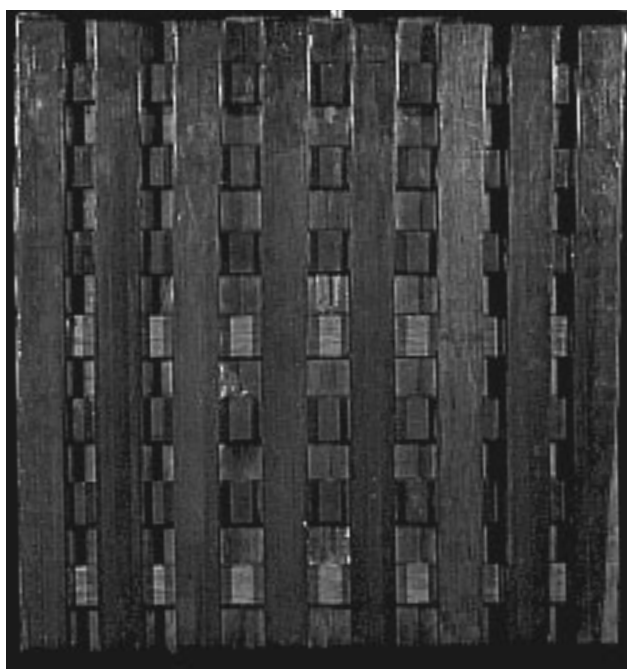
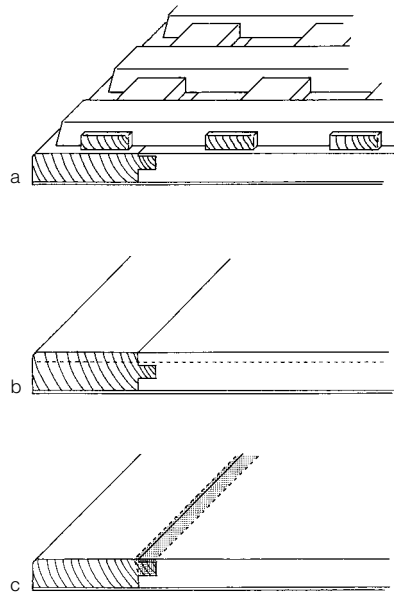

Figure 5

Raking light photograph clearly showing splits and distortions in the Metropolitan panel and the smooth surface of the addition.

Figure 6a-c

Metropolitan panel prior to intervention. Note (a) the extremely thin lip of the groove section toward the back of the panel, and (b) the presumed thickness of the Metropolitan panel at the time the addition was added; the dotted line indicates the thickness at the time the cradle was applied. After removal of the cradle (c), the shaded area was carved away by hand, leaving only one weak, end-grain bond between the addition and the original panel.



Because of the inherent weakness of any end-grain bond (especially with hide glue), it was necessary to pare away only the tongue of the addition that overlapped the original panel and the 1 mm lip (Fig. 6c). Then, when the addition was rocked gently, the brittle hide glue fractured neatly along the joint without disturbing the original panel.

Removal of the Washington Additions

Close examination of the Washington panel seemed to indicate that the abrasion around the edges of the fragments had been caused largely by an attempt to level uneven surfaces *after* the fragments had been glued in place (Fig. 3). Again, the initial idea here was to separate the fragments and reposition them while causing as small an alteration to the existing structure as possible.

The cradle, applied by Stephen Pichetto in 1944,² was typical of the method he almost invariably employed (Figs. 7, 8). He thinned the panel to approximately 5 mm and then laminated it to a mahogany panel of 1 cm thickness oriented in the same grain direction. He then “neatened” the ragged edge of the original poplar panel by the addition of a very thin mahogany band around the perimeter to match the laminated layer (Figs. 8, 9). A cradle was then attached; it consisted of mahogany members oriented in the same grain direction as the panel, with maple crosspieces.

The plan was to dismantle only the section of cradle behind the fragments and then to attach a platform (extending from the two wide lobes on the left and right of the cradle) on which to position the fragments and reconstruct the lunette (Fig. 7).

Two crosspieces at the lower edge were removed, and the mahogany cradle members were sawn through and pared away. The joint line was then marked precisely on the reverse and cut about halfway through the mahogany laminate. The saw cut was made perpendicular to the picture plane, and some additional mahogany was then further pared away on the fragment side to form a V-shaped opening, which enabled a better view of the bottom of the cut (Fig. 10). By repetition of this process, sawing and carving slowly advanced the cut without the risk of cutting into the original poplar.

Figure 7

Reverse of the Washington panel prior to intervention.

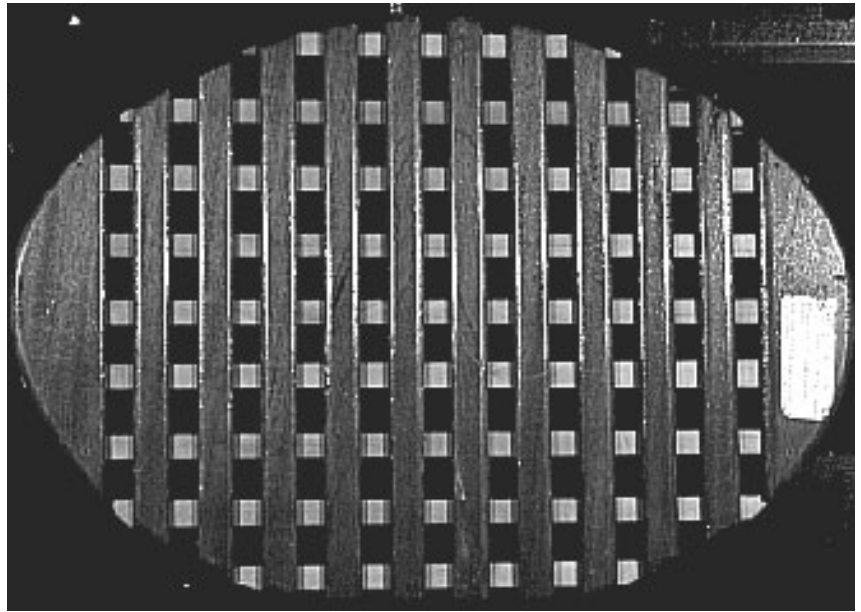
*Figure 8*

Side of the Washington panel. The cradle is approximately 2 cm thick, followed by a mahogany backing 1 cm thick and finally by the original panel, approximately 5 mm thick.

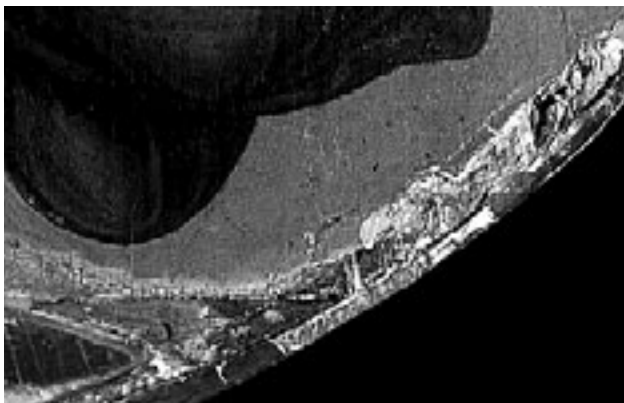
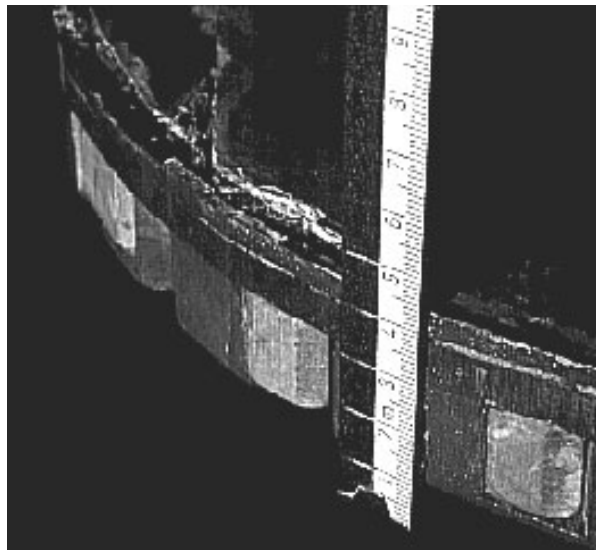
*Figure 9*

Edge of the Washington panel after removal of fill material. The thin mahogany strip can be seen around the perimeter.

*Figure 10*

Carving into the mahogany laminate of the Washington panel, in order to read the depth of the saw cut.



Figure 11, above
Separation of the fragments of the Washington panel.

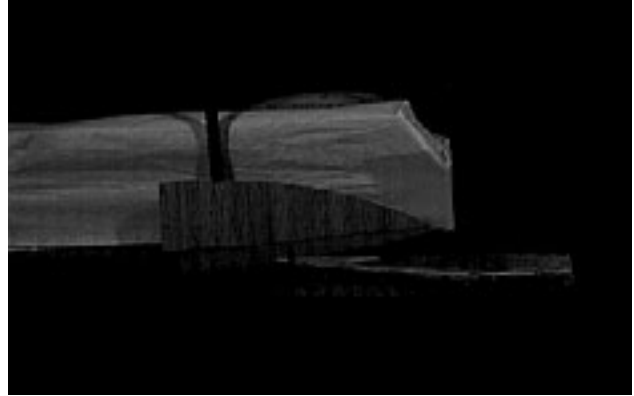

Figure 12, above right
Fragments after removal of the bulk of the mahogany from the Washington panel with the band saw. The 1.5 mm thickness of mahogany can be seen attached to the blue fragment in the foreground.

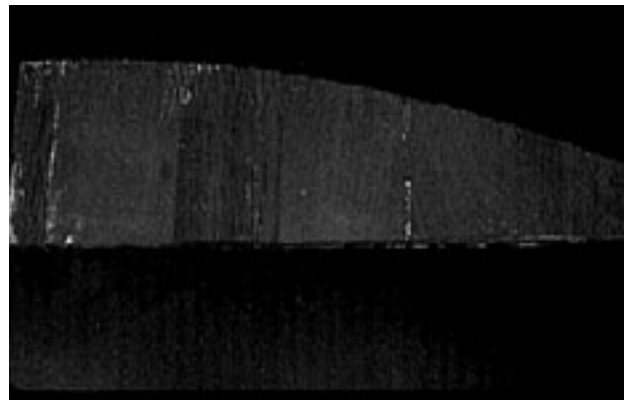

Figure 13, right
Alternating bands of mahogany and poplar between the original panel and the mahogany backing of the Washington panel.

Once the original poplar panel could be seen at the bottom of the cut, the panel was turned over, and the mahogany edging strip was cut in correspondence with the saw cut. Since the grain direction of the panel ran opposite to the fragments, as was the case with the addition to the Metropolitan panel, the hide glue bond was tenuous. Gentle rocking pressure was enough to fracture the glue easily and separate the fragments (Fig. 11). The bulk of the mahogany remaining on the fragments was then removed with a band saw, leaving approximately 1.5 mm attached to the poplar (Fig. 12). The band saw was used because it exerted far less downward pressure on the paint film than the amount that would have been required to carve away the remainder of the mahogany. The operation took only a few seconds and, with a well-tuned band saw, required nearly no pressure and little risk.

The next step was to pare away the remaining mahogany from the fragments. During this step, a layer less than 1 mm thick of alternating bands of mahogany and poplar was encountered (Fig. 13); it formed a continuous layer between the original panel and the mahogany laminate in the entire Washington picture. (It was oriented in the grain direction and consequently ran cross-grain only under the small fragments.) The purpose of this layer is not understood at present, but it may have had something to do with adhesive compatibility. The poplar would perhaps adhere better or react similarly to the poplar panel, and the converse would be true for the mahogany. These alternating bands were literally paper-thin and could easily have gone undetected. The existence of these bands is interesting, given the fact that, in contrast to most cradles, those applied by Stephen Pichetto usually function well, even after fifty years. This small detail may contribute in some way to their success.

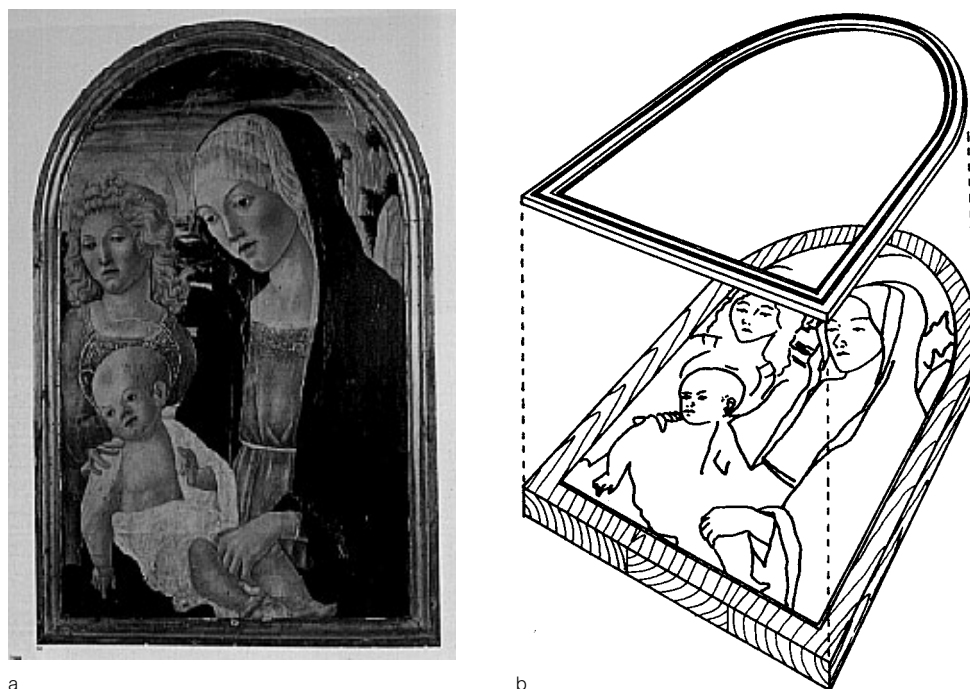

Figure 14a, b

Francesco di Giorgio Martini, *Madonna and Child with Angel*, 1474. Tempera on panel, 74.5 × 49 cm. Pinacoteca, Siena (cat. 288). The panel and frame are integral to this work (a). Gesso was applied continuously over the frame and panel before gilding and painting. The exploded view (b) of the engaged framing elements shows that if they were removed, the uncoated portion of the panel would be visible. The unpainted tips of the small fragments in the Washington panel indicate that this was the original method of construction.

During the removal of this layer, another detail came to light that substantially altered the plan for completing the lunette. After removal of the alternating bands on the small fragments, it was found that the original poplar extended beyond the painted areas at the pointed ends of the fragments (Figs. 3, 9). It had been previously assumed that these areas had been filled with additional scraps of old poplar, but, instead, the poplar was continuous.

Since the curve traced by the edge of the painted surfaces of the fragments contained the lip or barb characteristic of the perimeter of painted panels with engaged frames, it was deduced that the tips of the fragments had not been painted originally and were instead part of the panel onto which the original framing elements had been affixed before gessoing, as was common in the late quattrocento (Fig. 14a, b). A preliminary arrangement of all four fragments based on the convergence of lines in various design elements showed that the unpainted tips of the small fragments extended beyond the painted surface of the main fragment (Fig. 15). Obviously, they could not be trimmed off because they were the only evidence clarifying the original structure of the panel; instead, wood was added around the perimeter to encompass these tips. This addition would not be visible ultimately, because it would eventually be cropped by the frame, but it was considered necessary, nonetheless, to protect the fragments better while more clearly indicating their function. To attach the addition, however, further alterations would have to be made to the cradle.

Since the bottom of the cradle was already altered, and the author was also planning to alter the lobes at the left and right, altering the upper curve as well would mean that the only undisturbed section of cradle would be a small area in the center. In light of this new information, retaining the cradle became a less logical alternative. After consultation with the conservation department of the National Gallery, it was decided to remove the entire cradle but leave the mahogany laminate attached to the original poplar panel. Although this alternative appeared unnecessary

Figure 15

Preliminary arrangement of all fragments.



at the beginning of the intervention, it became more obviously logical and efficient after the discovery of the unpainted tips. All additions would be built onto the mahogany without disturbance to the poplar panel. After the cradle was removed and the back scraped clean, a track was routed to half the thickness of the mahogany, and new mahogany pieces were fitted to extend that plane to accommodate the fragments, including their protruding tips (Figs. 16, 17). After the exact placement of the fragments was decided, the areas that were completely missing would need to be built up from the mahogany to the level of the gesso preparation (see Figs. 8, 9). Very old poplar brought from Italy was used for this purpose in order to maintain a consistent structure (Fig. 18). After the poplar collar was glued to the mahogany with a polyvinyl acetate (PVA) emulsion (Fig. 19), the fragments were set into the cutouts in the collar and precisely aligned with the surface of the main part of the panel, both along and across the grain. Rabbit-skin glue thickened with calcium carbonate was used as an adhesive to fill any gaps caused by adjusting for surface level. Other adhesives, such as Ciba-Geigy Araldite 1253 carvable paste, have excellent gap-filling properties as well as much longer curing times; however, the traditional

Figure 16, below

Fitting of the mahogany extensions for the Washington panel.

Figure 17, below right

Washington panel after the completion of the mahogany additions.

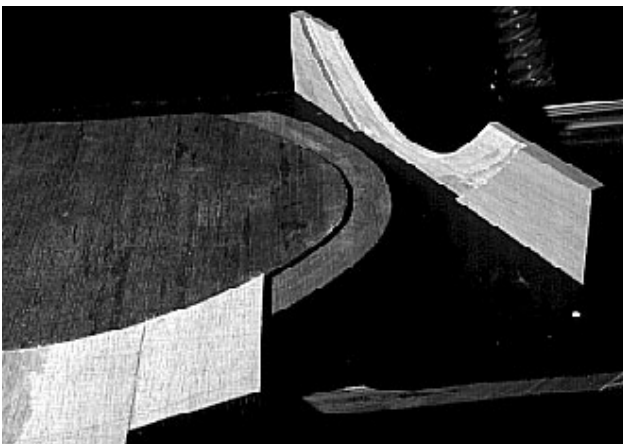

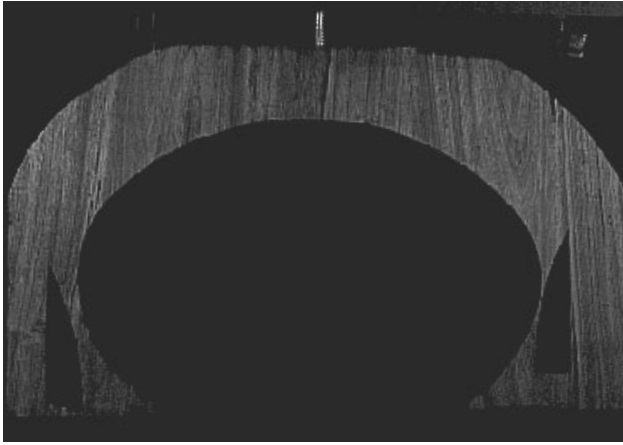

Figure 18, above
Poplar collar used to build up the missing areas to the surface level of the original poplar panel of the Washington panel.



Figure 19, above right
Gluing of the collar to the mahogany backing for the Washington panel.

organic adhesive was selected because it is more easily reversible.³ The disadvantage of its quick setting time was minimized by repeating the clamping procedure dry several times until the same results could be achieved consistently, accurately, and quickly. The perimeter was then drawn and trimmed on the band saw (Fig. 20).

Two crosspieces of the Florentine type described elsewhere (see Rothe and Marussich, "Florentine Structural Stabilization Techniques," herein) were then fabricated and applied (Fig. 21). The contact faces of the crosspieces themselves, as well as the small retaining pegs that hold the crosspieces, are machined to an angle of 22.5° . The two rows of pegs create a sort of dovetail track within which the crosspiece can slide, allowing for any lateral expansion and contraction of the panel. The trapezoidal shape of the crosspiece also permits convex flexing of the panel, and the small contact faces of the pegs minimize friction against the crosspiece, making it virtually impossible for it to bind. The pegs were attached to the panel with Ciba-Geigy Araldite 1253 carvable paste, the gap-filling properties of which make it possible to set the contact between the peg face and crosspiece precisely, while the resin adequately compensates for any irregularity between the peg bottom and the panel. If inordinate pressure were eventually to accumulate in the panel from warpage, the small pegs would tend to delaminate rather than cause the panel to split.

Figure 20, below
Band saw being used to trim the perimeter of the Washington panel.

Figure 21, below right
Reverse of the Washington panel after application of the crosspieces.

This type of secondary support (later abandoned because of developments described on the following pages) was applied only to a panel that had previously been thinned considerably for warp reversal or for the application of a cradle. It would generally not be used for a panel

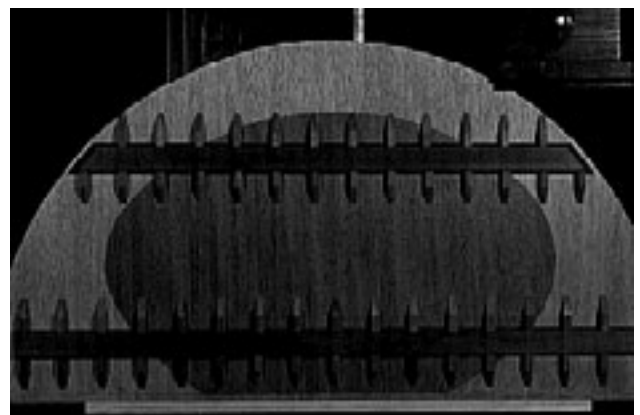



Figure 22, above
Washington panel after application of gesso.



Figure 23, above right
Washington panel after inpainting by Sarah Fisher.

that had retained its original surface, because the support was considered too great an aesthetic intrusion.

The missing areas were then gessoed and inpainted by Sarah Fisher, head of paintings conservation at the National Gallery (Figs. 22, 23). Both pictures were then butted together without glue in a single frame made for the exhibition (Figs. 24, 25).

This arrangement proved successful enough to prompt the two institutions to agree to the permanent rejoining of the panels subsequent to the exhibition and joint ownership thereafter.

Permanent Rejoining

Among the problems presented by the permanent rejoining, the most difficult to resolve was the discrepancy between the beautiful, uniform surface of the Washington panel and that of the Metropolitan panel, which displayed such problems as several open splits, warps, and planar distortions, most of which were related to the cradle (see Fig. 5). Although the condition of the Metropolitan panel was less than ideal, it was nonetheless stable, given the satisfactory environmental conditions within the museum. While the aesthetic improvement of the surface had always been an attractive idea, it was felt that the subtle aesthetic gain did not justify the extensive structural treatment to which the panel would have to be subjected. Now, however, in light of the permanent rejoining, the relationship between the upper and lower surfaces seemed important enough to justify the intervention.

Figure 24, right
The two pictures abutted together without glue in a single frame made for the 1988 exhibition *Painting in Renaissance Siena: 1420–1500*.

Figure 25, far right
Reverse of the panels during the exhibition. The Washington panel (above) is wider than the Metropolitan panel because of additions made to the perimeter.

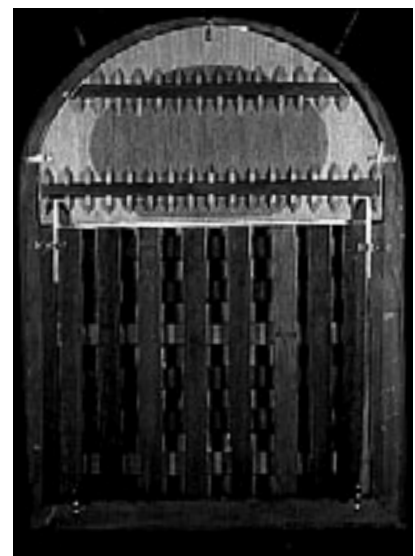

The cradle (Fig. 4) not only limited access to the splits but also impeded the improvement of the surface alignment and adjustment of the overall curvature of the panel. These problems were compounded by a thick layer of wax that had been poured hot over the entire cradle and panel, probably in the 1950s.

The wax and cradle were removed. The splits were repaired using the Florentine wedge method, which consists of the following procedure: First, V-shaped tracks are cut as narrowly as possible along the splits, and wedge-shaped pieces of wood are then fitted with extreme precision and glued into the tracks. The wood used is of the same type as the panel and as close in age as possible. An attempt is made to match the grain direction, cut, and even the degree of worm tunneling, so that the repair does not exert a greater or lesser structural force within the panel. (For examples of this technique, see Rothe and Marussich, "Florentine Structural Stabilization Techniques," herein.)

This controversial method was developed for a number of reasons. Of course, whenever possible, simple splits that fit together well should merely be reglued; however, in many cases they are too tight for glue to be introduced to the full depth. As a result, they continue to move near the paint surface, causing new fills to reopen and splits to continue to lengthen. In the case of older splits, some are considerably more open on one end than on the other and cannot be closed without excessive pressure; in such cases, filling them with relatively large amounts of adhesive would become necessary. Others, because they have warped differently on both sides of the split, have complicated surface leveling problems and other planar distortions. And others, because of repeated treatments in the past, are filled with wax, dirt, varnish, gesso, and organic and inorganic adhesive residues that impede accurate regluing.

By cutting a narrow, V-shaped track, one gains full access to the entire depth of the split while removing any extraneous material and exposing pristine gluing surfaces for a better adhesive bond. Surface curvature and level can be precisely adjusted in very short segments—even one wedge at a time—ensuring highly controlled results. The precision of the fit can reduce the amount of adhesive necessary by several hundred percent. By the fitting of short wedges, the faces of each segment of the V-shaped track can be readily prepared perfectly flat, and irregular splits can be followed with greater accuracy. Moreover, if the wood of the wedge were to have any tendency to move differently from the panel, its strength would be minimized by the interruption of the cell chains due to the short lengths of the wedges: it is unlikely that individual wedges could do more than simply follow the movements of the panel.

The controversial aspect of this method is, of course, the removal of original material. Two factors come into play in this regard. One is the undeniable primacy of the painted surface and its ability to function or convey its particular pictorial meaning. The second is the contribution the panel makes toward the overall aesthetic of the work of art as an object, including the practical information that can be gleaned from tool marks, dowel holes, edges, metal attachments, and so forth; this evidence can shed light, for example, on fabrication techniques, placement within an altarpiece, and original collocation, and it must be scrupulously respected.

These two factors must be considered together in the planning of the extent of any structural intervention. The situation is substantially different, however, when a panel has been thinned and cradled. Any



Figure 26
The Washington panel (left) and the Metropolitan panel, aligned in position for permanent rejoining.



Figure 27
Planing of the track between the two panels. Note the gesso filling added into the slightly irregular joint at the center.

aesthetic aspect or technical information contributed by the original wood surface has already been eliminated. Therefore, the decision to remove a small amount of material that had never been visible from the exterior, in a process that could greatly facilitate the aesthetic improvement of the painted surface as well as the future stability of the panel, can be justified. If, to take a hypothetical example, a panel were to lose both its back surface as well as its painted surface, would the core material retain any value as a work of art or even as a historical document?

It should be stressed that the removal of original material—even that which was never visible on the surface—remains a radical decision and should not be undertaken as a matter of course. The fitting of these wedges is a dangerous operation and, unless it is very precisely executed, offers little advantage over simpler methods of regluing. When executed precisely, however, it produces a repair of exceptional stability and durability while allowing uniform, uninterrupted expansion and contraction across the panel. It also permits extremely accurate surface-level and curvature adjustments with minimal aesthetic compromise.

An interesting solution for Botticelli's *Man with a Medallion* in the Uffizi Gallery was recently presented by Ezio Buzzegoli and Marco Marchi of the Soprintendenza per i Beni Artistici e Storici di Firenze e Pistoia (Buzzegoli, Marchi, and Scudieri 1993). In this example, the panel retains its original surface, but a split traveling upward from the bottom was causing the *pastiglia* medallion held by the sitter in the picture to fracture. With a scalpel, conservators removed the "skin" of wood around the split in one continuous piece, fitted the split with wedges, and reattached the skin so as not to disturb the overall aesthetic.

Attachment of the two panels

After all the splits in the Metropolitan panel were fitted with wedges, thereby improving the surface leveling and overall curvature, the two panels were then aligned (Fig. 26). The top of the Metropolitan panel already had a routed track from the attachment of the old addition. It was decided to rout a similar track into the mahogany of the Washington panel without cutting into the original poplar (Fig. 27). Short poplar blocks were then made to bridge the two panels. The blocks were fitted and glued a few at a time, beginning at the center, so the paint surface could be carefully leveled as each piece was glued in place (Fig. 28). Before each piece was glued, the end-grain joint between the panels was filled from the back with gesso to produce a tighter fit. Each fixed piece provided a point of leverage from which to level the next piece—and so on, until the track was completed. Rabbit-skin glue thickened with calcium carbonate was used again as an adhesive.

The sides of the Washington panel were wider than those of the Metropolitan panel because of the additions that were made around its perimeter (Figs. 25, 29). No additions had been made to the Metropolitan panel because, although the same amount of wood was missing around its perimeter, as long as the panel existed as a separate entity, there was no pressing need to reconstruct it. Besides, it would eventually only be cropped by the frame. Other evidence (the raised lip or barb at the edges of the painted surface) made it clear what was missing, and this was considered sufficient. The decision to add the missing wood in the



Figure 28
Gluing of the blocks.

Washington panel was motivated primarily by the need to find a solution that would physically protect the tips of the fragments without falsifying the aesthetic of the object. Now that the panels were permanently rejoined, it made sense to add the missing strips to the sides of the Metropolitan panel as well, in order to simplify the perimeter, reflect the original fabrication method, and strengthen the entire construction.

It was decided not to continue the addition across the bottom edge of the picture because it was considered unnecessary. Not only would the end-grain attachment present its own problems, it would not in itself resolve any other problem.

The back surface of the Metropolitan portion of the panel had been scraped in order to remove all wax and glue residues, and it was now judged to be potentially highly reactive to humidity fluctuations. A coat of Acryloid B72 was applied; this product is not totally impermeable but merely slows down the moisture exchange rates.

Two crosspieces similar to those already applied to the Washington portion were fabricated and attached (Fig. 30). The coat of Acryloid B72 applied as a moisture barrier would also facilitate the release of the retaining pegs of the crosspiece system in the event that too much stress were to accumulate at some point in the future.

The two institutions formally agreed to alternate custody of the newly rejoined panel every five years (beginning in Washington, since it had first been exhibited briefly at the Metropolitan for the exhibition of Sieneese Renaissance painting). The interval was considered reasonable given the proximity of the two museums. A custom-designed crate equipped with cushioning for shock as well as vibration absorption and thermal insulation was then provided. Whenever the painting travels, it will be accompanied by museum couriers and transported via truck with air-ride suspension and climate control, for better control of cargo handling and climatic variables than if the painting were transported by air.

One final alteration was made to the secondary support upon its return to New York in October 1994. Although the four Florentine-type

Figure 29, right
Upper right portion of the joined panels.

Figure 30, far right
Reverse of the joined panels after application of the crosspieces on the Metropolitan panel. Note the strips newly added to the sides of the panel, as well as the continuous narrow strip of poplar that forms a bridge to the Washington portion, greatly increasing the stability of the joint.

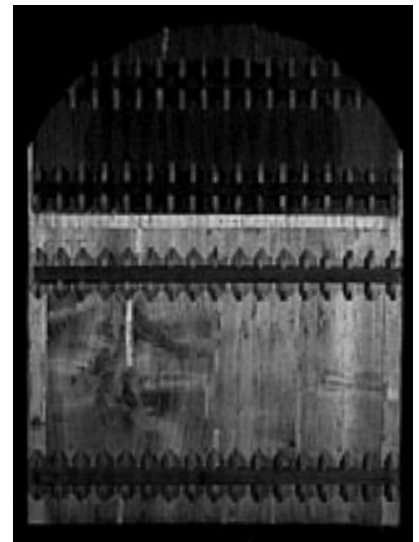

crosspieces described above functioned adequately, they were substituted with the type of secondary support first published by *Ciro Castelli and Marco Ciatti* (1989). This system consists of a strainer that follows the perimeter of the panel exactly and, in this case, has two fixed crosspieces and one fixed vertical member. The strainer is simply held in place by springs, fixed to the strainer on one end and attached on the other end to small blocks of wood oriented in the grain direction; these blocks are, in turn, spot-glued to the back of the panel (Figs. 31, 32). The spring is not fixed rigidly to the small block but instead slides freely within a predrilled hole, allowing for expansion and contraction of the panel, as well as convex flexing or even straightening. The bottom edge of the strainer has a small lip that protrudes to accommodate the thickness of the panel and prevents the weight of the panel from fatiguing the springs over time.

This system offers several advantages over the traditional Florentine-type crosspieces previously employed, especially in the case of very thin panels. The strainer protects the fragile perimeter and offers greater resistance to torquing and better overall stability, while more closely approximating the original thickness of the panel and making it easier and safer to handle. The system also reduces the surface area adhered to the panel while distributing the support more regularly and without adding any weight to be supported by the panel. It also allows more localized, independent movement of any specific area of the panels, and the spring tension can be calibrated to take into account the species of wood, thickness, cut, degree of worm infestation, and past treatments.⁴

Finally, if the screws that attach the springs to the strainer are recessed, a lid or cover can be fitted over the back. Not only does this cover offer protection, it also creates a microenvironment that can buffer humidity fluctuations. Furthermore, silica gel tiles can be attached to the inside of the lid between the various crosspieces. It should be noted, however, that this solution makes no attempt to function as a climate-controlled vitrine. There is no glass in front of the picture, and the sides are not sealed. Prolonged exposure to low humidity will produce the same effects as the absence of silica gel. However, the semicontrolled environment can constitute a substantial buffer to humidity fluctuations, even eliminating movements of the panel that would be caused by daily humid-

Figure 31, right

Reverse of the panel with the spring tension strainer in place.

Figure 32, far right

Spring mechanism shown in place.

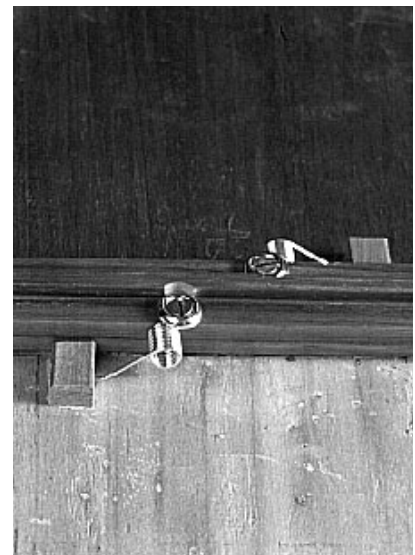

Figure 33

Metropolitan and Washington panels after permanent rejoining.



ity oscillations in the range of 10–15%. Essentially, the panel reacts more or less as though it were unthinned.

Silica gel tiles were not added to the Francesco di Giorgio Martini work; however, had the panel been more quickly reactive or had the environmental conditions within the two institutions been less stable, they would have been a likely option (and they remain an option in the future).

Whenever this type of secondary support is used, care should be taken to secure the object in its frame by means of some kind of flexible clip. If it were fixed rigidly and the panel were to increase its convex warp, the necessary movement would otherwise be blocked by the frame rabbet.

Although the various phases of treatment of these panels offer no technical innovations, the project as a whole demonstrates the degree to which overall context plays a determining role in assessing the appropriateness of any proposed treatment. In this instance, solutions were repeatedly modified throughout the treatment process to accommodate new physical and contextual information that came to light during the course of the intervention (Fig. 33).

Acknowledgments

The author would like to thank Keith Christiansen, Jane Wrightsman Curator for Italian Paintings at the Metropolitan Museum of Art, New York, for his inspired and enthusiastic collaboration; Tom Wilmering, head of furniture conservation in the Objects Conservation Department of the Metropolitan Museum, and Ciro Castelli of the Opificio delle Pietre Dure, Florence, for their valuable technical advice; and Sarah Fisher, head of paintings conservation, National Gallery, Washington, D.C., and Laurent Sozzani, then an intern at the Metropolitan Museum, for their dedicated work on the painting surfaces.

Notes

- 1 A photograph taken in 1897 in the files of the Metropolitan Museum already records the addition to the top of the Metropolitan panel.
- 2 Stephen Pichetto was trustee and/or curator of the Kress Collection from 1932 until his death in 1949. He maintained a large conservation studio with several employees, and many important pictures purchased in America during this period were treated in his studio. A man named Angelo Fatta was apparently responsible for the thinning and cradling of panels under Pichetto's direction.
- 3 In conservation practice, *reversible* is often synonymous with *soluble*. Obviously, the Ciba-Geigy Araldite is not reversible in this sense. In many cases the solubility of an adhesive would not be physically possible or even desirable. For instance, attempting to dissolve a water-soluble adhesive sandwiched between wooden elements beneath a gesso ground, all of which are hygroscopic, would have disastrous results. Often, as in the present example, mechanical reversal of an insoluble adhesive would be preferable to any attempt at dissolving an adhesive layer. Since rabbit-skin glue becomes brittle, it is possible to carve down to the glue line and scrape away the glue without further damage to the original panel.
- 4 These variables would be very difficult, if not impossible, to quantify. Consequently, spring tension must be set according to an empirical understanding based on knowledge accumulated from the handling and flexing of similar panels.

Materials and Suppliers

Acryloid B72, Rohm and Haas Co., Independence Mall Street, Philadelphia, PA 19105.

Araldite 1253 carvable paste, Ciba-Geigy Corporation, 4917 Dawn Avenue, East Lansing, MI 48823.

References

- Buzzegoli, Ezio, Marco Marchi, and Magnolia Scudieri
- 1993 L'uomo con la Medaglia del Botticelli e il 'Morgante Nano' del Bronzino. *OPD Restauro* 5:23–27, 67–68.
- Castelli, Ciro, and Marco Ciatti
- 1989 Proposta di intervento su particolari supporti lignei. *OPD Restauro* 1:108–11.
- Zeri, Federico
- 1964 Un intervento su Francesco di Giorgio Martini. *Bollettino d'arte* (1):41–44.

The Cradling of a Relief of the Annunciation Attributed to Martin Schaffner

Frédéric J. M. Lebas

THIS RELIEF, dated to around 1515 and part of a retable of unknown provenance in Ulm, has been attributed to Martin Schaffner (1477/78–1546/49), an artist active in Ulm and the duchy of Swabia (Fig. 1). Its composition, reminiscent of an engraving by Martin Schongauer (ca. 1430–91), could be a model for other Swabian reliefs of the Annunciation of the same period (Sprinz 1925).

The relief, on limewood, is 104.8 cm high and 118.1 cm wide. Mary is represented in front of a tent-shaped baldachin kneeling at her prayer stand; she is holding her cloak with her right hand, and her left is resting on her open prayer book. Mary's eyes are cast down pensively. Gabriel has appeared on her left; he is holding a scepter in his left hand, which also lifts the curtain to open the baldachin. In the center of the background is a vase with lilies (Eckhardt 1982).

Figure 1
Martin Schaffner (attrib.), *Annunciation*,
ca. 1515, before restoration. Relief on panel,
104.8 × 118.1 cm. Ulm, Germany.



Figure 2
Martin Schaffner (attrib.), *Annunciation*. Back
of the relief before restoration.



The relief is composed of four vertical slab-cut boards, reversed and glued together (Marette 1961). It was reinforced with seven 3 cm thick limewood boards (five uprights and two crosspieces), apparently glued and held together by forty screws (Fig. 2). For hanging, two attachments, each affixed by three screws, were added to the upper crosspiece; the frame was held in place by four long nails inserted into the sides of the cradle. Two 3 mm wide cracks had run up the whole length of the panel, while two shorter ones, each about 50 cm long, started upward from the bottom of the panel. The wood has been heavily eaten by *Anobium punctatum* worms. A prior restoration is indicated by numerous fillings of holes, reconstructions in places with wood filler, and portions of various sizes reworked with limewood. Tunnels left by xylophagous larvae, visible on the surface of the relief, suggest that the panel may once have been painted; the small remaining amount of ground does not allow us to be more definitive. The maximum thickness of the relief is 10 cm. The cradle, with its two crosspieces, created the stresses in the panel that caused the cracking discussed above. Therefore, the cradle had to be removed.

Treatment

The relief was placed facedown over a thick pad of foam; the cavities in the wood were then filled with pieces of the same foam cut to size. The boards were removed one at a time; they were first cut into pieces of various sizes according to the thickness of the relief and the location of the cracks. Each piece was then thinned down with a chisel, and the surface was carefully finished with a scalpel and damp pad, which removed all traces of animal glue. This work uncovered nails and wooden pegs that had been inserted from the front of the panel to maintain the reconstructions. The back of the relief being very uneven and the cradle boards quite flat, the cradle boards had not adhered in all places, and in some areas the glue was 2–3 mm thick between the relief and the cradle—it is easy to imagine the stresses these irregularities caused on the surface of the wood. After cleaning, saw marks became visible on the back, indicating that the

panel had been thinned by sawing (Fig. 3). The relief, now in several pieces, had to be glued together again.

As the relief was not solid enough to support itself in its frame, a new structure had to be built. There were many options. The relief is very irregular: heavy and thick, especially at the left and right margins, and thin in the center for almost the whole height. A light support was required, capable of adapting to the potential movements of the original, including swelling, shrinking, and convex and concave warping. Moreover, the back of the panel is very uneven. After a few weeks, during which the relief was left flat without constraints, a cradle design was selected: it was to be made of small balsa-wood pieces, 10 cm long, 4 cm wide, and 1.5 cm thick, glued in two staggered layers, with the grain direction following that of the relief. The size chosen for the pieces was related to the width, height, and thickness of the relief, as well as to the irregularities of the surface.

The back of the panel was very uneven and had many holes, which needed to be filled in to even out the surface to some extent. Sheets of limewood veneer, with the edges thinned down and the angles and edges rounded, were adhered to the panel with Keimfix and clamped. After several attempts to fill other holes with various glues, these other cavities were filled with sifted limewood sawdust mixed with ethyl cellulose glue in a toluene solution: this produced a fine, soft, and easily worked elastic paste. Next, the back of the panel was coated with a solution of 10% Paraloid B72 in toluene, to isolate the panel from the wax used to attach the cradle, thereby preventing penetration of wax into the panel's wood. This wax is a 50–50 mixture of beeswax and Lascaux 443-95 adhesive wax (pure beeswax would not have been strong enough; the adhesive wax would have been too strong). The wax mixture was heated in a double boiler and brushed on the back of the panel; the mixture was then warmed with an industrial-type heat gun to spread it evenly in a thin layer.

The cradle was started in a vertical line in the center of the panel. The balsa pieces were dipped in the hot wax and arranged side by side as one might build a wall. However, before they were actually glued, they were set into place to see how well they fit. If there was a gap between

Figure 3
Martin Schaffner (attrib.), *Annunciation*. Saw marks on the back of the relief.



Figure 4

Martin Schaffner (attrib.), *Annunciation*. Model showing the construction of the cradle and the new attachment of the frame.

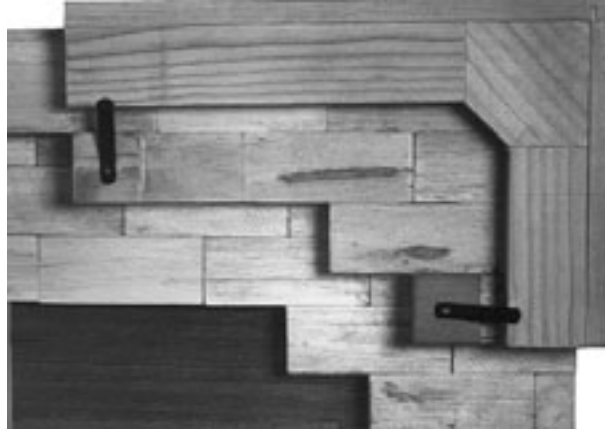

the panel and the balsa, an extra piece of balsa was shaped to fill in the gap; if, on the other hand, there was a protrusion on the panel, the block was shaped or grooved to accommodate the protrusion, allowing the block to fit closely against the relief panel. The blocks were then glued down. Once the first layer was finished, it was leveled by planing. The second layer of balsa was placed in the same direction as the first but was staggered so that the joints were not superimposed (Fig. 4). That layer was also planed down after it was in place. The edges were smoothed all around and the cradle brushed with a solution of 10% Paraloid B72 in toluene, a coating intended to ensure a good finish. The first phase of the treatment was over.

The problem of maintaining the relief in its frame, however, remained. As the frame was made simply of four lateral gilt-edged boards, the question arose of how to attach it to the relief. Four boards were added to the inside of the frame, so that an opening was left in the back. They were glued and pegged; then cleats were glued on the cradle 1 cm from the inside of the frame with pure Lascaux 443-95 wax, and springs were screwed onto the cleats to hold the relief in the frame (Figs. 4, 5).

Figure 5

Martin Schaffner (attrib.), *Annunciation*. Back of the relief after restoration.

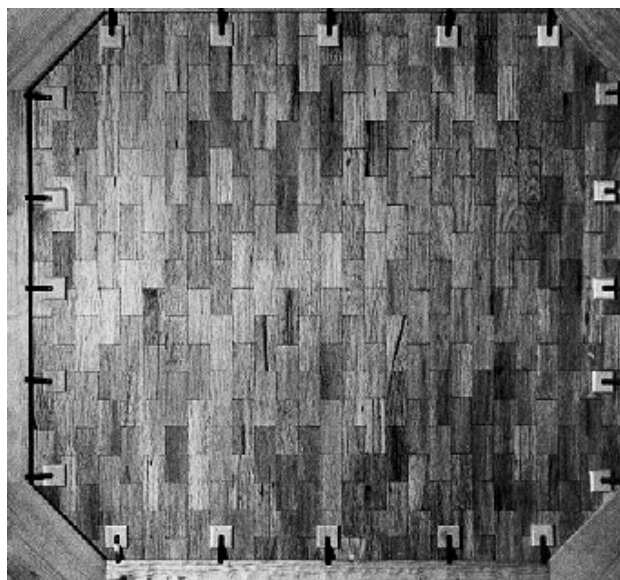

The advantage of this structure is that it allows the relief to move freely in all directions within the frame. The attachments for hanging were affixed to the back of the frame and not, as previously, on the cradling. Finally, the surface of the relief was cleaned, and the old repairs, putty fillings, and gaps were reintegrated with watercolor.

The restoration was completed on 5 May 1982 and has been inspected regularly since then. It remains in good condition.

Materials and Suppliers

Ethyl cellulose glue (N 50), Hercules Inc., 910 Market Street, Wilmington, DE 19899.

Keimfix, Keim Leim AG. and Co., Mechternstr. 57, 5000 Cologne 30, Germany.

Lascaux 443-95 adhesive wax, A. K. Diethelm AG, Ch 8306 Brüttsellen, Germany.

Paraloid B72 (in U.S., Acryloid B72), Rohn and Haas Co., Independence Mall West, Philadelphia, PA 19105.

References

- Eckhardt, Wolfgang
1982 Erwerbungen für die europäischen Sammlungen in den Jahren 1980–81. *Jahrbuch des Museums für Kunst und Gewerbe Hamburg* 1:144–46.
- Marette, J.
1961 *Connaissance des primitifs par l'étude du bois*. Paris: Picard.
- Sprinz, Heiner
1925 Die Bildwerke der Fürstlichen Hohenzollernschen Sammlung Sigmaringen. *OJS* 77:23.

Backings of Painted Panels

Reinforcement and Constraint

Jean-Albert Glatigny

BACKING PANEL PAINTINGS with balsa-wood blocks glued with wax-resin is an uncommon technique rarely used by the Institut Royal du Patrimoine Artistique, Brussels (IRPA). In ten years, it has been applied to only about ten paintings. These were oil paintings on oak panels from the sixteenth or seventeenth century that needed to be reinforced, maintained, or constrained for stability or display. At IRPA, reflections regarding this type of treatment have been based on the published descriptions of several authors (Buck 1970; Spurlock 1978; Beardsley 1978; vom Imhoff 1978).

Since at IRPA reversibility is considered to be an absolute requirement for an adhesive, we opted for damar wax-resin rather than a tridimensional resin. Subsequently, collaborative work with our French colleagues¹ as well as comparative studies made by students (Habarú 1990–91; Mori 1992–93) have enabled us to refine this technique. Each intervention has led to discussion and research aimed at improving the technique and adapting it to the specific problem of each panel.

First, the two types of deterioration of painted panels that we believe justify a balsa backing will be described. The choice of materials and work method will then be explained.

Reinforcement of Thinned Panels

Frequently, panels are found whose original construction has been altered by earlier, well-intentioned restorers. The history of treatments for painting supports has seen many changes in fashion. Some problematic panels underwent the addition of crosspieces, cradling, or even transfer. To perform these so-called restorations, the supports were thinned down or eliminated.

Today these restorations are faulted, first, for radically transforming the structure of the work and, second, for proving ineffective. Moreover, the irremediable loss of technological and historical evidence is very unfortunate. These restorations must now often be reversed to save the lifted and distorted paint layer. Once the additions have been eliminated, we are left with a work whose support is so thinned down that it is no longer able to stand by itself.

The backing of these thinned-down panels with balsa-wood blocks adhered with wax-resin presents a significant advantage—namely, the method is easily thermoreversible. Because it is made up of a multitude of waterproof cells whose pure cellulose walls are difficult to perme-

ate, balsa wood is an inert material that is not subject to distortion over time. Once the panel is backed, it is resistant but not much heavier. The adhesive used, a mixture (by weight) of seven parts beeswax and two parts damar resin, is relatively flexible, and its adhesive strength is moderate. These particular qualities, while they contribute security to the panel, are at the same time the technique's weak point. Paintings treated this way will require special precautions, especially with regard to mechanical shocks and high temperatures.

Constraint and Straightening of Distorted Panels

Panel paintings, which don't have a paint layer on their reverse, are often more or less convex. If the distortions are distributed evenly over the whole of a panel, the viewer will not be troubled. But the presence of a single, limited distortion can be so disturbing as to alter the look of the painting completely. These distortions have internal causes—for example, the wood's nature, density, or method of conversion (the way it has been sawn). They emerge as a result of poor conservation conditions, such as serious fluctuations of relative humidity (RH) and the constraints wrought by framing.

Balsa-wood backing glued with wax-resin has been used to maintain distorted panels after flattening. The method consists of increasing the water content of the whole panel in an air-conditioned chamber and locally applying damp compresses over extremely distorted areas. The aim is to reach a point of balance at which the boards recover their inherent flatness. Once this condition is achieved, the backing is applied to the whole back of the panel. Balsa-wood backing with wax-resin acts as a mechanically uniform maintenance device; moreover, it slows down humidity exchanges. It forces the panel to remain flat during the drying period, a process that completes the treatment and subjects the wood cells to plastic distortion. The return to an RH of about 60% takes place gradually, in a matter of two to three months.

Balsa-wood backing, in this case, fulfills a provisional function. It can be removed as soon as a panel is stabilized in an environment where the RH is controlled. To date, however, as a precaution, such backings have been left on. Balsa and wax-resin act as barriers against humidity.

The advantage of this technique lies in the fact that if the constraint on the drying panel is higher than the adhesive strength of the wax-resin, the backing will come unglued. In such a case the panel will reassume some curvature and will not be threatened with splitting.

Among the treated paintings, three thin (less than 2 cm) oak panels that were formerly distorted are currently backed. This way, while keeping them at a stable RH, we have succeeded in keeping them flat. If the RH were not controlled, the backing would retard the emergence of distortions, but it would not prevent them. The treatment can be applied again if necessary.

Materials

Balsa wood is commonly used in restoration. It is valued for its extremely low shrinkage, its light weight, and its waterproof qualities. The kind used at IRPA comes from Ecuador, and its weight varies from 80 kg m^{-3} to 290 kg m^{-3} . The elements used were all of the same density, 170 kg m^{-3} .

After experimenting with rectangular, square, and hexagonal blocks, in radial and transverse conversion, we opted for 8 cm squares that

were 1 cm thick. The sawing was done in a transverse direction on end-grain wood in order to obtain elements that were as rigid and as easy to work with as possible.

The adhesive is a mixture of seven parts beeswax and two parts damar resin. This adhesive is one that has been used for fifty years by IRPA for certain relinings of painted canvases and for consolidations of paint layers as well. To make the adhesive, raw beeswax is obtained from a beekeeper. It is then washed in boiling water and filtered. This weak adhesive, solid at room temperature and liquid at 60 °C, is stable and flexible, and it can be easily dissolved or reactivated. It is also a good barrier against humidity. It impregnates only the surface of the wood. The reverse of a panel is traditionally sized with rabbit-skin glue at the time of manufacture. This method of insulation, which prevents penetration of the wax, is an option to consider before backing.

Method

Before a panel painting is backed, the adhesion of the paint layer is examined. A facing is applied to the painted surface, the joints and splits of the support are glued, and the lacunae in the wood are filled.

The painting and the balsa blocks are then brought to the same RH level. With a brush and spatula, a layer of warm wax-resin is applied over the entire reverse of the panel, in order to level the irregularities in the wood surface. The wax-resin mixture shrinks as it cools. To control the extent of shrinkage, it is applied in thin, successive coats. The balsa blocks are immersed for a few seconds in the melted adhesive, positioned on the cooled layer of wax-resin on the panel's reverse, and held in place until the wax cools.

The joints between the blocks are aligned diagonally with regard to the grain of the boards that form the panels. Two levels of blocks are glued in this way, the second level being staggered so that the joints are not superimposed. Experience has shown that the joints are the weak point in the handling of panels, and therefore, that a rigid support is desirable. The most rigid support is achieved with balsa blocks sawn in a transverse direction, then placed in two staggered layers, diagonally with regard to the panel's grain.

A sheet of very thin, long-fiber paper (12 g m^{-2}), such as bamboo-fiber paper, is next glued with wax-resin to the backing. After gluing, this paper is transparent. It allows for the control of the possible opening of the joints, and it holds the blocks in place in case of significant ungluing.

The treated panel must be replaced in its frame, which fulfills a dual function: it distributes strains during handling, and it supports the painting when it is hung.

Straightening of a Distorted Panel

A balsa backing was carried out in the conservation-restoration workshop at La Cambre school, Brussels, where the author teaches. Paul Duquenois, a fifth-year student of painting restoration, was in charge of this treatment.

The painting, which represents the Adoration of the Magi, is a seventeenth-century oil-on-wood panel attributed to a member of the very productive Francken family of Antwerp. The support consists of three thin (8 mm) oak boards, sawn on the false quarter and held together with pins. The panel measures 71.4×104 cm. The seal of the guild of Antwerp, a castle and hands, is stamped on the reverse.

The panel comes from the museum of the city of Ath, located in a large eighteenth-century house whose rooms are damp and barely heated in winter. There is no RH-control system. The harsh climatic conditions had caused serious damage to the support. The joints of the panel, blocked in its frame, had come apart, and several cracks had appeared (Fig. 1). The boards presented a severely convex profile, in addition to a spiral distortion. Tunnels of xylophagous insects had caused the wood to become more reactive to variations in RH.

Except for an old restoration consisting of glued strips of linen over the open joints, the support had never been altered. The paint layer, however, was coated with numerous overpaintings. To mask irregularities in the support, the joints and crack areas had been broadly filled in and retouched.

The distortions were disturbing to the viewer and made it impossible to frame and display the work. Therefore, a decision was made to straighten it with a backing while leaving the Antwerp seal visible. The treatment of the support consisted first of eliminating the linen reinforcements, then consolidating the worm-eaten wood with a solution of 10% Paraloid B72 in paraxylene, and finally of gluing the splits and joints (Fig. 2). All the cavities were filled with oak sawdust sifted to less than 0.25 mm in a 25% polyvinyl acetate and water emulsion. Subsequently the paint layer was protected by a facing of silk paper glued with beeswax, and the panel was placed in a microclimate box, where the humidity was

Figure 1

Francken family (attrib.), *Adoration of the Magi*, seventeenth century. Oil on panel, 71.4 × 104 cm. Musée Atois, Ath, Belgium. The condition of the painting before conservation, with splits and cracks, is shown.



Figure 2

Francken family (attrib.), *Adoration of the Magi*. The panel is shown after the gluing of the splits and joints, and before straightening.

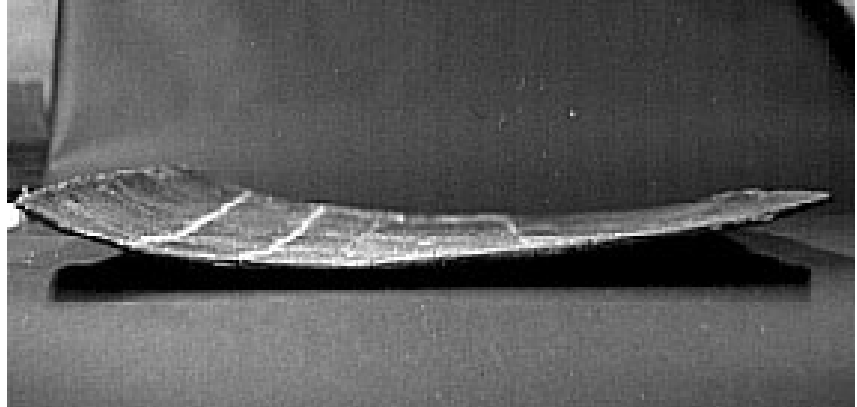

gradually increased. At 75% RH the panel was practically flat; it showed some remaining spiral distortion but had gained good flexibility (Fig. 3). At this juncture it was kept flat in a room where the RH had been stabilized at 75%. A layer of beeswax and damar resin (seven parts to two) was spread over its surface. The wax-resin was applied with a warm brush and smoothed out with a heating spatula. After it cooled, the first 1 cm end-grain layer of balsa wood was placed diagonally across the surface; then the second was placed, overlapping the first (Fig. 4). Finally, the excess wax-resin was wiped off after it had been heated with warm air, and bamboo-fiber paper was glued with the same adhesive. Oversized balsa blocks were sawn to fit the panel. The Antwerp seal was made visible again when an opening was cut out of the backing (Fig. 5).

The panel was gradually brought back to 50% RH. Once the facing was removed, the painted surface was cleaned and retouched (Fig. 6). The painting was fixed in its frame with springs and returned to the museum in Ath. In the year since, no distortion has been observed. The balsa-wood backing provides the work with good support and excellent protection from that environment's significant fluctuations of RH.

Figure 3

Francken family (attrib.), *Adoration of the Magi*, in a microclimate box. The panel has been considerably straightened.

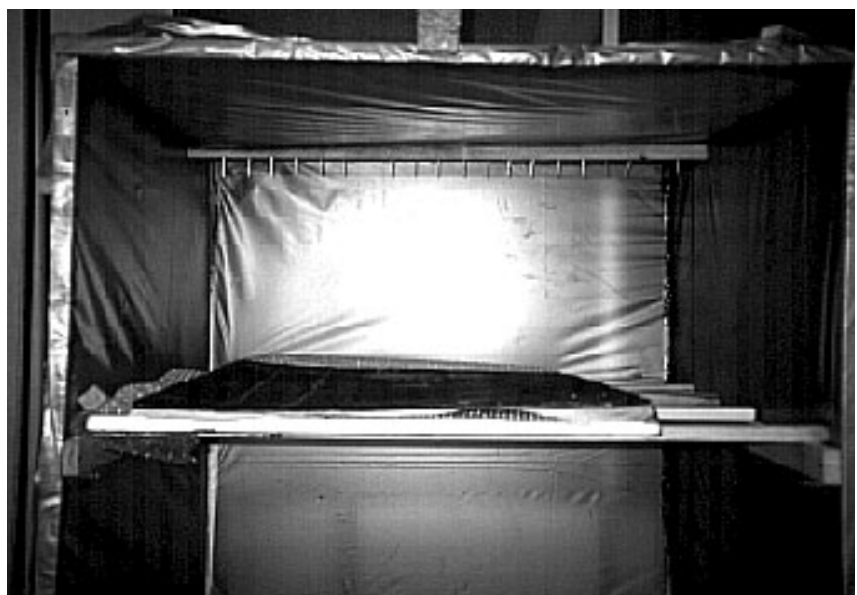



Figure 4
 Francken family (attrib.), *Adoration of the Magi*, reverse. A second layer of balsa blocks is placed on top of the first layer.

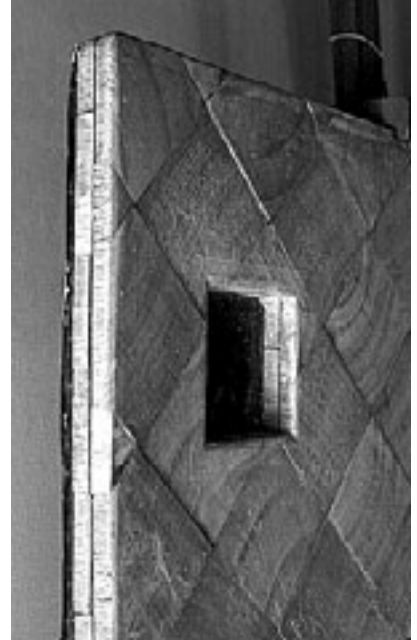

Figure 5
 Francken family (attrib.), *Adoration of the Magi*, reverse, detail. An opening cut in the backing allows viewing of the Antwerp seal.

Figure 6
 Francken family (attrib.), *Adoration of the Magi*, after conservation.



Note

- 1 Patrick Mandron, from the Service de Restauration des Musées Nationaux; Aubert Gérard, from the Centre Régional de Restauration et de Conservation des Oeuvres d'Art; and Jean-Albert Glatigny, from the Institut Royal du Patrimoine Artistique backed two paintings on limewood, using the balsa-wood/wax-resin treatment. These works, which are by Lucas Cranach the Elder, represent Saint Peter and Saint Paul, and they belong to the Louvre Museum.

References

- Beardsley, B. H.**
1978 A flexible balsa back for the stabilization of a Botticelli painting. In *Conservation of Wood in Painting and the Decorative Arts: Preprints of the Contributions to the Oxford Congress, 17–23 September 1978*, ed. N. S. Brommelle, Anne Moncrieff, and Perry Smith. London: International Institute for the Conservation of Historic and Artistic Works.
- Buck, R. D.**
1970 The dimensional stabilization of the wood supports of panel painting. In *Conference on Conservation of Canvas and Panel Paintings, Warsaw, 19–21 October 1970*. N.p.
- Habaru, S.**
1990–91 Le doublage au balsa des peintures sur panneau. Diploma thesis, ENSAV La Cambre, Brussels.
- Mori, N.**
1992–93 Les barrières contre l'humidité. Diploma thesis, ENSAV La Cambre, Brussels.
- Spurlock, D.**
1978 The application of balsa blocks as a stabilizing auxiliary for panel paintings. In *Conservation of Wood in Painting and the Decorative Arts: Preprints of the Contributions to the Oxford Congress, 17–23 September 1978*, ed. N. S. Brommelle, Anne Moncrieff, and Perry Smith. London: International Institute for the Conservation of Historic and Artistic Works.
- vom Imhoff, H. C.**
1978 Reinforcing a thin panel painting. In *Conservation of Wood in Painting and the Decorative Arts: Preprints of the Contributions to the Oxford Congress, 17–23 September 1978*, ed. N. S. Brommelle, Anne Moncrieff, and Perry Smith, 165–68. London: International Institute for the Conservation of Historic and Artistic Works.

A Flexible Unattached Auxiliary Support

Simon Bobak

A LARGE PROPORTION of panel paintings that have been thinned and cradled exhibit damage caused by the cradle or signs of stress from it. Environmental conditions play a large part in this equation. Much can be done by altering the environment to achieve stability, even with the cradle left largely unaltered.

However, many panels are so stressed or damaged by the cradle that it is essential to remove it. Some thinned panels are self-supporting but vulnerable after removal from the cradle, basic consolidation, and rejoining. Their response to environmental changes can be rapid and damaging. In some cases an unattached auxiliary support can offer further protection and stability—more than that provided by careful framing and fitting of backboards. The auxiliary support allows reduced movement of the panel within set limits. The panel is able to become alternately convex and concave with changes in relative humidity (RH) while being retained in the panel tray.

Cradling

The reasoning of the cradle maker when thinning and fitting a cradle to a panel is as follows: The panel is thinned sufficiently to allow it to be flattened without immediate obvious damage occurring, and the cradle is then glued in place. It holds the panel in a flat plane while allowing cross-grain expansion and contraction. The elements glued in the grain direction are sometimes used to reinforce joints, damages, and splits while retaining the sliding battens at suitable intervals. The sliding battens hold the panel in a flat plane and provide rigidity for the complete structure.

Several factors have been either disregarded or underrated in the design and construction of cradles. For example, the influence of the glued members lying parallel to the grain should be considered, inasmuch as the overlying areas of the panel are more stable, more rigid, less hygroscopic, and stronger than the unsupported areas; areas of adjacent stress concentrations close to the glued members (Fig. 1)—where the stress transitions are greatest—can show effects such as those seen in Figure 2a and 2b; the relative freedom of the unsupported areas between the glued members allows them to react to stress and develop “washboarding” from differential movement (Figs. 2b, 3a), and the differential caused by unequal stresses can result in, or exacerbate, blistering and flaking in the ground and paint film. It is important to note that all of these points

Figure 1
 Representative areas of stress concentration (marked by arrows) in a cradled panel.

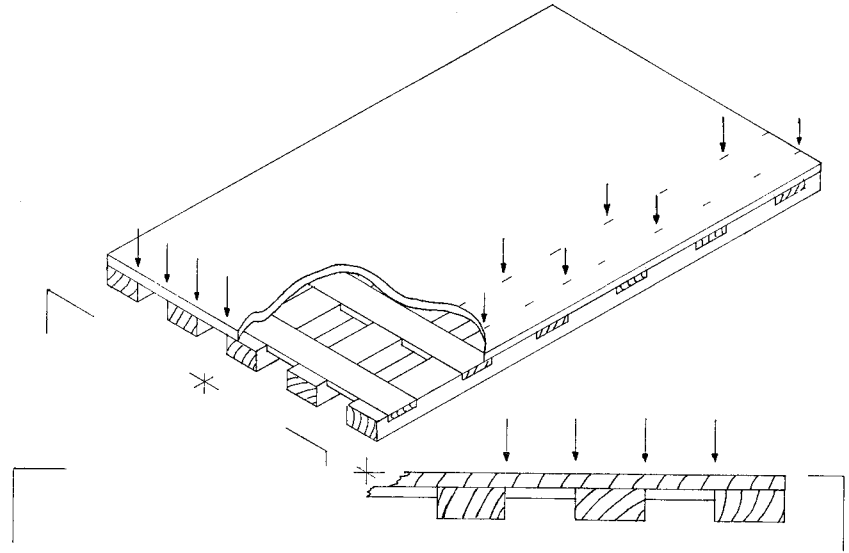

Figure 2a, b
 Damage caused by a cradle (a), and washboarding caused by a cradle (b).

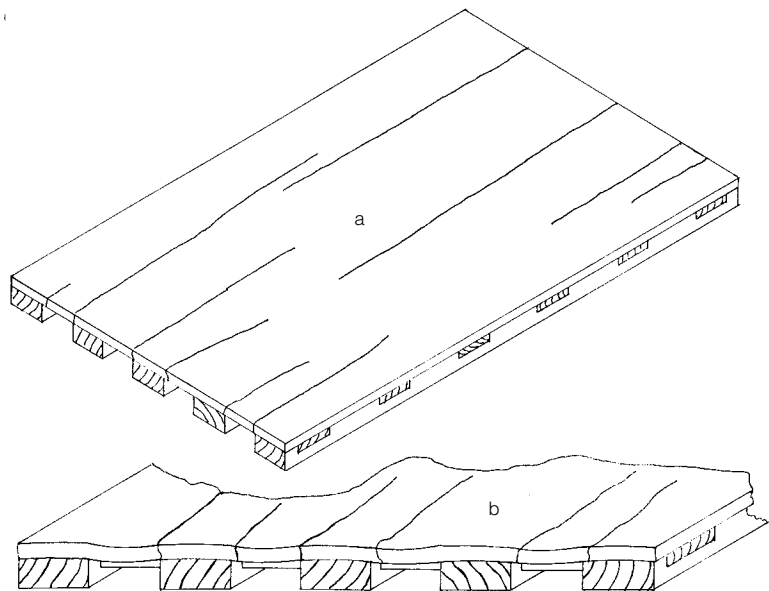
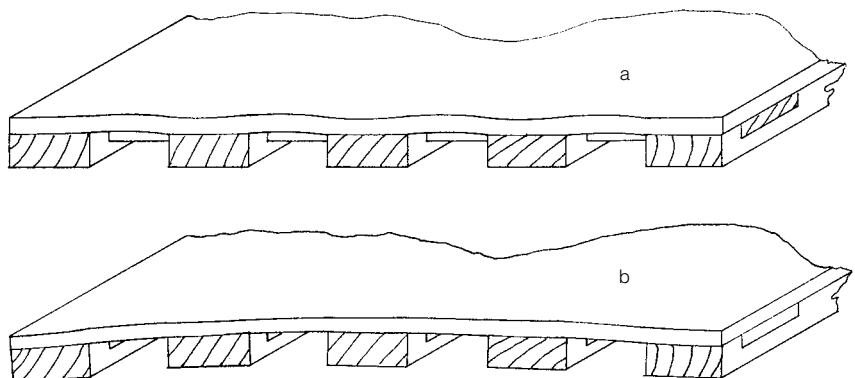

Figure 3a, b
 Washboarding. This phenomenon is more pronounced when the sliding battens are in place (a); note the new camber when the sliding battens are removed (b).



assume the correct functioning of the cradle. In practice, however, many cradles “lock up” (because of inadequate clearance, poor construction, or overgenerous use of glue in assembly), causing the type of damage typically exhibited by functioning cradled panels—although the damage is often more severe.

Modifying the cradle

The type and amount of stress and damage from the factors discussed above will determine the degree of intervention required. Decisions about intervention are made on the basis of experience rather than of analysis. It may be possible to remove the sliding battens from the cradle safely and, by observing the change in curvature, make an assessment of the amount of stress within the panel. The difficulty of removal and the abrupt change in curvature can make this a hazardous procedure, one requiring considerable care and experience. After the removal of the battens, it is important to monitor the movement of the panel through several cycles of low and high RH. It may take some days, depending on the RH required, for the panel to reach an initial equilibrium, such as that shown in Figure 3b.

Some thinned, cradled panels show no signs of obvious damage. Even if it has caused washboarding, a cradle may not appear to have promoted further damage. It may be sufficient (and, indeed, prudent) to ensure the free movement and function of the cradle by one of the following means: removing the sliding battens and sanding them to achieve a looser fit; reducing the thickness of the battens even further to increase their flexibility, a technique that allows the cradle and panel to achieve a degree of curvature, as seen in Figure 4a–d (the relationship between

Figure 4a–d

Side elevations and end views of sliding battens and cradled panels showing reduction in thickness by four methods: (a) the battens relieved on the back face at their tips, a technique that increases cradle flexibility at the outer edges; (b) the battens relieved on the front face at their tips, a technique that increases their flexibility and allows an immediate unrestrained increase in panel curvature at the outer edges; (c) the battens slightly reduced in thickness, a technique that ensures their free movement and the basic functioning of the cradle, with very little increase in cradle flexibility; (d) the battens significantly reduced in thickness, and the consequent gaps in the glued members filled with packing spacers, a technique that increases cradle flexibility.

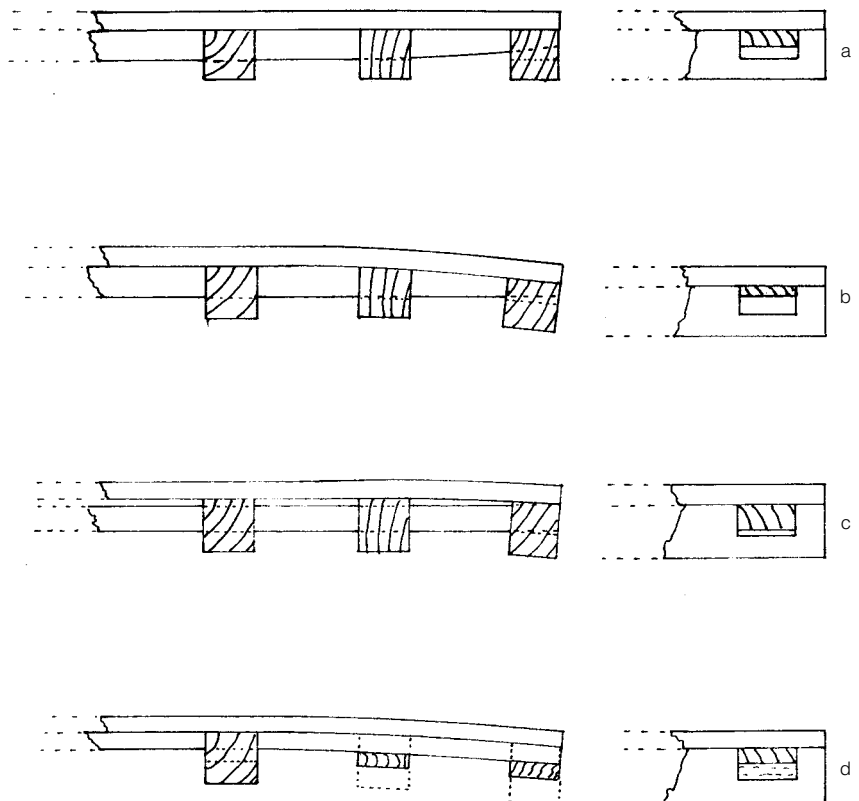

thickness and flexibility is fully explained in Marchant, “Development of a Flexible Attached Auxiliary Support,” herein);¹ or applying self-adhesive Teflon PTFE tape to the sliding battens to reduce friction.² If needed, in addition to easing the cradle, other possible improvements include construction of shaped slips for the frame that follow the panel’s profile; assurance of adequate retention in the frame even while it accommodates some change in curvature without excessive restriction; fitting of backboards, which also offers additional physical protection and slows the rate of moisture exchange; provision of microenvironments (such as microclimate boxes, glazing, and backboards) to stabilize the panel; and control of the environment in the room or display area by attention to heat sources and local hot spots (such as fires and picture lights), drafts, and proximity to windows, outside walls, and direct sunlight. While in many cases these measures may be sufficient, some panels are so stressed or damaged that complete removal of the cradle is essential.

Cradle removal

Although this article does not propose to cover cradle removal in detail, the following points should be considered: humidifying the panel before cradle removal can reduce any sudden changes in curvature;³ making a bed that follows the panel’s curvature and irregularities and safely contains the panel is vital;⁴ and determining in advance the progression or direction of removal is important, as it is possible inadvertently to increase the stress locally while reducing it in another area.

The reaction of the panel to cradle removal may be discernible as having several stages. The removal of the sliding battens can often trigger an immediate increase in curvature. The removal of the glued members down to a veneer thickness may not alter the curvature further. The removal of the remaining veneer and animal glue can sometimes cause the panel to increase its curvature (Fig. 5a–f), although it may occasionally decrease the curvature.

After cradle removal, rejoining, and consolidation of any damaged areas, the panel may be self-supporting, although fragile and difficult to handle safely. In that case, an unattached auxiliary support may be considered as an option to support and protect the panel while allowing it movement.

Size and thickness

In practice it has been found that panels larger than approximately 1 m × 75 cm are not easy to accommodate using this system. Either they are of such thickness that they do not require an unattached auxiliary support or they are too thin, their strength-to-weight ratio being such that an attached auxiliary support is required.

In addition, with a very thin, large panel, the weight alone can trap the bottom edge and reduce the panel’s ability to move with changes in humidity. This may lead to damage, even when Teflon PTFE is used to line the frame/tray rabbet.

Type of wood

There are great variations in the rate and amount of movement among different types of wood, even aside from variations resulting from the cut

Suitability of a Panel for an Unattached Auxiliary Support

Figure 5a-f

When the cradle is removed from a cradled panel (a), the panel (shown in five sections) assumes typical curvature profiles (b-d) as it moves toward an initial equilibrium (f).

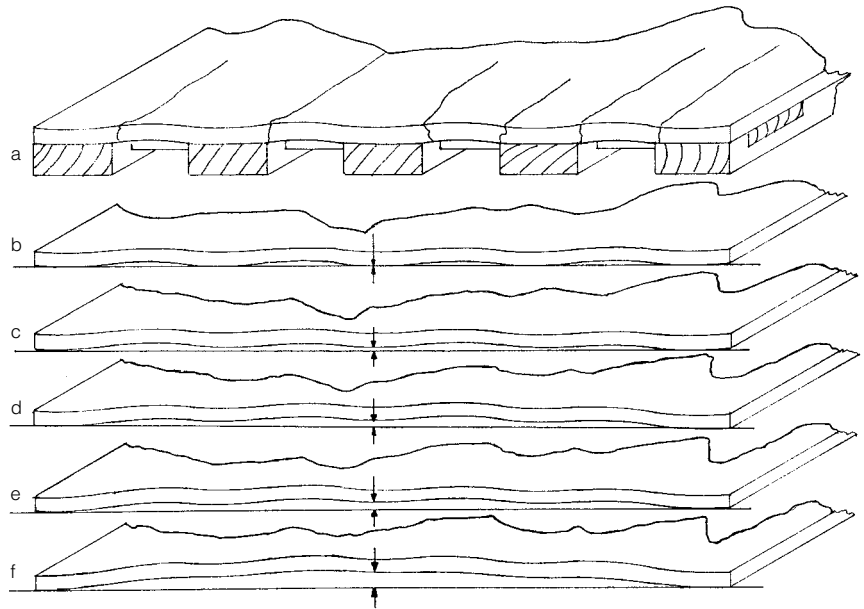

of the timber, irregularities, or damage. No definitive rules can be followed, but the amount of movement a panel is expected to make must be considered. The depth of the frame or tray required will need to be considered if the curvature is expected to be great.

Grain orientation

Preferably, the grain of a painting panel should be vertical, because the endgrain is less prone to accidental damage and compression and is best at load bearing. When the grain is vertical, the flexible battens also function more easily because the bottom edge is less likely to be trapped, as there is no change in the angle of the bottom of the panel in relation to the tray's bottom rabbet. However, a panel with a horizontal grain direction can still be accommodated by the tray and flexible support if attention is paid to the weight of the panel and to its bottom bearing edge with regard to its frictional resistance to movement.

Panel condition

In assessing the condition of a painting panel, several points should be considered, including worm damage; areas of sapwood; timber decay; cracks; checks; repaired splits; original joints and rejoins; buttons,⁵ insets, "butterflies,"⁶ and other kinds of repairs; and any other previous conservation work. All of these can affect the strength and modulus of elasticity⁷ of the panel and must be considered in any assessment. No conclusive advice can be given; however, the conservator must be confident that the panel is strong enough to deflect the auxiliary support safely.

The flexible unattached auxiliary support, described herein as a system for retaining and supporting vulnerable panels while allowing convex and concave movement, could also be considered as an alternative (albeit a time consuming and complicated one) to conventional framing of panels that do not require a support per se. In view of the number of panels that are damaged by misconceived framing techniques, perhaps the greater investment in time would be worthwhile.

Principle of the Auxiliary Spring System

The flexible auxiliary support and tray, in addition to retaining the panel, damp⁸ its movement by applying a measured restraint while allowing convex and concave (or reduced-curvature) movement. The flexible battens accommodate an increase in curvature while encouraging a return to the neutral position against the shaped profile of the panel tray. The back spring accommodates concave or reduced curvature and also encourages a return to the neutral position toward the panel tray profile.

The assembly is composed of several parts: the flexible batten, the back spring, the central bearing, and the bases (Figs. 6–9).

Flexible batten

Flexible battens, if correctly rated for flexibility to the panel, are able to be deflected by the panel. This allows for an increase in curvature when the RH drops (Fig. 10). The interdependency of the flexible batten and the back spring should be noted. The flexibility of the batten is increased toward the tip by one of the following methods:

Tapering of thickness

This method involves the reduction in the thickness of the batten by thinning toward the tip from the center. This reduces the stiffness toward the tip, thus alleviating the problem of all the loads being referred inward toward the central area of the panel and, consequently, increasing the moment⁹ toward the central axis.

Tapering of width

This method (as outlined in Marchant, “Development of a Flexible Attached Auxiliary Support,” herein) is also suitable and may be preferred because graduating the flexibility is more accurate and more easily achieved. (The number and spacing of the flexible battens are covered in

Figure 6a, b

Complete system (a) consisting of a tray, panel, flexible support spring assembly, and backboard; the same components are shown disassembled (b).

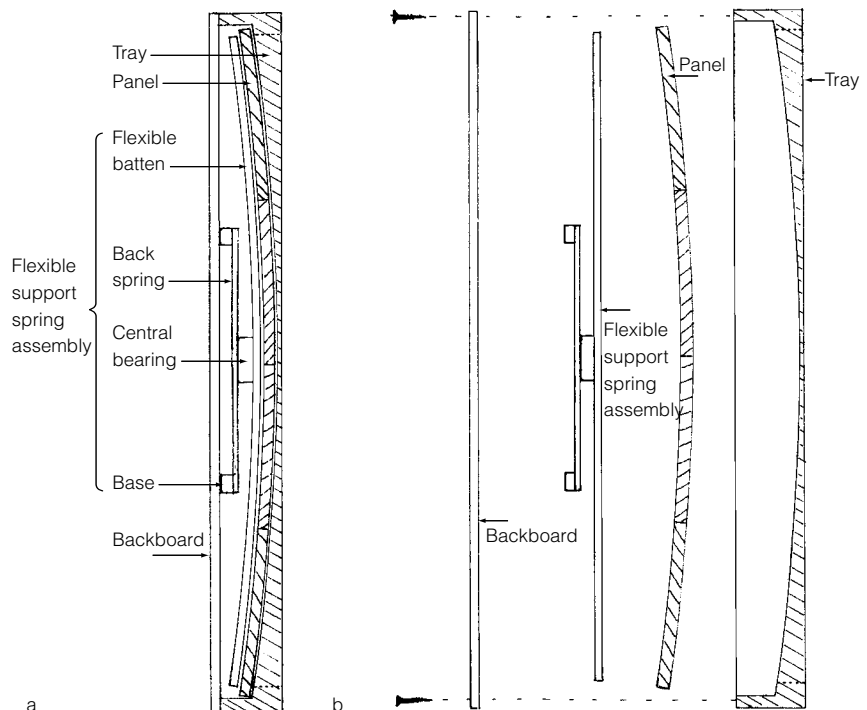

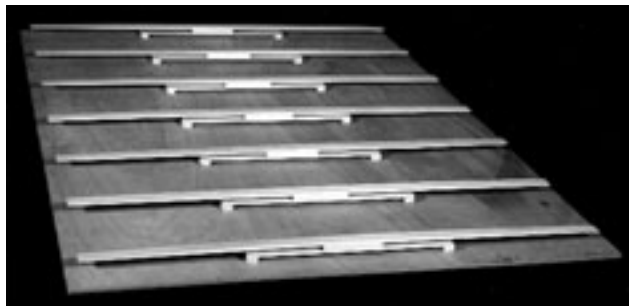

Figure 7, above
Flexible support spring assemblies on a backboard.

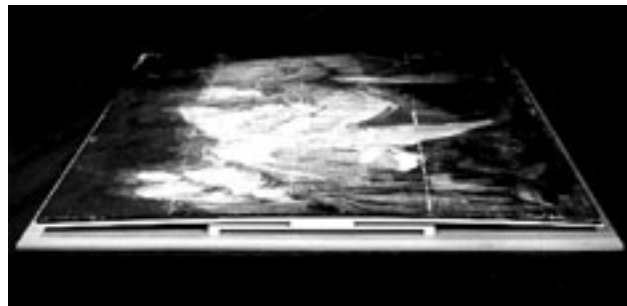

Figure 8, above right
A panel in place on flexible support spring assemblies.



Figure 9, right
Model of the spring support assembly with a panel at a neutral curvature profile (55% RH).

the section entitled “Matching the Support to the Panel,” below.) In all cases the flexibility of the battens and back springs combined must be greater than that of the panel in order to ensure that the support yields to the panel.

Back spring

The flexibility of the back spring will determine the preload that keeps the panel in position against the frame rabbet and the ability of the panel to become concave or to decrease its curvature (Fig. 11). The flexibility of the back spring can be varied by increasing or reducing its width, b , increasing or reducing its thickness, d , or altering its span. These three factors can be adjusted according to the panel’s size, weight, and curvature.

It should be clearly understood that the deflection of the back spring is in a constant ratio to load, and most of the forces generated by the panel will be referred to the central area of the panel parallel to the grain if it becomes concave or reduces its curvature from the neutral slip shape. Thus, of the two flexible parts, the back spring can have the more critical influence. However, this fact should be balanced by the knowledge that most problems occur when panels are restrained from becoming convex (viewed from the front) rather than from becoming concave.

Figure 10, below
Model of the spring support assembly with a panel at an increased curvature (low RH) in comparison to that shown in Figure 9.

Figure 11, below right
Model of the spring support assembly with a panel at a decreased curvature (high RH) in comparison to that shown in Figure 9.

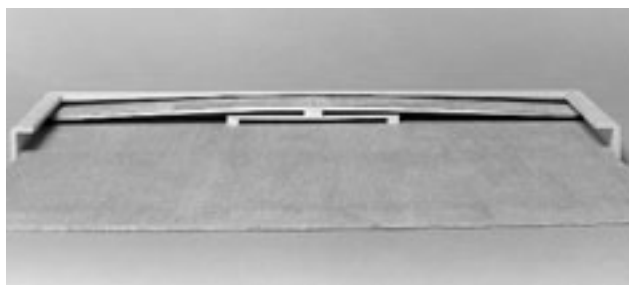

Central bearing

The thickness and area of the central bearing is determined by the maximum curvature expected (Fig. 12a), the available depth within the frame and tray, and the desire to make the bearing as short as possible to reduce the “hard point” in the center of the flexible batten and the back spring.

Bases

These form a bridge enabling the back spring to function. Their area and depth are guided by the same factors as the central bearing. The bases are glued at the ends of the back spring and consequently will reduce the effective span of the back spring by their length.

Only one of the two bases should be fixed to the backboard. If both were glued, then a rigid arch would be formed, and the flexibility of the back spring would be greatly reduced. The maximum height of the bases must allow for the further expected deflection of the back spring. In more recent developments, Plastazote foam,¹⁰ sandwiched between timber, has been used in the bases to allow movement in the back spring when both bases are fixed to the backboard (Fig. 12a, b).

Matching the Support to the Panel

By taking profiles at frequent intervals with the RH constant at 55%,¹¹ it is possible to monitor the curvature of the panel and record its profile when it has reached equilibrium. This curvature, if any, is taken to be the neutral position. When there is regular slight curvature, it is not necessary to shape the battens to the panel, since a small preload is desirable to keep the panel in position against the tray rabbet and to bias the panel’s movement in the preferred direction.

Where the curvature is large or uneven, the batten will need packing to the surface profile of the back of the panel. This is done by the use of short, shaped sections of balsa wood glued to the front of the batten. The balsa grain running at 90° to the batten grain will minimize any change in flexibility (Fig. 13).

Safe deflection of the panel

In order to establish safe deflection, test samples and model panels can be made. Although they must not be relied upon to give analytical informa-

Figure 12a, b
Critical clearance points (marked by arrows)
for maximum (a) and minimum (b) curvature.

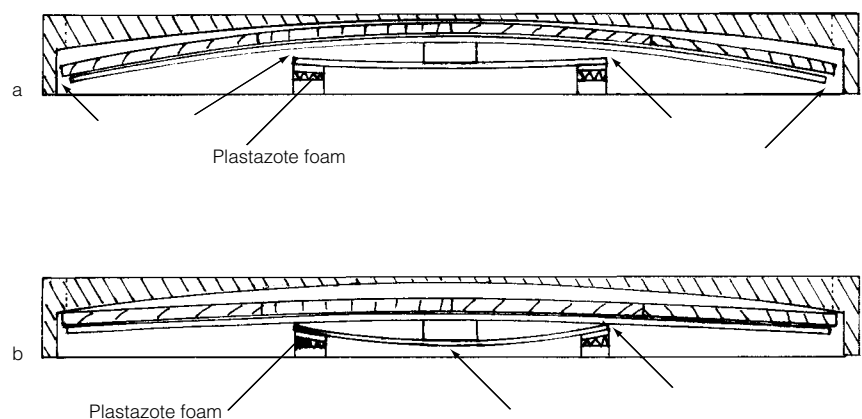
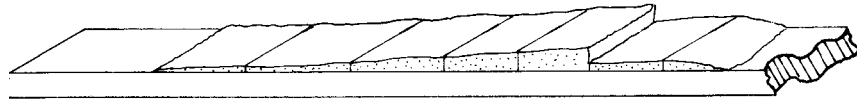

Figure 13

Part of a flexible batten showing cross-grain balsa-wood packing pieces shaped to fit the back of an irregular panel.



tion, they are nevertheless helpful in establishing the broad range of likely forces. Test samples can never represent the exact structure of the panel, its paint and ground layers, or the weaknesses of irregularities and aging. Gently flexing the panel can help to verify sample data and must be done with the greatest possible prudence. A rig using a spring balance or small weights can also relate load to movement.

Once the total safe load for the panel is established (including a safety margin to ensure that the support will yield to the panel), the safe load is divided by the number of elements in the support to find the load per element, which produces a determined deflection. The flexible batten is then thinned to give the determined deflection at that load. The number of elements in the support will be determined by the area of the panel and the length of the panel along the grain. In practice, most panels have spring elements with centers between 100 mm and 150 mm. The back spring must be just stiff enough to ensure that the flexible batten is held fully engaged, in contact with the back of the panel, thus providing an even support. It must not be so stiff that the concave movement of the panel is restricted.

Effect of batten curvature on panel curvature

To summarize, if the neutral curvature profile of the flexible batten is less than that of the panel, then the panel will be moved toward a flatter plane. If the neutral curvature profile of the flexible batten and that of the panel are the same, then the panel will have no tendency toward either concave or convex movement. Thus it is possible to tailor the spring system to encourage a panel toward a flatter plane.

Construction

The timber used is Sitka spruce (*Picea sitchensis*). It is straight grained, largely free of faults, light, elastic, and of consistent density. It has been used in aircraft construction for more than ninety years and is available with aircraft release notes.¹² The face of the flexible battens touching the verso of the panel can be covered with felt or cotton tapes to protect the panel from abrasion. The panel tray is constructed from hardwood (mahogany or a similar wood) to achieve rigidity for a minimum size of section. Saw kerfs¹³ can be cut in the mitered corners and hardwood tongues glued in place to increase rigidity (Fig. 14). This method is especially good for small trays when the timber section is insubstantial. In some cases there may be insufficient space for a tray within an existing frame; it may be possible to use the frame as the basis for the shaped slip pieces and to build up the sides of the rabbet so as to make the frame effectively into the tray. The backboard and spring supports may be fitted by the same method.

All four sides of the panel have their profiles taken, and these are transferred onto the tray edging section. It is generally easier to construct the shaped profiles and glue them into a basic section than to carve them

Figure 14

The corner of a panel tray showing saw kerfs in which hardwood veneers have been inserted, to increase rigidity and the strength of the joint.

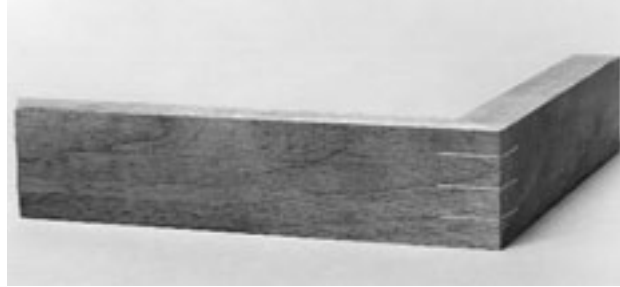

out of the solid wood. Many panels have a propeller-like twist in addition to any curvature. Such twisting must be carefully considered when establishing datums for construction within the tray in order to balance the diagonal distortion evenly.

All visible edges of the tray can be toned, gilded, and distressed to match the existing frame. Frequently the sight size of the frame is too large, and consequently part of the tray's edge can be made to project beyond the rabbet and become visible as an inner slip.

The backboard is made of marine-quality plywood,¹⁴ which may be obtained with good-quality veneers. Other stable sheet materials may be used, the choice being made on rigidity, thickness, weight, and appearance. The backboard must be strong enough to withstand the loads imposed by the support with little deflection.

The panel is placed in the tray and retained by the spring supports and backboard. The backboard is then screwed into the tray edge section. Finally, the completed assembly is fitted into the frame with brass strips and screws.

Assessment of the Unattached Flexible Auxiliary Support System

There are disadvantages to the flexible unattached auxiliary support system: it is only suitable for a limited range of panels; the assessment of forces and panel strength is largely empiric; some panels and frames will not accept a deep tray without the result appearing ungainly; and it is not possible to see the back of the panel without the removal of the backboard and support. Despite these limitations, there are several advantages to the system. For example, there is a minimum of interference with the original panel; concave and convex movement of the panel is possible without overstressing; known forces are applied to the panel; the panel's movement within the tray indicates changes in RH and alerts conservators to inadequate RH control; RH changes are buffered by the tray and backboard; and physical protection of the panel is provided—an especially important consideration when the panel is out of the frame.

Notes

1 $I = bd^3 \div 12$, where: I = moment of inertia; b = breadth (width); and d = depth (thickness).

With a constant thickness, d , if the width, b , is halved, the deflection for the same load will double. If d is halved, the deflection will increase by eight times with the same load (see Marchant, "Development of a Flexible Attached Auxiliary Support," herein).

2 Teflon PTFE (polytetrafluoroethylene) is a tape with very good properties for reducing friction.

3 To humidify a panel, the RH in the room may be increased to 65–70% for several days to reduce the stress within the panel if the convex curvature is expected to be large.

- 4 A bed may be made from a prepared board that is packed with balsa wood strips of varying size and thickness to support the panel over its entire surface during cradle removal. While the cradle is being removed, it will need to be adjusted continually if the curvature alters.
- 5 Buttons, also known as cleats, are the rectangular reinforcing blocks frequently glued over the back of the panel to repair cracks. While they are generally cut into the surface, they may be left "proud."
- 6 Butterflies are the bow-tie or butterfly-shaped repair blocks often cut into the back of the panel to reinforce cracks, splits, and joins.
- 7 The modulus of elasticity is constant for a particular material. It is the force above which the panel will deform or be damaged and not return to its original condition by elastic behavior.
- 8 To damp the movement of the panel is to reduce the amplitude of the cycles.
- 9 The moment is the product of the force and the distance from its point of action.
- 10 Plastazote foam is a closed-cell, cross-linked polyethylene foam (see Materials and Suppliers).
- 11 In the United Kingdom, 55% RH is generally considered the best average humidity in which to keep panel paintings.
- 12 In the United Kingdom, aircraft release notes identify timber that is tested to Civil Aviation Authority standards, for consistency of density, quality, and moisture content.
- 13 Slits made by a saw blade.
- 14 British Standard 1088 signifies "marine quality," indicating that the stability and quality of construction are assured by testing. It is not the same as waterproof plywood (WPB), which is produced to a lower standard.

Materials and Suppliers

Plastazote foam (REF LD 24), BXL Plastics, Mitcham Road, Croydon, Surrey CR9 3AL, U.K. (distributed by Hemisphere Rubber Co., 65 Fairview Road, Norbury, London SW16 5PX, U.K.).

Teflon PTFE, CHR Industries, 407 East Street, New Haven, CT 06509. European supplier: Furon CHR Products, P.O. Box 124, 7640 AC Wierden, Netherlands. United Kingdom distributor: Polypenco, now part of DSM Engineering Plastic Products UK, 83 Bridge Road East, Welwyn Garden City, Hertfordshire AL7 1LA, U.K. (The PTFE tape is marketed as Temp-r-tape HM series.)

The Development of a Flexible Attached Auxiliary Support

Raymond Marchant

MOST PANEL MOUNTING and display requirements can be achieved with conventional methods of framing and retention, but occasionally a difficult problem will arise in which recognized methods of support are inadequate. This article documents the development of an alternative approach to some of the more difficult problems encountered in the support of weak or responsive panels.

First Case Study

Description

One such problem occurred in 1989 with the conservation of a large sixteenth-century Flemish panel. The painting, measuring 1.2×1.7 m, consisted of six oak boards joined horizontally. It had been thinned to between 6 mm and 8 mm and had a late-nineteenth-century heavy pine cradle attached, constructed from nine fixed horizontal members, each measuring 50 mm wide \times 25 mm thick, and six vertical sliding battens, each 60 mm wide \times 15 mm thick.

As with so many cradles of this period, the device exhibited good workmanship but was intended to flatten the panel. Because the cradle was of a rigid construction with minimum tolerances allowed for movement of the sliding battens, it was potentially damaging. Subsequent to the cradle's installation, variations in environmental conditions caused the panel's moisture content, and hence its curvature, to alter. The cradle could only accommodate a small change in the panel's warp before the battens became locked, preventing further movement. Stresses then developed, causing fracturing and partial disjoints to occur in a number of places on the panel. An assessment of the condition of the painted surface showed that many of the structural faults had produced corresponding damages to the ground and paint layers.

When the panel arrived for treatment, its profile viewed from the front was concave, and the cradle was totally seized. The panel painting was in very poor structural condition and the concern was that it would deteriorate further. It was considered that just freeing the sliding elements of the cradle would not provide an adequate solution to many of the problems. Therefore, it was decided that removal of the cradle was necessary to complete the repairs satisfactorily, as well as to ensure future stability.

Structural condition

When the cradle was removed, the extent of the weaknesses and damage to the panel could be fully appreciated. One fracture, which ran almost the whole length of the panel, had occurred in an area of worm-damaged sapwood adjacent to a join. The fracture was so severe that one of the board sections was virtually hinged to the main body of the panel only by a number of small areas of intact fibers.

There were also traces of two 10 cm wide cross-grain channels across the panel that could just be discerned in the thinned surface. These traces indicated that battens may have been present before the cradle was fitted. Exposed dowels showed that the panel's original thickness had been reduced by about half when it was thinned. It was likely that this panel had had a history of structural problems long before the cradle was fitted.

After structural repairs, rejoins, and consolidation had been carried out, the panel's cross-grain profile was monitored and recorded several times during a period when the relative humidity (RH) was allowed to vary widely. To judge the panel's response to likely extremes of environmental conditions, its profile was recorded at 40%, 55%, and 75% RH, and its condition was reassessed. Monitoring was carried out with the panel standing vertically on its endgrain.

Released from the cradle, the panel's profile altered considerably, becoming convex when viewed from the front and responding quickly to even small changes in RH. Because of its thinness, the strength-to-weight ratio, although improved by repairs, was so poor that it could be handled only with great care. If laid horizontally, it was subject to the risk of fracture if any attempt had been made to lift it by one of the long-grain edges.

Another cause for concern was an area of severe worm damage, again in a band of sapwood extending across the board, close to the bottom, supporting edge. This weak edge would be subject to damaging forces imposed by the weight of the panel bearing on it and the need for it to move to accommodate changes of curvature. If this natural tendency to warp were again restricted by a rigid secondary support, further damage—caused by compression and/or tension perpendicular to the grain—would be likely to occur.

Identifying the need for an attached auxiliary support

It was apparent that if the panel were to remain stable without suffering further damage, a method of support other than those normally used was needed. Because the problems presented by this panel were known to be difficult to resolve satisfactorily, it was decided that the options should be considered very carefully before a course of action was decided upon. Conventional techniques of support and retention of RH-responsive panels include sprung-metal clips, secured within a frame rabbet; a foam-cushioned panel tray support (Brough and Dunkerton 1984); and unattached auxiliary flexible supports (see Bobak, "A Flexible Unattached Auxiliary Support," herein).

In these examples of unattached supports we find a common principle: retainers exert pressure on the back of the panel, and this pressure—frequently concentrated around the perimeter or on the line of the central long-grain axis—is balanced by the reaction of the lip of the frame rabbet acting against the edge of the face of the panel.

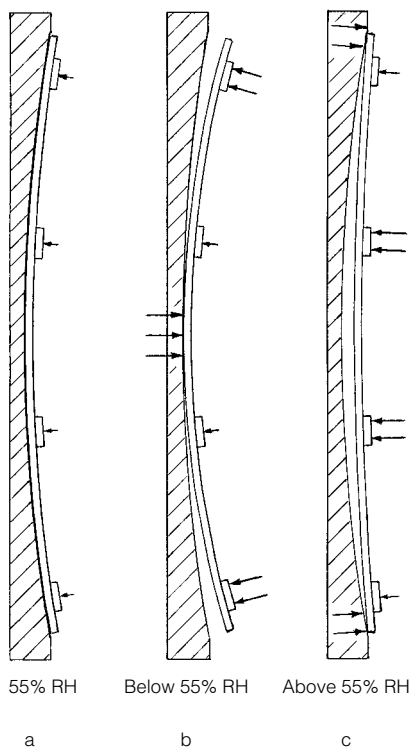

Figure 1a-c

A panel retained against a slip profile using spring framing clips. The magnitude of pressure at these points and the reaction of the profiled support is shown by the arrows. At 55% RH (a), minimum pressure is applied at four retaining points. Below and above 55% RH (b, c), the magnitude of pressure increases and the reaction of the profiled support is concentrated at the contact points. These forces would be similar if other unattached support systems were used as a method of retention.

For a self-supporting panel, a shaped slip would normally be made to suit the panel profile when the panel is stabilized at 55% RH. If environmental conditions remain stable, good contact should be maintained with the shaped slip on all four edges, and only small, balanced reaction forces will result (Fig. 1a). Problems can arise, however, as soon as conditions change (Fig. 1b, c).

Figure 1 shows a panel's response to environmental changes. Differential absorption or loss of moisture content in the panel, due to changes in RH, cause it to warp (Thomson 1978:208-10). The opposing forces illustrated in Figure 1b and 1c may result in bending stresses, which in an already weak panel could result in fracture. These adverse effects are further accentuated when the grain runs horizontally, because the weight of the panel resting on its supporting edge causes frictional resistance to the movement needed to accommodate a change in curvature. In large panels, forces can be magnified by leverage to produce dangerously high concentrations of stress some distance from where the resistance to movement occurs. If an area of weakness exists, failure is likely to occur there. Under these circumstances, the use of one of these types of secondary supports would not be satisfactory.

Having fully assessed the condition of a panel, the panel conservator must make a decision as to whether an attached support will be necessary. After removal of a cradle or damaging support from a panel, it would be preferable not to have to make any further attachment. However, there are circumstances in which this measure cannot be avoided.

As a general rule, if an unframed panel cannot be handled confidently or will not safely support its own weight when placed horizontally on a surface, then an attached support should be considered in order to provide the required reinforcement. It is almost impossible to reinforce a weak panel without using an attached support. But an attached support can be designed to ensure that it is in sympathy with the panel's requirements.

A reinforcing structure is required to help strengthen a weak panel and assist in spreading stresses more uniformly. The other function of a secondary support in this situation should be to act as a restraint by allowing changes of curvature to take place in a controlled manner and within predetermined limits. Therefore, the secondary support should be flexible. This design concept was successfully established by Simon Bobak (see "A Flexible Unattached Auxiliary Support," herein) for the unattached support of small panels but would need considerable development before it could be applied to an attached support for large, heavy panels.

Batten design

In an attempt to design an attached support that would fulfill these basic requirements, an analysis was first made of the effect of attaching a uniform rectangular-section batten to a curved surface. It was hoped that this would also provide a better understanding of why some cradles, even if they allow movement, still have a damaging effect on panels.

The simplified representations in Figure 2a-d show curves achieved by loading a uniform rectangular-section batten. The curvature of the panel is shown exaggerated as an arc with a constant radius of curvature (Figs. 2a, b). The batten is deflected within the arc by the application of a force at its center (Fig. 2b). This situation may also be represented diagrammatically as a simply supported beam loaded at its center (Fig. 2d).

Figure 2a-d

A uniform rectangular-section batten deflected within an arc by a force at its center. A section of panel is shown (a) with constant radius of curvature and a straight uniform-section flexible batten. The batten deflected by a force (W) at its center (b) contacts the curved surface only at the center and the outer edges. A batten supported horizontally at its center (c) deflects in the same way as in b and d when supporting the weight of a curved panel. A batten simply supported at its ends and loaded at its center (d) deflects into a parabolic curve.

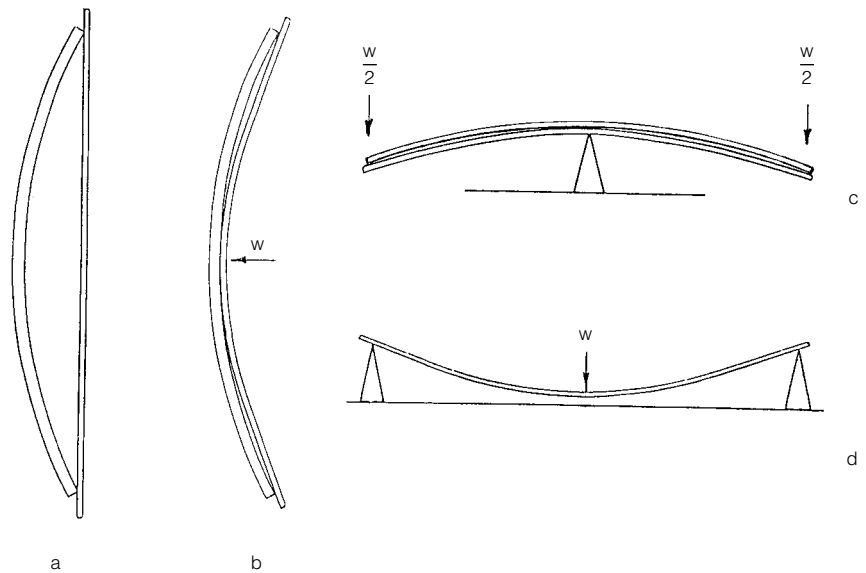

If the batten is deflected within the arc by a force at its center, the only point of contact with the arc other than the outer edges will be at the center. The deflection curve in Figure 2b will be the same as that represented in Figure 2d. It will not have an equal radius of curvature over its length but will be straighter toward its ends in the form of a parabolic curve.

To produce contact with the arc at points toward the ends of the batten, greater force would be required at those points to make the batten deflect. If the uniform rectangular-section batten were to be attached at a number of points to the curved surface, as in Figure 2b, it would have a greater straightening effect on the surface (inducing greater tension at the attachment points) toward the outer edges. To avoid the problem of creating high stress toward the edges of panels (which occurs with many conventional cradles), the battens should be made progressively weaker toward the ends.

Shape and section

Ideally, therefore, a batten is needed that would have an equal straightening effect at all points along its length. To produce a batten that will bend with a constant radius of curvature under the conditions outlined, it is useful to understand some basic structural theory. The relationship between stress and curvature of a member when subjected to a simple bending moment is given by the equation:

$$\frac{M}{I} = \frac{E}{R}$$

where: M is the bending moment (a function of load and distance); I is the moment of inertia of the section (a function of breadth and depth); E is the modulus of elasticity¹ of the material (a constant); and R is the radius of curvature.

Therefore, for R to be constant along the length of the batten, EI/M must also be constant. As M decreases linearly away from the center toward the ends and E is not variable, then I must decrease in the same

ratio as M . As $I = bd^3 \div 12$, either the breadth, b , or the depth, d , could be chosen as the variable factor to produce the linear decrease.

The breadth of a rectangular-section member is directly proportional to its deflection—that is, if the breadth, b , is doubled, then twice the load is required to produce the same deflection. But if the depth, d , or thickness, is varied, the stiffness will alter as the cube of d . That is, if the thickness is doubled, then eight times the load needs to be applied to produce the same deflection, or if the thickness were halved, then under the same applied load, the deflection would increase eight times.

It follows that it would be difficult to produce the linear decrease required if thickness were chosen as the variable factor. The resulting batten would have a complex curved profile that would be difficult to determine and to execute accurately (Fig. 3a).

The alternative is to vary the width. Simply reducing the width at a constant rate from the center toward the end satisfies the conditions for producing a configuration of section which will deflect into the uniform curve required (Fig. 3b).

This shape of section is easy to produce. Its flexibility can be increased simply by reducing its thickness, and because it is a flat section, it is easy to incorporate into a support system. If this tapered batten is now brought into contact with a curved surface until it deflects, it will conform more closely to the surface profile. If a number of attachment points are made so that the batten has a straightening effect on the curved surface, the tension at those points will be more equally spread, producing an even restraint.

If calculations are made for deflection based on a uniform rectangular section, which then has its width tapered, the deflection will increase by about 50%. Allowance can be made for this. It is preferable, however, to err on the side of flexibility. An excessively stiff support may damage the panel, but problems are unlikely to occur if the support is too flexible. It should be able to yield to the bending force exerted against it by the panel.

To achieve reliable results from calculations, a suitable timber needs to be specified. The timber chosen for the lattice components was Sitka spruce,² which has excellent properties for this type of application. It can be obtained in large, straight-grained, knot-free sections. It is also light but strong, with consistent characteristics of flexibility (i.e., E values).

Figure 3a, b
Two configurations of batten shapes that deflect with a uniform radius of curvature.

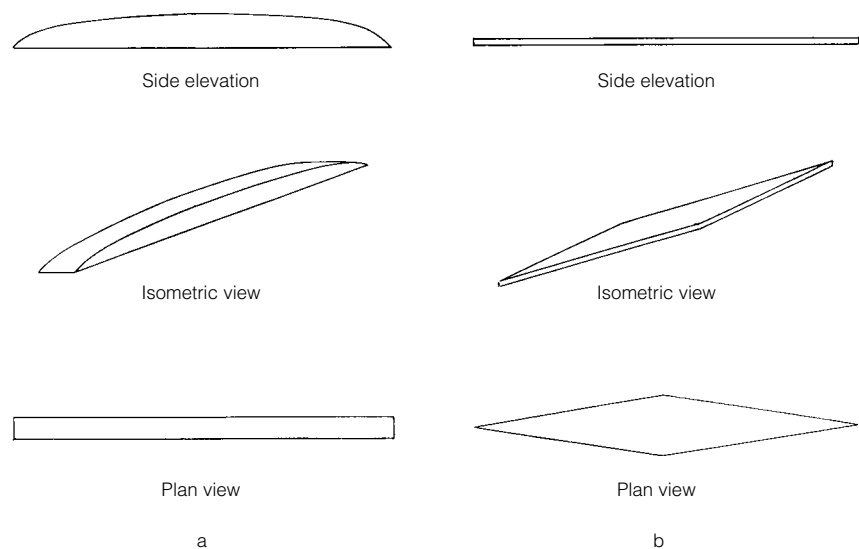

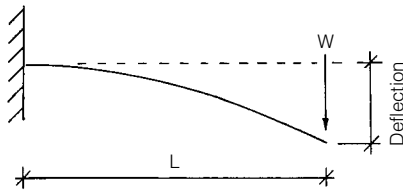

Figure 4
Diagram of a cantilever deflected by point load at end. $W =$ load; $L =$ length of cantilever.

Calculating batten flexibility

To calculate the required flexibility of a batten for restraint, it is necessary to know what bending force will be exerted against it by the panel. When environmental conditions alter, moisture transference in the panel structure generates internal forces. This bending force will produce pressure against anything that restrains the panel from changing its curvature. It is possible to measure empirically how much resistance is necessary to counteract this change, but with a fragile panel, there is the risk that it may fracture before any relevant information is obtained. It is not possible to predict the resistance to bending that a weak panel will withstand before it fails; therefore, some other means of assessing a loading figure for the batten needs to be found. This can be done by considering reinforcement rather than restraint.

For simplicity, the calculation example that follows is based on a batten supported at its center treated as a cantilever, with a fraction of the panel weight used as the load figure (Fig. 4). (This concept will be explained more fully in the section below entitled "Evaluation of batten flexibility.")

For a cantilever, the deflection (Δ) at the end under a single point load is given by the equation:

$$\Delta = \frac{WL^3}{3EI}$$

where: $\Delta =$ deflection; $W =$ load; $L =$ length of cantilever; $E =$ modulus of elasticity;³ and $I =$ moment of inertia.

Example. The following is a calculation of the thickness of the battens that will support the weight of a panel horizontally within a known deflection. All other factors have been specified, including the number, length, and width of the battens and what is considered to be a safe limit of deflection of the panel.

Deflection (Δ)	30 mm	
Panel weight	22 kg	
Number of battens	10	Load at each end of each batten = 1.1 kg
		Therefore, $W = 1.1 \times 9.80665 = 10.787$
Length of batten	1200 mm	
Cantilever length (L)	600 mm	
Width of batten (b)	50 mm	
Modulus of elasticity for Sitka spruce,		
$E = 11100.6 \text{ n mm}^{-2}$		

Moment of inertia, $I = \frac{bd^3}{12}$

$\Delta = \frac{WL^3}{3EI}$ Therefore, $I = \frac{WL^3}{3E\Delta}$

$\frac{bd^3}{12} = \frac{WL^3}{3E\Delta}$ $d^3 = \frac{12WL^3}{3E\Delta b}$

$d^3 = \frac{12 \times 10.787 \times 600 \times 600 \times 600}{3 \times 11100.6 \times 30 \times 50}$

$d^3 = \frac{10.787 \times 576000}{11100.6} = \frac{621.9}{1.11006}$

$d = \sqrt[3]{560.24} = 8.25 \text{ mm}$

Therefore, thickness of batten, $d = 8.25 \text{ mm}$

The results of calculations are easily verified using prepared sample battens and weights. It is not suggested that support battens be specified purely by theoretical calculations but rather that calculations may serve as a useful shortcut to produce sample sections for empiric evaluation. It then becomes a question of judgment based on experience to decide whether, or by how much, to alter such a batten to suit the particular requirement.

It should also be stressed that even for those with no understanding of structural design theory, there is at least one important relationship included in the equations that should be recognized. This is the correlation between section thickness and flexibility (as discussed above). In the design of a secondary support, or even in the thinning of battens to ease an existing cradle, the result of reducing thickness by what may appear to be only a small amount can have a very dramatic effect on the flexibility of the support. Conversely, it is very easy to produce an auxiliary support many times more rigid than is necessary to perform its function—with a consequent risk of damaging the panel.

Method of attachment

With the form that the flexible battens should take having been established in principle, the next problem to consider was the method of attachment to the panel.

The main factors to consider were as follows: It should not be possible for the battens to seize, thus restricting dimensional changes in the panel. The attachment of retaining points to the panel should be achieved without the creation of rigid glue areas that are larger than necessary or that extend too far across the grain, as this could contribute to the characteristic “washboard” effect and the tendency to fracture at the transition edges of glue areas. And it would be an advantage if the means of attachment allowed for removal of the battens.

All of these basic requirements were achieved by the use of flexible retaining strips against the surface of the battens, held in place parallel to the panel grain with slotted retaining blocks glued to the panel. The blocks were made narrow in the cross-grain direction, and their size was limited according to the number used. The greater the number of blocks, the less tension each had to bear individually and the smaller the glue area needed for safe attachment. For compatibility with the panel, the blocks were made of oak. Evo-Stik polyvinyl acetate (PVA) wood-working adhesive was used for the glue joins.⁴ The number of retaining strips, and hence the distribution of blocks, is determined by such factors as the number of boards making up the panel,⁵ surface irregularities that may make attachment points difficult, areas of weakness that should be avoided, and original features that one would prefer to leave unobstructed.

Using retaining strips against the face of the battens instead of anchoring the battens directly to the panel ensured that there was little risk of seizure occurring. However, it was also necessary to stop the individual battens from moving and becoming misaligned. This was done by linking them together in an accurately spaced configuration, with thin, flat timber strips used to create a lattice.

Finally, a supporting timber section was made to fit under the bottom edge of the panel. This skid strip was joined to the tips of the lattice. It provided protection for the weak load-bearing edge, as well as providing

Figure 5

Back of sixteenth-century Flemish oak panel (first case study), 1.2 × 1.7 m, after structural conservation, with flexible auxiliary support engaged, providing reinforcement.

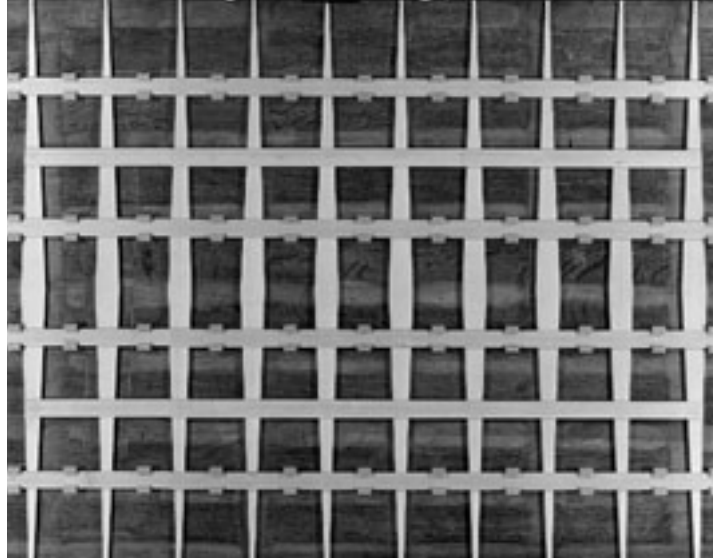

a smooth, flat surface to aid movement, reducing the risk that the panel would stick in the frame rabbet or tray. Free movement was further improved by using Teflon/PTFE (polytetrafluoroethylene) pressure-sensitive adhesive tape⁶ to line the rabbet.

Upon completion, the support lattice was attached to the panel by engagement of the flexible strips in position in the retaining blocks (Fig. 5). When this procedure was done, the panel tended to flatten out slightly and, when handled, could be felt to be appreciably less flexible than before the auxiliary support was in place.

Monitoring panel warp

At this stage, the slip profile was considered. Assuming that enough time has been available, the panel should preferably have had its end-grain profiles monitored and recorded three times during cycles of RH—initially with whatever cradle or restriction was in place when the panel arrived for treatment; again, with restrictions removed and the panel totally free to respond; and, finally, with the new support attached. This profile would be expected to fall somewhere between the first two recorded profiles.

Consideration should also be given to simulating the conditions under which the panel is going to be displayed in the future. In some countries the extremes of RH may be outside of the limits normally used in a monitoring cycle (i.e., 40–80% RH). After the slip profile has been determined by monitoring under appropriate conditions⁷ with the support attached, some thought can be given to the depth of the tray or rabbet. This depth needs to be sufficient to accommodate the anticipated extreme limits of movement of the panel; it should also be adequate for the spring bridge supports, which will be used to hold the assembly in place within the frame.

Back springs

The principle of using back springs was conceived by Simon Bobak (see “A Flexible Unattached Auxiliary Support,” herein) for use on unattached supports. It consists of individual flexible battens, each attached by a center

pad to a spring bridging strip, with feet at each end for mounting on the backboard (Fig. 6a).

This arrangement, which allows both increase and decrease of curvature to take place in the panel while it maintains contact with the support, was retained in principle but modified to suit the new lattice design (Fig. 6b).

It was considered that one function of the action of the bridges could be improved if they were inverted with both feet mounted onto the battens, thus providing two reasonably spaced points of pressure against the battens. This arrangement would encourage return movement equally of the top and bottom of the panel to a neutral position, when the curvature reduces, rather than the panel pivoting on the center pads. In order that both feet could be mounted on a surface with variable curvature, the timber pads were given a Plastazote⁸ foam core, allowing them to adjust to the changes. The pressure pad, which would now be in contact with the backboard, was also made into a timber-foam sandwich so as to prevent the creation of a rigid area being in the center of the spring strip. The modification to the pads improves the overall cushioning effect and allows differential changes of curvature, dimension, and alignment to be absorbed.

Another advantage gained by inverting the bridges is that a narrow bar can be used to bear against the pressure pads. Previously, if a bar were used, it would have had to be wide enough to engage both bridge feet, or else a backboard would have had to be rigid enough to take the spring pressure without bowing.

If a retaining bar is used to take the spring pressure, then the backboard can be reduced in thickness and weight (which may be considerable on a large panel) and can then act purely as a lightweight environmental barrier (Fig. 6c illustrates this later development). The position of the bar should be such that it engages to produce a slight preload of the spring bridges just adequate to retain the panel against the slip profile. (Note: Most pressure will occur against the bar during high RH, when the panel will tend to flatten, producing a far greater deflection of the spring bridges than when curvature increases.) In this particular case, the backboard was a single sheet of plywood with a reinforcing section of timber glued to the underside to stiffen it (Fig. 6b). In later supports, the improvement of a rigid framing bar was adopted.

Evaluation of batten flexibility

Throughout this development, probably the most difficult judgment to make was to determine the degree of stiffness or flexibility of the support lattice to match the panel's requirements. With experience, it is possible to make a reasonable assessment of the strength of small panels, but when a panel is so large that it cannot safely be lifted, handled, and flexed by one person, this becomes very difficult. Even when it is within a manageable size, it is not easy to evaluate hidden weaknesses resulting from small fractures, compression damage, and structural deterioration resulting from age. *E* values (modulus of elasticity) cannot be used to assess strength (resistance to bending) in the cross-grain direction. Tables of *E* values for timber only apply to bending at points along an axis parallel to the grain.⁹

Figure 6a-c

The main stages in the development of an auxiliary support system. With an unattached support (a), when the backboard is removed, the spring bridges and battens joined to it come away, leaving the panel loose in the frame. With an attached support, in its earliest development (b), spring bridges are inverted and attached to battens. When the backboard is removed, the panel and secondary support remain loose in the frame. With an attached support, in its later development (c), the panel and secondary support are retained by a framing bar. When the backboard is removed, the panel remains secure in the frame.

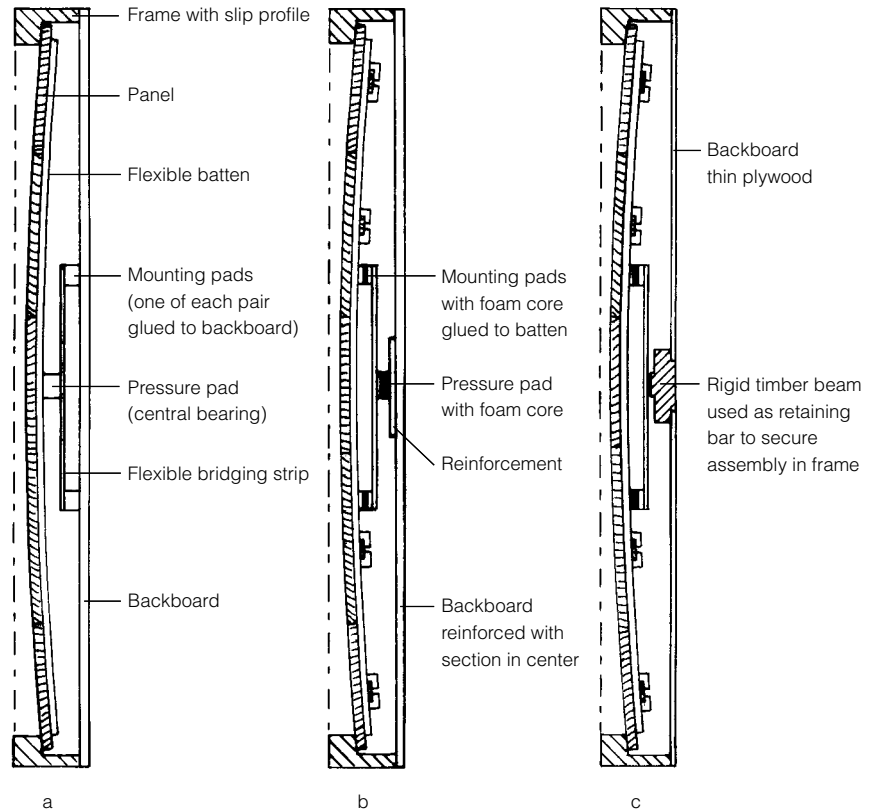

Panel weight as a factor in evaluation

During the development of this type of auxiliary support, the first panel to be assessed had lines of weakness caused by fractures and worm damage, which made evaluation of its strength very difficult. Due to its areas of weakness, the panel was assumed to have little or no inherent strength. The intention of calculating a lattice flexibility was to find one that would provide the reinforcement to support the weight of the panel horizontally within a safe limit of deflection.

The known factors upon which a judgment could be based for the lattice flexibility were the weight of the panel and the change in curvature, monitored at the lower limit of RH that the panel might reasonably be expected to be subjected to in the future, measured at the outer long-grain edges of the panel as the dimensional deflection from the center. The panel weight, divided by twice the number of battens in the lattice, was taken as the load that, when applied to one end of a batten, would produce a similar deflection from the center as that previously measured in the panel. Tapered battens were then produced to give the specified flexibility. The result was that when the lattice assembly of battens was placed horizontally on a central support and the panel placed on top, the panel weight was adequately supported without the determined safe deflection being exceeded. The degree of rigidity of the support was therefore considered correct for reinforcement.

When the support lattice was completed and anchored to the panel, the assembly was evaluated in the vertical plane and found to give a satisfactory degree of restraint—it reduced the panel's previous curvature by about 30%. The panel could also be handled with much more confidence. It

was not considered necessary to alter the lattice, and the project was completed by mounting the assembly in a tray with a spring-bridge support behind the lattice. The overall result appeared to be perfectly adequate even though the original design data were so limited.

This method of estimating the lattice flexibility has since been used successfully on other panels; therefore, although it may appear to be an arbitrary assessment, the results justify its use until a better method of calculation can be found.

Second Case Study: Support for a Panel with an Irregular Surface

Panels that have been cradled have frequently been thinned or have had some surface preparation to enable the cradle to be fitted. While such previous changes may have contributed to harmful effects suffered by the panel, they also make the attachment of another auxiliary support relatively straightforward.

Recently, conservation work was undertaken on a panel for which it was appropriate to use a flexible attached auxiliary support. The panel had not, however, been cradled or thinned, and consequently, the attachment of the support to an irregular surface presented some difficult problems.

Description

The seventeenth-century Flemish painting *Death of Orpheus*, by Alexander Keirinx and Roelant Savery,¹⁰ measures 1.4×2.03 m; it is made up of six oak boards with doweled and glued horizontal joins. Early in its history, following some poor board rejoins, an attempt was made to flatten the panel. Four rigid poplar battens, each 100 mm wide, were glued into trenched rabbets across the grain of the boards. Shrinkage of the boards had then caused partial disjoins and some fracturing. In a misconceived attempt to prevent further damage, butterfly cleats were inserted across the board joins, while the cross-grain battens were left in place. These cleats were deeply recessed, with their grain perpendicular to that of the boards. As would be expected from these contradictory interventions, further damage had occurred in the form of fractures at the outer edges of the butterflies.

Some of the small butterfly cleats had been removed and even larger ones inserted, causing further fracturing. When the glued surface joins of the battens failed, the battens were reglued and their ends screwed to the outer edges of the panel. In one area on the bottom board, this had recently caused a severe fracture 35 cm long (Figs. 7–12).

At various times during these conservation attempts, areas of the boards had been crudely thinned, particularly where the large butterflies were inserted. Otherwise, the boards retained their original thickness, varying between 6 mm and 10 mm, with consequent steps of up to 4 mm at the joins. When the panel arrived for treatment, it showed signs of being highly stressed. When viewed from the front, it was concave, and some fractures were held open, indicating severe tension.

Before any structural work could be carried out, the panel was first kept in an environmental enclosure at 75% RH. When equilibrated, its profile indicated that much of the high stress was relieved. The battens, along with twenty-eight small butterfly cleats and five large ones, were then removed so that rejoins could be made. The recesses from which the

Figure 7

Alexander Keirincx and Roelant Savery, *Death of Orpheus*, seventeenth century. Oil on oak panel, 1.4 × 2.03 m. Private collection, Northumberland. View before cleaning and restoration, showing disjoints and fractures.



Figure 8

Keirincx-Savery, *Death of Orpheus*. The reverse before panel work.

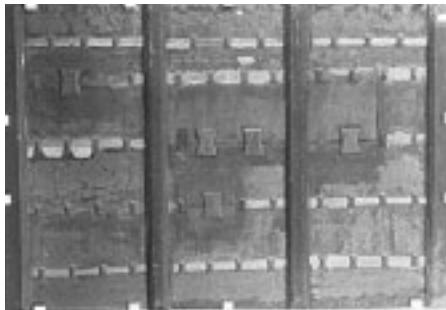

Figure 9

Keirincx-Savery, *Death of Orpheus*. This detail before cleaning and restoration shows a recent fracture in the bottom board.



Figure 10

Keirincx-Savery, *Death of Orpheus*. Detail of the reverse before panel work, showing the end of a batten that had been reglued to the panel, a procedure that caused the fracture shown in Figure 9.

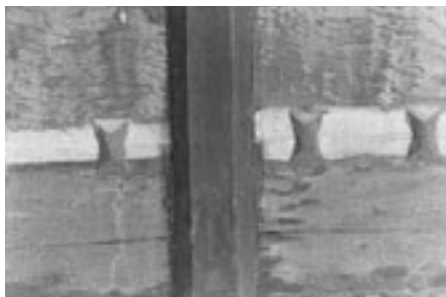
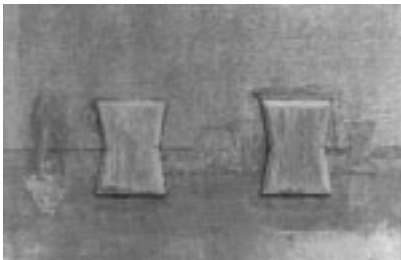

Figure 11

Keirincx-Savery, *Death of Orpheus*. Detail before cleaning and restoration, showing a board disjoin, with two lines of fractures below caused by small and large butterfly cleats.

*Figure 12*

Keirincx-Savery, *Death of Orpheus*. Detail of the reverse before panel work, showing the cleats that caused the fractures shown in Figure 11.

cleats were removed were subsequently filled with shaped oak sections with their grain in the same direction as that of the panel. Other butterfly cleats that did not require removal were planed down flush with the panel's surface.

Difficulties of attaching a support to an irregular surface

After completion of all necessary structural repairs, the panel still presented a formidable combination of problems. There were many faults and lines of weakness. The panel was large and heavy, weighing more than 30 kg, but in some places it was very thin and its surface totally irregular. It was essential to provide reinforcement and to restrain the rapid response to variations in RH by warping, to which the panel was now prone (Fig. 13). To function properly, the secondary support would have to be in close contact with the panel surface.

One of the fundamental principles of the support design is that the calculated flexibility of the battens should not vary from one to

Figure 13

Keirincx-Savery, *Death of Orpheus*. The reverse after structural conservation.

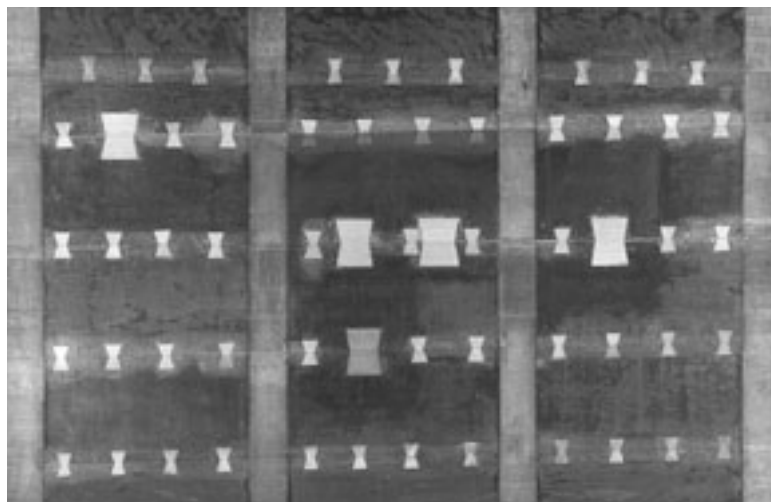

another. This could not be achieved if the battens were individually shaped to the surface irregularities of the panel, a process that would create areas of rigidity and weakness in the battens. Initially, therefore, they were made identical—of uniform thickness and with a flexibility calculated to provide reinforcement. Calculations were made on the basis of using ten flexible battens, and it was decided to use one retaining strip on each of the six boards. Sitka spruce was again chosen as the most suitable timber from which to make the lattice.

With the layout for the main elements of the lattice decided, the panel was then laid facedown on a horizontal surface with support to maintain its camber established at 55% RH. The prepared battens were laid across it at the chosen spacing and weighted to deflect into contact with the concave back surface of the panel. With the top surface of the highest batten as a datum, the others were raised to the same level using suitable packers.

When all of the battens conformed to a uniform curved plane, the retaining strips were laid across the battens at the designated spacing. The retaining blocks, which had been prepared oversized (in terms of height), with slots already cut, were reduced in height and their bases shaped to suit the position in which they would be glued to the panel, with the slots aligned to engage on the retaining strips. This was a tedious process involving 132 blocks, but it was important that it be done accurately so as to ensure that the retaining strips would slide freely into place.

The packers supporting the battens were removed and replaced with a balsa thickening layer glued cross-grain to the underside of each batten. This layer was shaped to the surface profile of the panel. When completed, the addition of the balsa was found to have no measurable effect on the comparative flexibility of the battens. The battens were now all engaged by the retaining strips with a reasonably consistent contact over the irregularities of the panel surface.

To complete the support, the battens were linked together with two supporting strips to form a lattice, and an angle section of timber was produced to act as a support for the weak bottom edge of the panel. This angle was glued and doweled to the tips of the lattice, with bamboo pins cut from swab sticks as dowels.

Framing and retention

Now that there was an even surface alignment of the battens, the production and mounting of back springs was quite straightforward. The springs consisted of flexible bridging strips mounted centrally on each batten with Plastazote-foam-cored timber pads. The space available gave the springs a span of more than one-quarter of the batten length.¹¹ The use of pressure pads was unnecessary, as it was proposed to use a retaining bar that could bear directly against the bridging strips (Fig. 14).

With the auxiliary support engaged, the panel's restrained warp was monitored until stabilized at 55% RH, and the edge profiles of the panel were then recorded. A slip addition for the frame rabbet was made to follow the panel's profiles. Alterations were also made at the back of the frame to build up the rabbet. These alterations provided greater depth to accommodate possible increased curvature in the panel and support assembly of up to 30 mm.

Figure 14

Keirincx-Savery, *Death of Orpheus*, reverse. The retaining blocks are glued in place; the flexible auxiliary support is engaged.

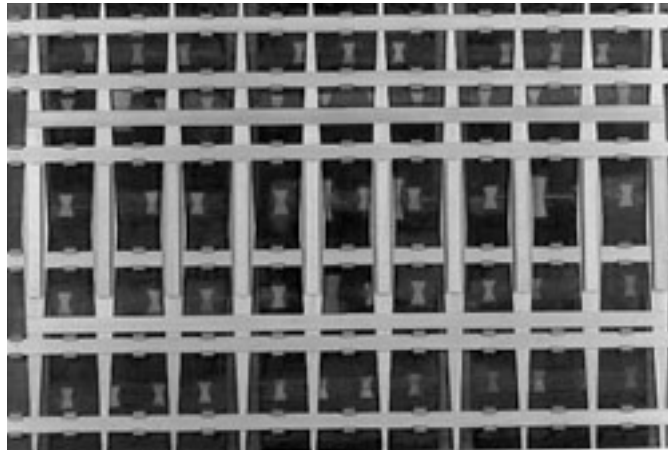
*Figure 15*

Keirincx-Savery, *Death of Orpheus*, reverse. The completed panel/support assembly is shown mounted in the frame, with the retaining bar in place.

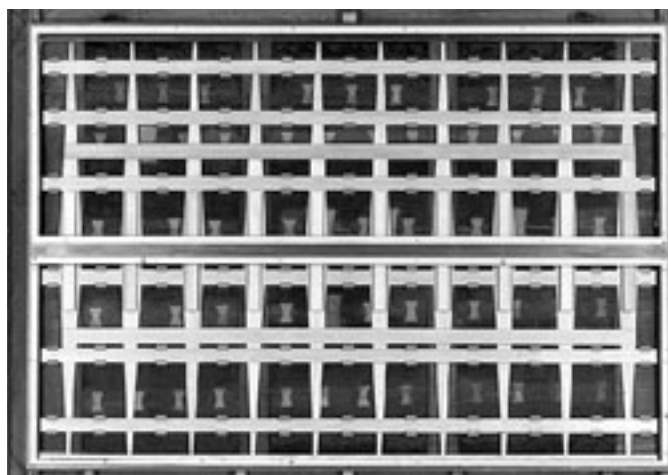

A rigid timber beam, 100 × 30 mm in section, was then used across the back of the frame as a retaining bar to hold the panel/support assembly in place (Fig. 15).

Finally, the back of the frame was totally enclosed with two thin plywood sheets as backboard sections, fitted above and below the retaining bar. The backboards may be removed to allow inspection of the retained assembly without its being disturbed in any way.

An advantage of using this type of auxiliary support system is that it is one of the least intrusive methods of tackling problems such as those presented by the Keirincx-Savery panel. Most of the remaining original surface features have been preserved, and if at any time there is a suspicion that further problems are arising, conservators can gain access quickly and easily by removing the lattice, leaving only the retaining blocks attached to the panel. By themselves, these blocks are unlikely to have an adverse effect on the panel and do not preclude the possibility of further conservation work being carried out, after which the lattice could again be easily replaced.

Reducing friction on the supporting edge of heavy panels

When the panel work was completed, there still remained a framing difficulty to overcome. The Keirincx-Savery highlighted this recurrent problem of displaying large, heavy, horizontal-grain panels.

Even with the achievement of a flexible auxiliary support that will allow changes of curvature (although partially restrained) to occur in a panel, the whole object of the exercise will be defeated if the panel's supporting edge gets stuck and cannot move smoothly in the frame rabbet. With lightweight panels it has been common practice to use Teflon/PTFE pressure-sensitive adhesive tape to line the tray or frame rabbet, thus reducing friction against the load-bearing edge of the panel. With large, heavy panels, the reduction in frictional resistance achieved by Teflon tape may only be sufficient to prevent total jamming. Movement of the panel's bottom edge is still likely to be erratic, however, with sudden jumps occurring only when the warping stresses build up in the panel and exceed the frictional resistance imposed by its weight. Also, it is not uncommon to find environmentally responsive panels that have warped away from a slip profile and have become wedged at the back of the frame rabbet.

A solution to this problem of reducing friction, found suitable for the Keirincx-Savery panel, was simply to mount the bottom supporting edge of the lattice on bearings. Several bearing designs were investigated. Among them, linear slide bearings were found to be available with coefficients of friction as low as 0.003 (i.e., a force of 3 gm will move a 1 kg load on a horizontal surface). These bearings are high-specification devices for engineering applications and as a result are relatively expensive.

For the Keirincx-Savery panel painting, however, the type chosen were simple bearings known as Ball units that were found to work extremely well and are being considered for use on some even larger panels. A possible disadvantage of Ball units is that the minimum dimension below the panel needed to accommodate them is 20 mm, whereas with linear slide bearings it can be as little as 8 mm. Fortunately, the Keirincx-Savery frame was substantial enough for 20 mm deep recesses to be cut for the bearing to run in. Two Ball units were used, giving a combined specified load-bearing capacity of 50 kg. Polished 18-gauge stainless steel blanks were placed in the recesses as a running surface for the bearings. If adequate depth had not been available in the frame, then the thinner, more expensive type of linear slide bearing would have been considered (Figs. 16, 17).

Since completion of the restorations,¹² the Keirincx-Savery panel/support assembly, mounted in its frame, has been monitored at the

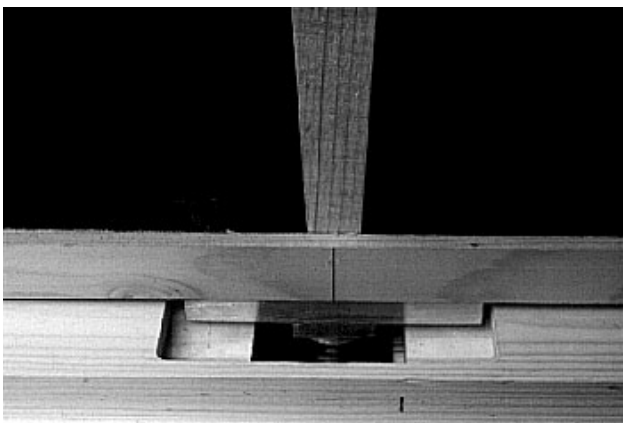

Figure 16
Detail of the vertical support bearing.



Figure 17
The support bearing seen from below.

author's studio. So far, the results of the structural conservation work look very promising. The efforts made to ensure the long-term stability of this panel painting will have likely been worthwhile (Fig. 18a, b).

Summary of the Principles of Calculating Batten Flexibility

When a secondary support is attached to a weak, responsive panel, it fulfills two functions. One is reinforcement, the other is restraint. Restraint is the function that is potentially damaging and also the most difficult to evaluate. It may be defined as the degree of rigidity required to resist the bending force of the panel. If the resistance is too high, the panel may be damaged.

A safe level of resistance could be calculated with basic engineering formulas if the panel's bending force can be found, but this calculation requires a figure for the modulus of elasticity (E value) across the grain of the panel. Approximate E values perpendicular to the grain may be derived from reference tables, but only for sound timber samples. For aged, stress-weakened, or damaged timber, these figures are not relevant and cannot be used. If the panel's strength cannot be estimated, then it is virtually impossible to calculate the rigidity of battens needed for tolerable restraint.

An alternative approach is to consider the problem from the point of view of reinforcement. This assessment can be made with the panel lying horizontally over a central beam, with the battens providing the rigidity necessary to support the panel's weight without it deflecting too far. Calculating reinforcement in this way is relatively easy, and the judgments involved are not too demanding.

In practice, it has been found that a support with a flexibility calculated for reinforcement also provides the safe level of restraint—a level that was difficult to determine by other methods.

If battens, which have been made up to the calculated dimensions with a uniform section, are now tapered in width from the center to the ends, their rigidity will decrease progressively away from the center. The bending force that the panel exerts on the battens also reduces progressively from the center to the outer edges. Therefore, the resistance to bending imposed by the battens on the panel will be balanced, producing an even restraint across the width of the panel. As a result, when the support battens are attached to the panel, the tension on all of the retaining blocks will be more equally distributed than if the battens were left as a uniform section.

The deflection calculated for point loading at the end of the batten will increase by about 50% after the batten is tapered. This increase does not constitute an error in the method of calculation, as it is compensated for by the actual load imposed by the panel's weight being uniformly distributed, so that a corresponding reduction in deflection is produced.

With this method of calculation for batten dimension, the support system has been applied to several panels that varied considerably in size, weight, thickness, and timber type. In all cases, the measurable reduction in curvature after the supports were engaged has been 30% or less. This level of restraint is judged to be below the threshold where damage is likely to be caused.

The support also provides a degree of reinforcement, enabling the panel to support its own weight and to be handled safely and with more confidence.



a

Figure 18a, b
Keirincx-Savery, *Death of Orpheus*. The general view (a) and a detail (b) show the painting's condition after restoration.



b

Conclusion

In general, before making a commitment to a detailed design, the panel conservator must amass all available information. It should be possible to specify the dimensional limits of movement of the panel that will determine tray depth, and so on; this can be done by monitoring movement. More information may be gained from assessing previous damage to the panel and painted surface, as well as from assessing conditions under

which the panel may be kept in the future. Problems could also develop, especially in the ground and paint layers, when unrestricted freedom of response to environmental changes is allowed.

Sometimes the solution to the problems may be a compromise dictated by display requirements. There is little point in designing a microclimate box or a 15 cm deep tray that cannot be accommodated in an original frame or is unacceptable to the client for display purposes.

It is also worthwhile to consider a combination of ideas rather than a single solution. For example, it should be possible either to reduce or to slow down the response of a panel to environmental conditions with a choice of barrier or buffering techniques, and then to combine the chosen technique with a restraint or an auxiliary support. In addition, there is now a wide availability of technology that makes environmental control possible and more cost-effective in buildings where it would not have been considered previously.

It is not easy to generalize or adopt a standard practice when deciding which method to use. Every panel is different, and it would be incorrect to expect that an acceptable answer to one particular problem can be adopted as a principle for general use.

The fashionable answer among some nineteenth-century cradle makers was to thin, flatten, and restrain panel paintings so that they could be displayed like canvases. Today our views are different, and a lot of time is spent removing work that, when executed, was thought to follow the correct approach but that can now be seen to be damaging. To avoid falling into the same trap, today's conservators should adopt an open-minded approach and continually reappraise their methods and learn from their own experience and that of others.

Acknowledgments

It is the author's belief that many conservators might remain isolated from the benefits of an exchange of ideas if the opportunity to meet other specialist conservators were not made available. It is greatly appreciated that institutions such as the Getty Conservation Institute continue to provide these opportunities at an international level. The author would also like to express his appreciation to the British Standards Institute (BSI) for his use of material from a BSI publication.

Notes

- 1 Reference tables of the modulus of elasticity for timbers including Sitka spruce appear in Molesworth 1951:432–35.
- 2 Sitka spruce (*Picea sitchensis*), a softwood imported from Alaska and Russia, having consistent, reliable mechanical properties. It is used for structural framework in some light-aircraft construction (see Keen 1919).
- 3 Reference tables for modulus of elasticity from Molesworth (see n. 1) are given in lb in^{-2} ; they have been converted into n mm^{-2} by multiplying by 0.0068947.
- 4 PVA Evo-Stik wood adhesive is generally the preferred choice for structural work. It is considered to have good long-term stability and flexibility, giving it higher shock resistance than animal glues, which may become brittle with age. Other adhesives used in these case studies were rabbit-skin glue, for replacement of butterfly cleats, and an impact adhesive containing toluene, for bonding Plastazote polyethylene foam to timber.

- 5 If board width is sufficient, it would be preferable to use three rows of slotted retaining blocks per board. This provides the best pattern of restraint against warp of each individual board. With narrow boards where space is sufficient for only one row of blocks, it is better to place them near the center line to avoid creating tension close to the board joints. It is not considered advisable to use the blocks to reinforce or span board joints, a practice that can frequently be seen with fixed-cradle members.
- 6 Teflon/PTFE skived tape, with a pressure-sensitive adhesive coating on one side, has been found to be the best of the range of PTFE products for reducing friction. A cheaper alternative recently found available is polyolefin tape. This is an ultrahigh molecular weight (UHMW) polyethylene material with a coefficient of friction comparable to PTFE. The pressure-sensitive rubber adhesive coating is more suitable for timber, and it also has improved mechanical characteristics, such as lower elongation and higher wear resistance to abrasion. As yet, it has not been in use in the author's studio long enough for full evaluation.
- 7 In the United Kingdom, this means that the panel has been stabilized at 55% RH.
- 8 Plastazote is a closed-cell, cross-linked polyethylene foam available in a number of densities. The one used as a core in the timber mounting pads is the low-density LD24.
- 9 Tables of values of modulus of elasticity of timber relate to data obtained from testing in a direction parallel to the timber grain. Figures do not exist for E values perpendicular to the grain. However, a useful reference can be found in a British Standards Institute (BSI) publication (1991:pt. 2, clause 11 ["Additional Properties"]): "In the absence of specific test data, it is recommended that, for tension perpendicular to the grain, torsional shear and rolling shear, values which are one-third of those parallel to the grain should be used. *For modulus of elasticity perpendicular to the grain, a value of one-twentieth (i.e., 0.05) of the permissible modulus of elasticity should be used*" (emphasis added).
- Properties of Sitka spruce are given in table 11 of the BSI publication. Information for obtaining complete copies of the publication can be found in the "Materials and Suppliers" section below.
- 10 Alexander Keirinx (1600–1652) and Roelant Savery (1576?–1639). The painting depicts Orpheus, who could enchant the beasts, being attacked by the Thracian women.
- 11 A span of not less than one-quarter or more than one-third of the batten length has been found in practice to be a good dimension for which to aim.
- 12 Restoration of the painting was carried out at Lank Sanden Studio in London.

Materials and Suppliers

Ball units, Alwayse Engineering Ltd., Warner Street, Birmingham B12 0JG, England. (Large range of Ball transfer units available; the type in use are from the Solid Body Unit range.)

BSI Publications, BSI Customer Services, 389 Chiswick High Road, London W4 4AL, England.

Evo-Stik, wood adhesive, waterproof, or extra fast resin "W," Evode Ltd., Common Road, Stafford, England.

Linear-motion slide bearings, SKF Engineering Products Ltd., 2 Tanners Drive, Blakelands, Milton Keynes, MK14 5BN. (Small units are available in the standard slide range, RM series.)

Plastazote (a closed-cell, cross-linked polyethylene foam, REF LD 24), BXL Plastics Ltd., Mitcham Road, Croydon, Surrey CR9 3AL, England. (Distributed by Hemisphere Rubber Co., 65 Fairview Road, Norbury, London SW16 5PX, England.)

Polyolefin ultrahigh molecular weight (UHMW) polyethylene tape with a pressure-sensitive rubber adhesive (marketed as Polycohr), CHR Industries, Inc., 407 East Street, New Haven, CT 06509. (The European supplier is Furon CHR Products, P.O. Box 124, 7640 AC Wierden, Netherlands. Distributed in the United Kingdom by Polypenco Ltd., now part of DSM Engineering Plastic Products UK Ltd., 83 Bridge Road East, Welwyn Garden City, Hertfordshire AL7 1LA, England.)

Teflon/PTFE (polytetrafluoroethylene) tape with a pressure-sensitive silicon adhesive (marketed as Temp-r-tape HM series), CHR Industries (see information for polyolefin tape).

References

- 1991 **British Standards Institute**
Publication no. BS5268. London: BSI.
- 1984 **Brough, J., and J. Dunkerton**
The construction of panel trays for two paintings by the Master of Capenberg.
National Gallery Technical Bulletin 8:63–70.
- 1919 **Keen, G. R.**
Aeroplane Timbers: Their Structural Formation and Mechanical and Commercial Properties.
London: Rider and Sons.
- 1951 **Molesworth, G. L.**
Molesworth's Handbook of Engineering Formulae and Data. 34th ed. London:
E. and F. N. Spon.
- 1978 **Thomson, G.**
The Museum Environment. London: Butterworths.

Structural Conservation of Panel Paintings at the National Gallery, London

Anthony M. Reeve

THE NATIONAL GALLERY, LONDON, has a comprehensive collection of western European paintings from the thirteenth to the twentieth century. There are some one thousand panels in the collection, more than half of which are Italian and painted on poplar. The other main schools—Dutch, Flemish, and German—usually used oak. Other woods used include lime and beech (used by Lucas Cranach the Elder, for example), walnut or fruitwood (pear), and pine.

The National Gallery has mostly conventional panel structures of different types of wood with members glued together, mostly with animal glues, and usually with the grain running in the same direction as the joins. There are also some complex structures, of which Rubens's panels, such as *A View of Het Steen* (NG66) and *The Watering Place* (NG 4815), are prime examples (Brown, Reeve, and Wyld 1982) (Fig. 1).

Most of these panels have undergone some form of conservation work, ranging from crack repair to added buttons, battens, and cradles, or thinning and transfers. For the most part this work has been carried out prior to or at the time of acquisition by restorers abroad and in England.

Figure 1

X ray of Peter Paul Rubens, *The Watering Place*, 1615–22. Oil (identified) on panel, 99.4 × 135 cm. National Gallery, London (NG 4815). The eleven panel members, as well as the buttons and battens, are seen before conservation treatment.

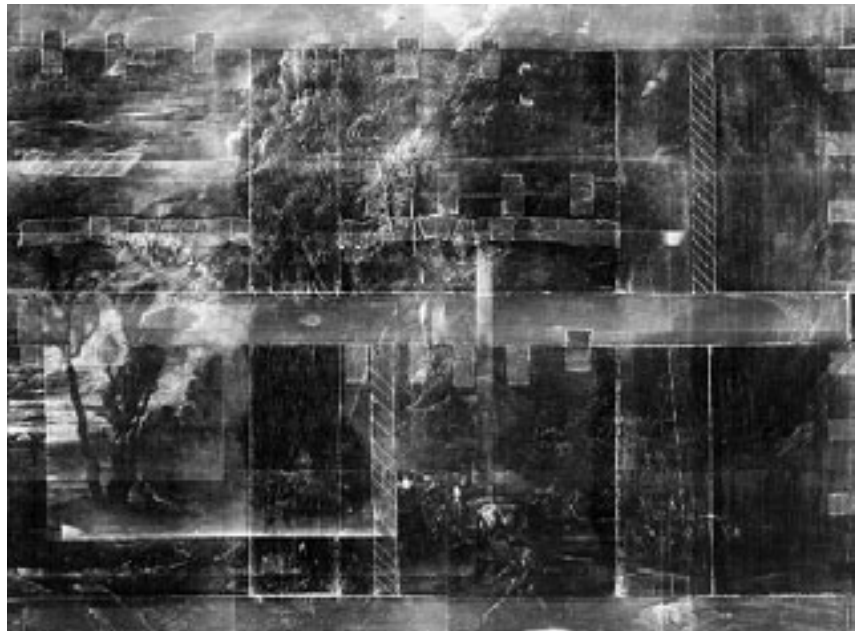

The National Gallery's Conservation Department, founded in 1946, initially occupied two converted exhibition rooms. Restoration studios built specifically for this purpose were opened in 1959. In theory, in-house restorers have carried out all the work on the collection since 1946. In practice, the records show that during the early years, there was still considerable structural work carried out by private restorers (Morrill is the most often mentioned). In 1949 (as described below in connection with balsa-wood buildup), Richard Buck came to the gallery from the United States with new ideas on panel work and transfer. In 1965 the gallery was still inclined to the removal of original wood, believing it would minimize the possibility of further movement; complete transfer was sometimes considered. Treatments of various kinds have been developed over the years, progressing to the present day. In looking back, one can see that some of the conservation treatments may not have been the most effective, although they were accepted practice at the time. The author has supervised all the structural treatments in the department since 1977.

This article contains a description of the methods used in the National Gallery at present. Where relevant, old methods and materials are discussed. As a general rule, every part of the original support is preserved whenever possible. Necessary treatments are designed to be as easily reversible as possible. Old methods and materials of conservation are not changed unless new ones can be shown to be more satisfactory.

The best environment for panels is considered to be 55% relative humidity (RH) at 21 °C; it is preferable to err on the side of higher, rather than lower, humidity. It is best never to move panels from these conditions if possible. The transport of panels from one country to another by aircraft and the exposure to a different, usually drier, environment have been prime causes of much panel movement and subsequent deterioration. Deterioration is even more pronounced if restrictive conservation has been carried out first. The location (e.g., church, country house, museum) of a panel greatly influences the types of treatment and materials necessary to carry out the best conservation.

Present Conservation Methods

Animal infestation

Any suspicion of worm or beetle activity should be treated to prepare the individual object for conservation, as well as to protect other objects from infestation. Various forms of treatment (gassing, oxygen deprivation, or liquid application) are suitable for particular problems.

Surface consolidation

Sturgeon glue, normally diluted to an approximately 5% solution, is commonly used with controlled-heat spatulas for conserving loose or blistered areas. If this proves unsuccessful, one may have to use a different adhesive to secure old flaking or impregnations. After surface consolidation of a painting that has previously been restored, it is usually preferable, where possible, to clean the painting to remove excessive fillings that might impede structural consolidation. Surfaces can often be improved where an old conservation treatment was not totally satisfactory.

Facing of the surface before structural consolidation work

Panels once consolidated on the surface are usually faced before any other treatment is carried out. Crack or join repairs are usually faced up to their edges. The facing should cover the surface entirely if structural or removal work is to be carried out on the back. The rationale for choosing a particular facing material and facing mixture depends on the surface, solubility, and condition of the painted layer and also on the structural work to be carried out. The materials commonly used include Eltoline tissue with Paraloid B72 or B67, or damar with a little wax. Occasionally, aqueous facing adhesives are used, but usually only for transfer treatment. If more than one facing has been applied and it is necessary to release or remove one or more of the facings, then the later layers should have different adhesives to ensure that the picture will always be protected. Where there are open cracks to treat, and protection is necessary, B72 or B67 is normally used first.

Removal of old nails or fixings and the treatment of cracks and joins

If normal methods of removing old nails or fixings are not adequate, heating the metal (which causes expansion and the ensuing contraction) may help.

Having used traditional clamping tools and experienced their limitations, the author designed a clamping table, which was manufactured by Willards of Chichester (Reeve 1990) (Fig. 2).¹

The adhesive generally chosen for joining cracks is Cascamite, a powdered urea-diformaldehyde synthetic resin with a hardener. Its advantages are that it produces bonds that perform well when exposed to extreme dryness or dampness, or even when completely saturated in water. The aqueous quality of Cascamite allows softening and slight expansion of the edges of wood being joined. It also has the possibility of being used in dilute form for penetrating small closed cracks, or in thicker

Figure 2
Clamping table for panel conservation.

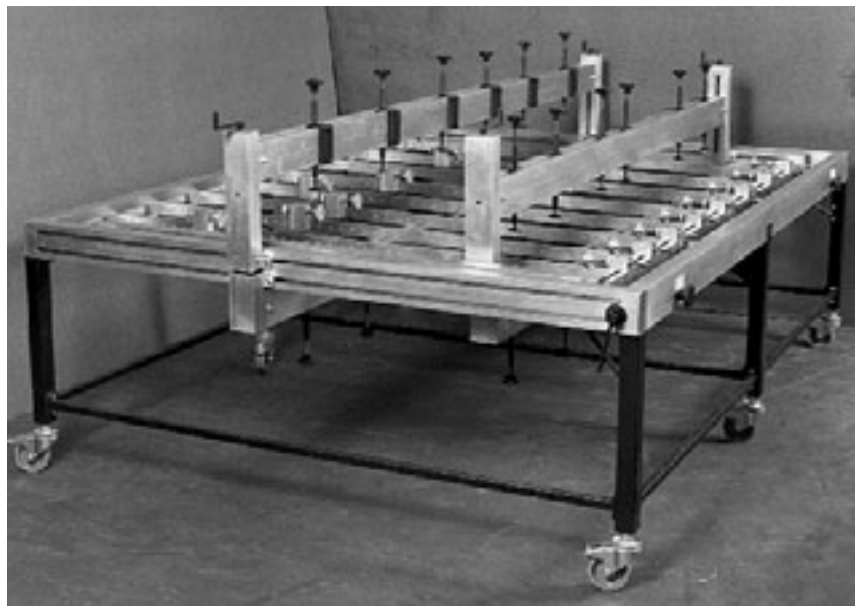

concentration for open joints and wider cracks. If the cracks are over a few millimeters wide, rye flour can be added as a filler; if necessary, polyvinyl acetate (PVA) dispersions can also be used to reduce the brittleness. A wetting agent such as Oxgall can also improve adhesion when permeation is not sufficient. Cascamite has a two-hour or longer working time, making it very useful for working with the final alignment of deformations.

Cascamite is quite a brittle adhesive, although it is adequate to cope with the natural movements of a panel if joined and used properly. Subsequent applications are possible in inaccessible areas, so should difficulties arise, it will rebond very well. Also, changes in RH should not produce the same magnitude of dimensional change that proteinaceous glues undergo, and it is not susceptible to attack by microorganisms.

Where possible, Cascamite is applied to both sides of the join. If the join is partially sealed or only slightly open, the adhesive is applied along the join back and front alternately, and the panel is flexed sideways or up and down as much as the structure will allow without causing further cracking. This action creates an absorption of the adhesive and expulsion of the air. A dabbing movement on the surface can also be effective.

In some cases it may be necessary to use another adhesive. PVA dispersion emulsion (Resin W) is occasionally used; however, it is less easy to work with than Cascamite, as it has a rather short drying time of ten to fifteen minutes. The National Gallery's Scientific Department frequently reviews new materials in search of alternatives. For larger cracks, wood (preferably of similar age and type) may be inserted, with the grain running with the original.

A variant of a widely practiced method used initially for trying to correct warping and then for reinforcing cracks was used at the gallery for a while in the late 1950s and early 1960s. A V-shaped router was made and set to the desired depth to cut a groove along the line of the crack at the back of the panel, removing the original wood. Another tool was then used to produce a V-shaped wedge to fit into the newly cut channel, either in long straight strips or in short strips if the cracks were irregular. The idea usually behind this was to penetrate through to the back of the ground and to produce two new side surfaces to bond to the V-shaped wedge; this method is no longer used, however. In accordance with the ideal of preserving as much of the original wood as possible, cracks are joined edge to edge whenever feasible.

Cases involving insect attack or dry rot may require the removal of the original wood to consolidate the panel; however, this procedure has rarely been necessary on artworks in the National Gallery collection.

Moisture treatments

After crack consolidation or release from previous restrictions (for example, removal of battens or a cradle), a panel may adopt a greater concave or convex warp. It may be possible to reduce the warp by exposure to moisture and relaxation under varying pressure over a period of days or weeks. The low-pressure conservation table, using circulated moisture under a controlled vacuum, is becoming an alternative for this treatment (Reeve 1984; Reeve, Ackroyd, and Wright 1988) (Fig. 3). This table and its use are described in more detail below, in the account of the panel treatment for *Cosmè Tura's Annunciation*.



Figure 3
Multipurpose low-pressure conservation table with small warped test panel during moisture treatment.

Consolidation and impregnation of woodworm-affected areas

Where there are cases of woodworm attack, it is very difficult to consolidate the remaining wood, especially immediately behind the paint. The worst cases of this may eventually lead to the necessity for a transfer. Various materials have been tried in impregnation tests and evaluated for their efficacy in penetration and consolidation, with Paraloid B67 in white spirit found to be the most suitable. This material also could and would act as a moisture barrier, in preference to the old methods of applying Saran or hot wax. B67 and wood flour are used for infills of any large open wormholes or lost areas. Very large losses would possibly be infilled with wood similar to the original, with the grain running in the same direction as that of the original.

Moisture barriers

To create a moisture barrier by means other than impregnation with Paraloid B67 (for example), a layer of material preimpregnated with Beva 371 could be attached to the back of the panel with a warm spatula. This technique can also give extra support to the panel, reducing the need for further treatment.

Infills of balsa wood

Where it proves necessary to remove restricting bars, battens, butterfly buttons, cradles, and so forth from the back of the panel, it is customary to infill with a material such as balsa wood (Fig. 4), cut to half its depth across the grain at 2.5 cm intervals to counter any tendency of its own to move, and usually running parallel with the grain of the original. Sometimes original chamfered sliding battens can be reduced a little, also cut halfway through at 2.5 cm intervals, and reused.

Panel trays

Where the original panel is in a state too fragile to support itself, either because of thinning or because of inherent weakness, it is often incorporated into a tray. The tray is a secondary support that has been used in the National Gallery for a long time, although its construction and materials have been improved and developed in recent years.

The panel tray consists of a backboard made up of Aerolam "F" board (aluminum honeycomb covered in a resinated fiberglass) with the internal edges cut back to allow the inset of a cedar strip (Brough and Dunkerton 1984; Dunkerton and Smith 1986), the purpose of which is to attach the panel tray to the outer oak frame, which is made to cap the front edges of the picture (Fig. 5). In a tray, the picture is completely supported at the back on blocks (minimum 6 mm thickness) of either Evazote (low-density polyethylene [LDPE] copolymer foam) or Plastazote (LDPE foam), with at least 3 mm of the same material under the oak strip that caps the sides and the edges. Evazote and Plastazote are available in different densities, and the strip of Evazote or Plastazote at the bottom of the tray frame supporting the picture should be of a higher density to prevent it from slipping down in the tray's rabbet.

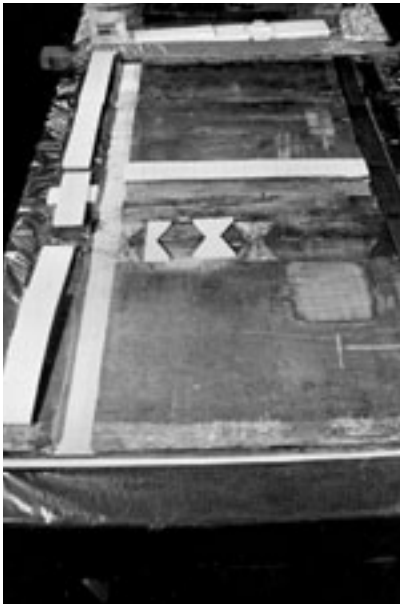

Figure 4
Zanobi di Benedetto Strozzi, *The Annunciation*, ca. 1450. Reverse. Tempera on panel, cut on all sides, 103.5 × 141.6 cm. National Gallery (NG 1406), London. On the back of the panel, infills of toned balsa are seen on the right side; balsa pieces ready for fitting are on the middle and the left side.

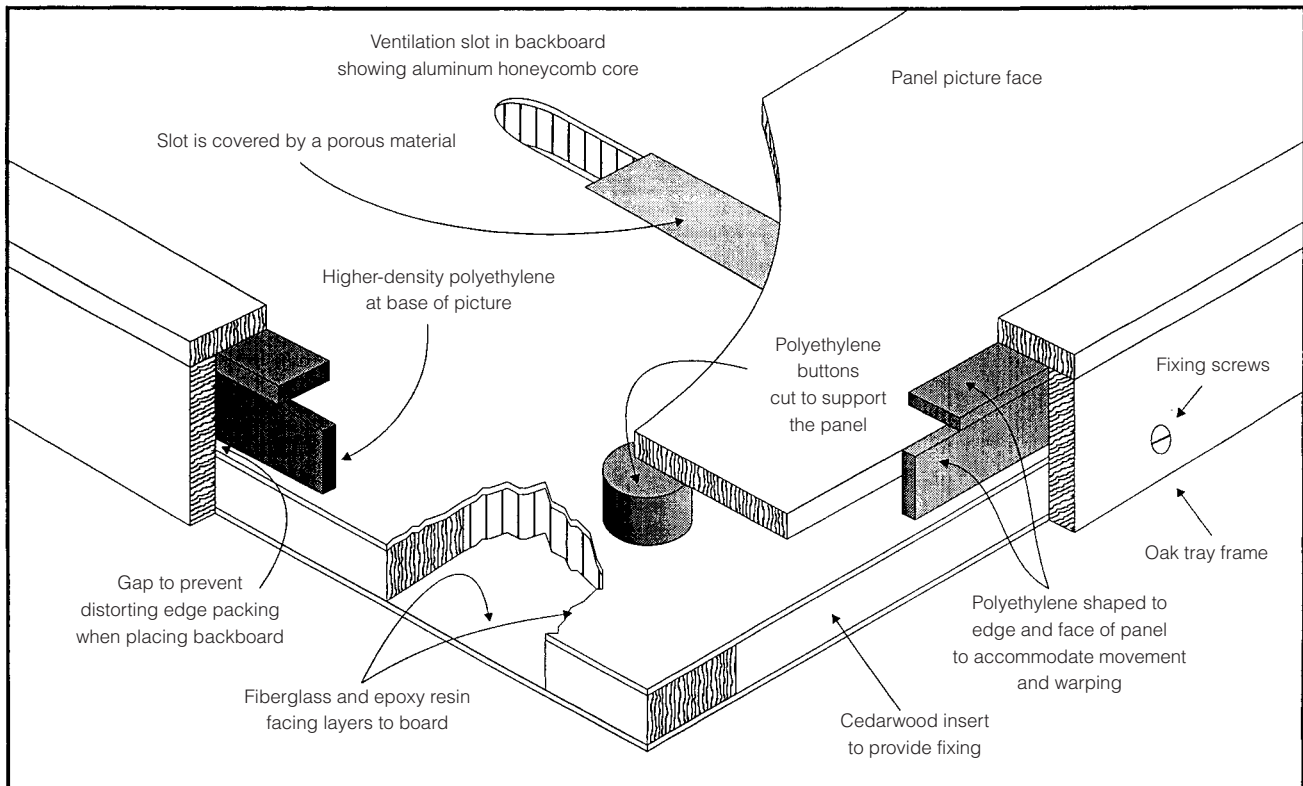

Figure 5
Construction elements of a panel tray.

The Evazote/Plastazote is shaped to accommodate potential panel warp. Only minimal rows of the foam blocks are used, to allow flexing of the panel during environmental changes. This, of course, may happen not only at the edges but anywhere across the width or length of the panel, depending on its structure: restriction of movement is kept to a minimum by this means.

The tray acts as a very substantial protection to a fragile panel, both in its frame and during handling. If the environments are expected to vary, slots can be cut in the tray backboard to allow greater freedom of air movement and to reduce the possibility of concave warp from the front. These slots should be covered with a porous material such as polyester net. However, it is essential to have enough movement available for the panel in the tray through use of blocks and edge slips that are sufficiently flexible. These trays can usually be accommodated in the original frames with a little adjustment, and the front edge of the tray can be toned or gilded to form the inner rabbet of the frame.

Balsa-wood buildup

Balsa-wood buildup is often necessary when, following the removal of a cradle or other veneered additions, a panel is too thin or weak for a tray. The most commonly cradled panels are on poplar and are often thinned to less than a third of their original thickness.

After a panel is released from a cradle and the cracks are consolidated, it usually adopts a convex warp when seen from the front and may also be too thin or too big to maintain a flat or near-flat conformation. After moisture treatment where required, it may prove necessary to attach

a secondary support to the back, which will normally return the panel to its original thickness or even make it slightly thicker.

This procedure used to involve an updated and improved form of a method—the balsa-wood and wax-resin cement buildup—introduced from the United States by Richard Buck in 1949. This method has been described in the *National Gallery Technical Bulletin* (Smith, Reeve, and Ashok 1981) (Fig. 6). Since then, the method has been improved by the use of a different materials as an interleaf—impregnated with Beva 371 on both sides—between the original panel and the buildup, thereby preventing impregnation of the wax-resin into the original panel. Also, the balsa planks are all sawed halfway through at 2.5 cm intervals after the application of each layer, in order to reduce their strength (Fig. 7).

The application of the modified version of a balsa-wood panel buildup begins after moisture treatment or flattening, where necessary. New refinements of the method using the multipurpose low-pressure table are described in the case study below.

Transfers

Transferring a painting is the last resort and is considered only when the support or ground is no longer able to maintain the painting. Methods vary according to the problem. The only example carried out at the National Gallery in recent years was the transfer of *The Incredulity of Saint Thomas* (NG 816) by Cima da Conegliano (1459–1517), in which the following procedure was employed (Wyld and Dunkerton 1985).

After removal of the remaining wood and consolidation of the ground from the back, a reversible isolating layer of acrylic primer was applied, followed by a vinyl emulsion filler. An interleaf of finely woven white linen stretched on a loom was coated on both sides with a synthetic, heat-bonded adhesive (Beva 371) and attached to the reverse of the paint and ground. This was, in turn, attached to an aluminum honeycomb epoxy-coated fiberglass board (Aerolam “F” board), also coated with Beva 371. The author has found it more aesthetically pleasing to use a slightly textured surface for these supports; a flat texture seems to impose an unnatural smoothness.

Panel fittings

For support, early panels or fragments may need specially designed brackets of metal or other material, lined with polyethylene foam or velvet, so that no fixings are applied into the original panel. The security of the object must also be a consideration in the design of the brackets.

Frame fitting and exhibiting

A picture should be put into the frame against a soft surface of velvet or similar material to prevent scuffing of the edges. Panels that are warped need shaped polyethylene foam strips between them and the rabbet. In order for the foam strips not to become compressed at the base of the panels, they must be made of a higher density polyethylene or of balsa wood. Panels should be held in frames with as few fittings as possible, with adequate flexible polyethylene pads between the fittings and the panel. The fittings should also be placed at the ends of the wood grain only—at the top and bottom for vertical grains and at the sides for horizontal

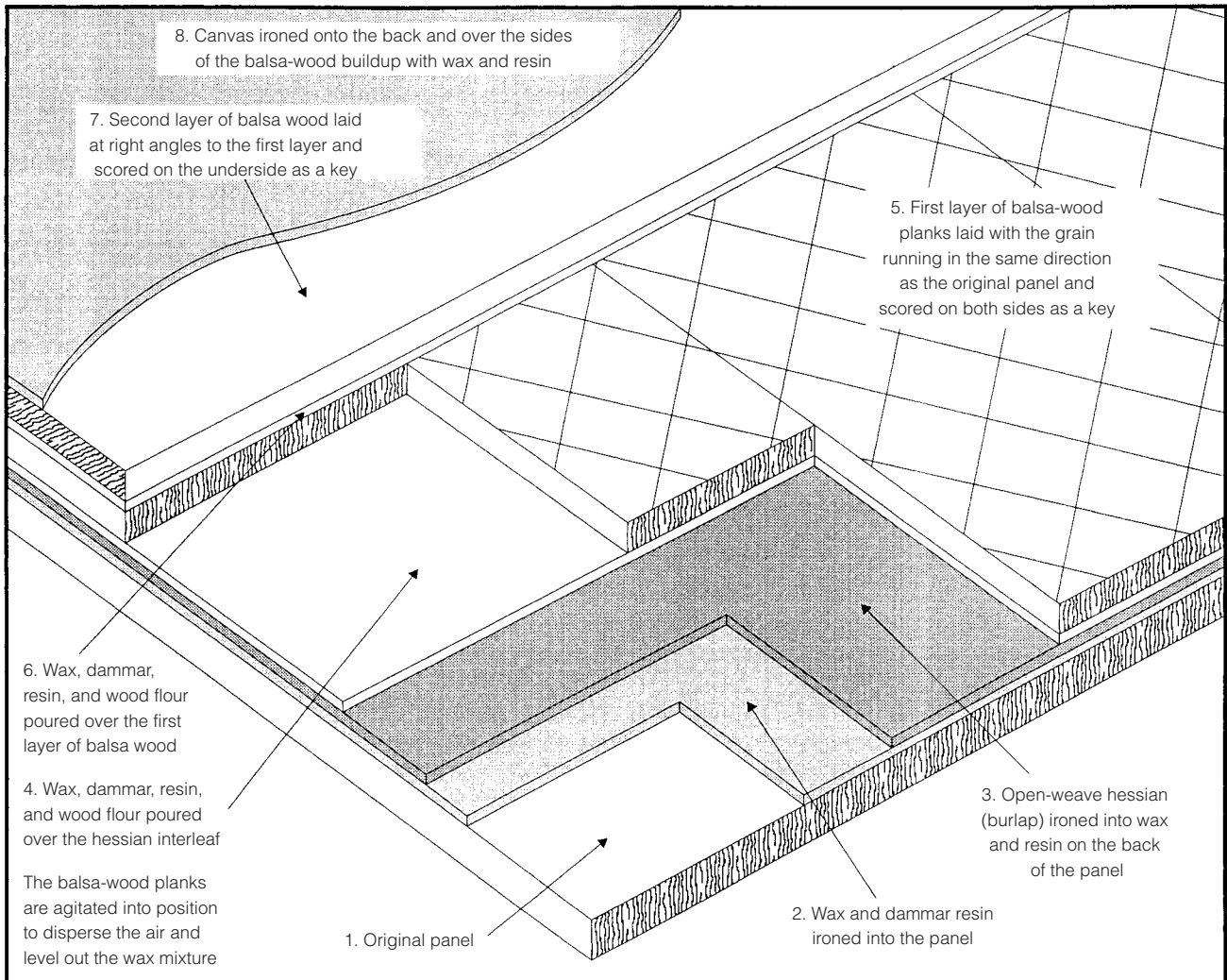

Figure 6
Diagram of the old method of balsa-wood buildup.

grains—and toward the center of the panel. The back of the frame should always project beyond the picture to prevent the panel from pressing directly against the wall. Also, a backboard of some sort helps to act as an environmental buffer and to prevent accidental damage.

When the panels are housed in an uncontrolled or fluctuating environment, it may be necessary to incorporate the panel and/or panel and frame—whether in a tray or not—into a vitrine (to assist in reducing the fluctuation of temperature and RH between the panel and surrounding air) or into a climate-controlled exhibition case.

Case Study: Treatment of a Painting by Cosmè Tura

This small (45 × 34 cm) panel is a fragment of the *Annunciation* by Cosmè Tura (1431–95), probably painted around 1480. The picture is on a poplar panel painted up to the edges and clearly cut all around. It was acquired by the National Gallery in 1874 and recorded to be in good condition. In 1915 the old parquet (cradle) was removed, and the breaks were reset (through the head in a vertical line and elsewhere). The panel was then veneered, and a new parquet was applied. In 1991 the picture was proposed for cleaning and restoration, procedures that were carried out by Jill Dunkerton. The structural work was done by the author and David Thomas.²

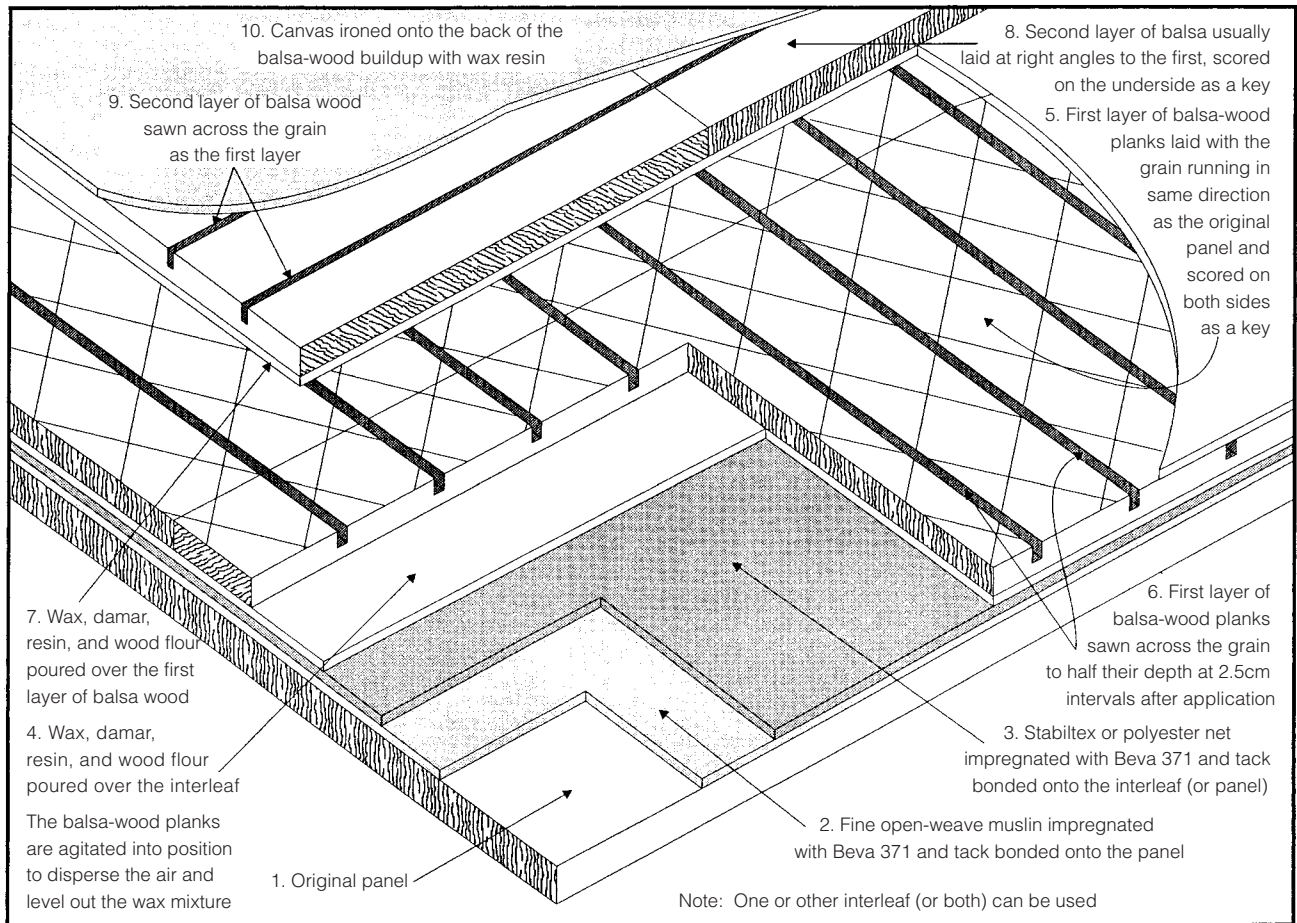

Figure 7
Diagram of the new method of balsa-wood buildup.

Photographic examination by infrared and X ray was carried out to estimate the true condition of the remaining panel and paint (Fig. 8). Infrared photography showed that there was extensive restoration down the off-center vertical crack or join that runs vertically through the Virgin's face, as well as on some other, smaller areas of damage. The X ray showed a very worm-eaten panel, in which most worm channels seemed to have been filled with chalk, glue, and pigment. There were also several insets of a different wood in the complex vertical crack at the top and bottom edges. The original panel had been planed down to a thickness of no more than 2 mm. It was surrounded by thin oak strips, veneered onto mahogany, and cradled with oak sliding bars and mahogany fixed battens. The cradle had caused a slight concave warp on the length of the panel.

The painting's poor condition had been exacerbated by these past treatments, which were causing further cracking, blistering, and flaking. The painting was also covered with a very discolored varnish. Restorations covered original paint in some areas, and the surface was shown to be very uneven under raking light. In order to improve these panel defects, extensive panel treatment was proposed, involving the removal of all later additions.

After cleaning, the wooden inserts could clearly be seen from the front (Fig. 9). Under raking light, it was also clear how badly the surface had been affected, especially in the Virgin's face. Before facing, a tracing was made of all the major cracks and problem areas for future reference, as well as to relate the work to the back of the panel.

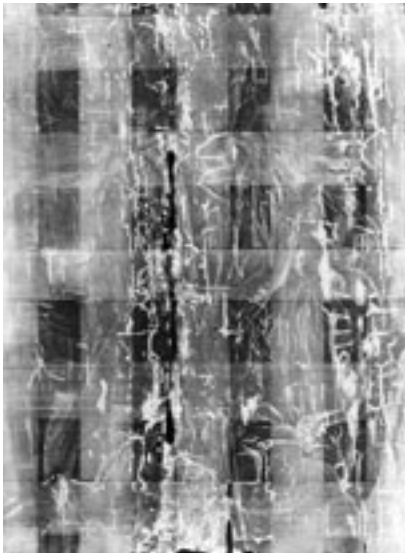

Figure 8, above
X ray before treatment of Cosmè Tura, *The Virgin*. Fragment of the *Annunciation*, 1475–80. Oil and egg (identified) on panel, 45.1 × 34 cm. National Gallery (NG 905), London.



Figure 9, right
Cosmè Tura, *The Virgin*. After cleaning and before panel treatment, the painting shows cracks, losses, and wooden infills.



Figure 10
Cosmè Tura, *The Virgin*, reverse. The bottom right corner of the back of the panel shows worm damage exposed after the cradle and mahogany veneer were removed.

First the picture was faced. With the goal of realigning uneven fragments of the picture adjacent to the cracks, different resins were used. The areas of paint 1.25 cm wide on either side of the main split were faced with small pieces of Eltoline tissue and Paraloid B72 in xylene. The pieces were shaped to support and protect the edges of paint along the split and some islands of paint and ground within the split, while allowing the split and other cracks to remain accessible. Two further complete layers of facing were applied over the whole surface with the Paraloid B67 in white spirit. This facing protected the painting during cradle and veneer removal, but when it was necessary to remove some parts during the crack conservation, it could be done without disturbance to the B72 facings.

The mahogany cradle was removed by the procedures of sawing across the glued battens at 2.5 cm intervals and chipping away with a gouge or chisel.

This treatment exposed a mahogany veneer approximately 5 mm thick, which was removed with hand gouges and scalpels. Once the mahogany was removed, the back of the thinned panel could be seen (Fig. 10). Many open cracks in the back of the panel had not been visible from the front. The procedure also exposed the many worm channels, seen in the X ray, that had been filled with pigment. The fillings were removed where necessary to enable realignment and securing of the cracks and old joints. In some areas where the fillings were removed, there was no panel fabric left, and the back of the original gesso was exposed. It is not certain when the picture was thinned: it could have been when the first cradle was applied, or possibly when the panel arrived in England. However, it is thought more likely to have been during the second intervention; during thinning, the panel collapsed in some of the worm-eaten areas, the infills

of wood were applied, and a second orange putty was pushed in from behind around the new inserts next to the older white putty. These were now strengthened with dilute PVA (Vinamul 3252) in dispersion. Realignment of distorted parts was accomplished by softening and reopening some of the old joints and inserts, gradually reweighting, drying, and gluing them into new positions while the picture was placed facedown.

Voids and worm channels were filled with thin layers of Fine Surface Polyfilla—a vinyl ester of Versatic 10 (Shell Resin)—PVA copolymer (Veo Va-PVA) with filler and thickener (Caley 1993). The mahogany insets and oak strips around the edges were left in place as a protection, but those along the top and bottom edges ran against the grain. Those insets were sawed through at 1.25 cm intervals to prevent any restriction. With all of the cracks glued and secured, the panel now took on a convex warp when seen from the front.

Because the panel was exceptionally fragile, it was decided that a balsa-wood buildup was necessary to provide support and stability. The panel was treated with controlled moisture to reduce the warp that had occurred after the removal of the additions and consolidation of the cracks and joints. In a departure from the traditional method of suspending the panel over damp pads, treatment was carried out on the multipurpose, low-pressure conservation table, hitherto used primarily for canvas treatments. The painting was placed faceup on the table and covered with Melinex (known in the United States by the trade name Mylar) (Fig. 11). A very mild surface vacuum was applied, and the table was warmed slightly to 30 °C. Room RH was raised from 55% to 75–80%. The air circulated in the area under and around the panel; humidification continued for about an hour.

The panel relaxed naturally, and as it did so, the surface vacuum was increased accordingly. When the panel had relaxed completely, humidification was turned off, the surface vacuum was maintained, and the excess humidity was drawn away from below with the built-in dehumidifier, bringing RH back to 55% while slowly reducing the temperature of the table to 21 °C. The dehumidifier was kept running at the same setting for several hours. The vacuum was then turned off and the panel left on the table until the next day, where it had flattened considerably, although it still had a slight frontal convex warp.

Figure 11
Cosmè Tura, *The Virgin*. Moisture introduction on the multipurpose low-pressure conservation table.

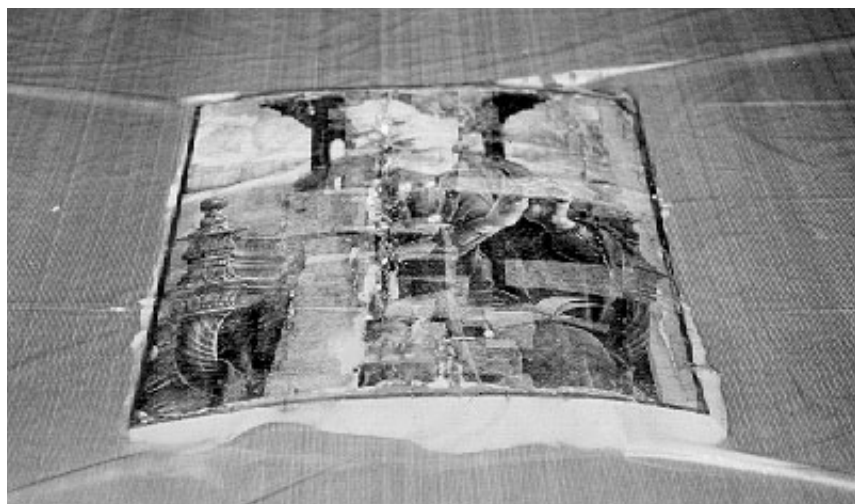

Further moisture treatment from the back was necessary, but a slower, more even drying process was desired. Therefore, moisture was sprayed onto the back with a pressurized fine-spray humidifier, and the panel was placed facedown on a Melinex interleaf. Fine linen canvas and then hessian (burlap) webbing were placed over the back to form a moisture-retention layer as well as an evacuation layer, which allowed a slower drying under a slight vacuum. The procedure, which was continued for a day with the dehumidifier, brought the room RH back to 55% at 21 °C. Afterward the panel showed a flatter plane.

Under raking light the uneven thinning of the original panel showed ripples and distortions. Two suitable interleaf materials were required. After the application of the first interleaf, the undulations in the panel were evened out with a filler and then isolated with a second interleaf before attachment to the balsa-wood buildup. A combination of muslin and then Stabiltex (a very finely woven polyester) was used. Fine muslin was prestretched on a strainer and coated on both sides with three coats of Beva 371. The panel was put facedown on Melinex over thick blotting paper on a board on the low-pressure table, and the strainer with the impregnated muslin was placed over the back. A sheet of silicone Melinex was placed over the Beva-coated area of the panel, the whole was covered in Melinex, and a vacuum was applied.

With a heated spatula, the muslin was then bonded to the back of the panel through the silicone. When it had cooled, the vacuum was released. Now the panel was attached and could be easily handled on the strainer.

During these treatments, the table was usually at about 30 °C; the table's built-in dehumidifier helped maintain the temperature by controlling the RH level. An overall infill of Fine Surface Polyfilla was applied on the back of the hessian webbing and sanded flat when dry.

A coat of Beva 371 was applied over the leveled layer of Polyfilla; a second interleaf was prepared by prestretching Stabiltex on a strainer and applying three coats of Beva 371 on both sides.

The first strainer on which the muslin and panel had been attached was detached. To make sure the painting had adopted a satisfactory surface, it was placed faceup on the board, with webbing under the muslin up to the edges of the panel, and covered with Melinex. A vacuum was then applied and the surface observed: the improvement was marked.

For the application of the Stabiltex layer, the painting was laid facedown on Melinex, and blotting paper and webbing were laid up to the edges of the panel over the visible edges of the muslin. The new strainer with the Stabiltex was laid over the painting; silicone was laid over the panel; and then the whole was covered in Melinex and a vacuum applied. The Stabiltex layer was then attached with a heated spatula.

The picture was then taken off the table and kept on the strainer in preparation for the next step, a balsa-wood buildup. Planks of balsa measuring 12.7 × 63 cm were prepared on the table. In this instance, it was decided to put two layers of balsa running with the grain of the original—as opposed to the normal practice of putting the first with the grain and the second against the grain. This variation was chosen because it was thought to reduce slightly the strength of juxtapositioning, as well as to reduce the chance of any restriction if the panel should move. The balsa wood in this instance was cut across the grain at 2.5 cm intervals to half of its depth, so

Figure 12

Cosmè Tura, *The Virgin*, reverse. Balsa-wood buildup on the multipurpose low-pressure conservation table.

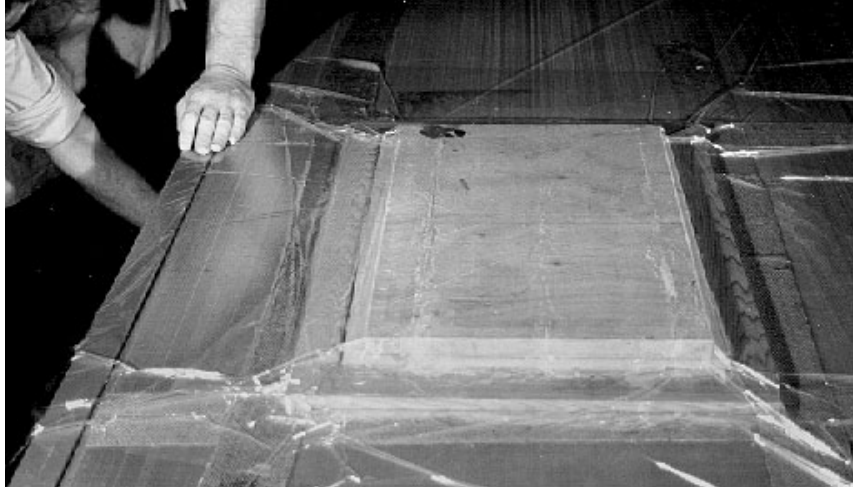

that its strength was reduced before application. Both sides of the first layer and the underside of the second layer were scored to form a good key.

The panel was cut out of the strainer and placed facedown on Melinex and blotting paper. Webbing was then placed up to and around the edges of the original panel. A wooden frame was built up to the combined thickness of the panel plus the first layer of balsa wood. The purpose of this frame was to reduce the vacuum pressure on the edges so that there were no distortions in the even downward pressure on the balsa-wood layer. The heated wax-resin and wood flour cement were applied, and the first layer of prepared balsa wood put on. The second layer was

Figure 13

Cosmè Tura, *The Virgin*, after panel treatment and restoration.



applied immediately afterward. The wooden frame was placed around the edges of the panel; an overall vacuum was then applied and maintained for a few hours (Fig. 12).

The panel was released and the balsa wood trimmed back to the edge of the original. The sides were chamfered slightly and the interleaves turned around and attached by heated spatula to the sides and back. The sides and back were covered with a fine linen canvas attached by ironing with wax-resin, and trimmed back to the facing edges. Seen from the side and end, the panel now has a very slight frontal convex warp. Raking light photographs show a considerable improvement in the surface.

Subsequently, the holes in the picture were filled and the losses restored with Paraloid B72; the picture was then varnished with Larapol K.80 (Fig. 13).

Notes

- 1 The clamping table incorporates longitudinal sash clamps, together with vertical clamping above and below. All clamps can be moved into any position laterally and vertically. The apparatus has proved to be a great aid in the re-forming and rejoining of panels, especially those with complex splits, broken joins, and uneven distortions.
- 2 There is a further reference to the painting in *OPD Restauro* (1992) (Dunkerton 1993).

Materials and Suppliers

Aerolam "F" board, Ciba-Geigy, Duxford, Cambridge, CB2 4QD, England.

Balsa wood, Solarbo Ltd., Commerce Way, Lancing, Sussex, BN15 8TE, England.

Beva 371, Atlantis European Ltd., 146 Brick Lane, London, E1 6RU, England.

Blotting paper (for humidifying), Arcesso Conservation Materials, 194 Blue House Lane, Oxted, Surrey, RH8 ODE, England.

Brackets and mirror plates, Frank B. Scragg and Co., 68 Vittoria Street, Birmingham, B1 3PB, England.

Cascamite (urea-diformaldehyde adhesive and hardener), tool and hardware shops.

Clamps, Buck and Ryan, 101 Tottenham Court Road, London, W1P ODY, England.

Conservation tissue (previously Eltoline, now LX tissue, 100% manila hemp long-fiber tissue), Barcham Green and Co. Ltd., Hayle Mill, Maidstone, Kent, ME 15 6XQ, England.

Evazote, Zotefoams Limited, 675 Mitcham Road, Croydon, Surrey, CR9 3AL, England.

Gator foam, Dixon and Roe Ltd., Units I and II, Bricklayers Arms Estate, Mandela Way, London, SE1 5SP, England.

Gelatin, Thew Arnott and Co. Ltd., Newman Works, 270 London Road, Wallington, Surrey, SM6 7DJ, England.

Larapol K.80, BASF United Kingdom Ltd., Dispersions and Pigments Division, P.O. Box 4, Earl Road, Cheadle Hulme, Cheadle, Cheshire, SK8 6QG, England.

Linen canvas, Ulster Weavers, 47 Linfield Road, Belfast, BT12 5GL, Northern Ireland.

Mastic, damar, and wax, A F Suter and Co. Ltd., Swan Wharf, 60 Dace Road, London, E3 2NQ, England.

Melinex (Mylar), Preservation Equipment Ltd., Church Road, Shelfanger, Diss, Norfolk, IP22 2DG, England.

Multipurpose low-pressure conservation tables, clamping tables for panel conservation, spatulas, and irons, Willard Developments, Industrial Estate, Chichester, Sussex PO19 2TS, England.

Muslin, Russell and Chapple Ltd., 23 Monmouth Street, London, WC2H 9DE, England.

Paraloid B67 and Paraloid B72, Lascaux Restauro, Alois K. Dethelm A.G., CH 83026 Bruttisellen, Switzerland; and Atlantis European Ltd., 146 Brick Lane, London, E1 6RU, England.

Paste glue (pearl glue), Brodie and Middleton Ltd., 68 Drury Lane, London, WC2B 5SP, England.

Plastazote, Zotefoams Limited.

Polyester net, John Lewis Partnership, 278-306 Oxford Street, London W1A, England.

Silicone release paper, Custom Coating and Lamination Group, Worcester, MA 01605.

Stabiltex (polyester multifilament), Plastok Associates Ltd., 79 Market Street, Birkenhead, Wirral, Merseyside, L41 6AN, England.

Sturgeon glue, Preservation Equipment Ltd.

Velvet ribbon, Barnett, Lawson, Trimmings Ltd., 16-17 Little Portland Street, London, W1N 5DE, England.

Vinamul 3252 (vinyl ethylene copolymer) dispersion, Atlantis European Ltd., 146 Brick Lane, London, E1 6RU, England.

References

- Brough, J., and J. Dunkerton
1984 The construction of panel trays for two paintings by the Master of Capenberg. *National Gallery Technical Bulletin* 8:63-70.
- Brown, C., A. M. Reeve, and M. Wyld
1982 Rubens's "The Watering Place." *National Gallery Technical Bulletin* 6:27-39.
- Caley, T.
1993 A note on Polyfilla. *Picture Restorer* 4 (autumn).
- Dunkerton, J.
1993 "La Vergine Annunciata" di Cosmè Tura in "Il restauro dei dipinti su tela e tavola: Problemi ed esperienza." Atti della giornata di studio in occasione dei sessanta anni del Laboratorio Fiorentino di Restauro dei Dipinti, Firenze, 18 dicembre 1992. *OPD Restauro* 5:16-22, 65-66.
- Dunkerton, J., and A. Smith
1986 Ercole de Robertis's "The Last Supper." *National Gallery Technical Bulletin* 10:33-37.
- Reeve, A.M.
1984 A new multipurpose low pressure conservation table for the treatment of paintings. *Studies in Conservation* 29:124-28.
1990 A new multi-purpose clamping table for the treatment of paintings on wood. *Studies in Conservation* 35:160-62.
- Reeve, A. M., P. Ackroyd, and A. Stephenson Wright
1988 The multi-purpose low pressure conservation table. *National Gallery Technical Bulletin* 12:4-15.
- Smith, A., A. M. Reeve, and A. Ashok
1981 Francesco del Cossa's "S Vincent Ferrer." *National Gallery Technical Bulletin* 5:45-57.
- Wyld, M., and J. Dunkerton
1985 The transfer of China's "The Incredulity of S. Thomas." *National Gallery Technical Bulletin* 9:38-59.

Some Rejoining Methods for Panel Paintings

Al Brewer

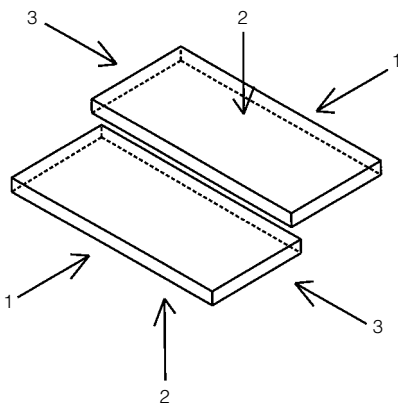

Figure 1
General direction of application for the types of pressures (indicated by arrows) used to rejoin panel paintings: (1) joining pressure, (2) out-of-plane alignment pressure, and (3) in-plane alignment pressure.

Joining Pressure

BREAKS IN PANEL PAINTINGS frequently require conservation treatment. Generally, panel paintings are rejoined to improve the integrity of the image while preserving the object as a whole. Common problems include joint failure, splits, and a perceived necessity to improve joint alignment. Also, the support may need to be strengthened to forestall deterioration or to prevent the need for reinforcement by other means that may prove more damaging in the long term. In some cases, the option of not rejoining may be preferable.

Though a specialized approach may be recommended for the rejoining¹ of panels, it is not always possible. The following discussion and outline of general considerations might prove helpful in cases where a conservator who seldom encounters the necessity of rejoining finds there are no other means available. Three cases exemplifying panel rejoining methods used at the Hamilton Kerr Institute (HKI) are described. Each case represents a particular rejoining problem and the specific treatment methods and apparatus employed.

Detailed descriptions of rejoining procedures are not common in conservation literature, although various types of apparatus have been mentioned (Hermesdorf 1953; Kozłowski 1962; Glatigny 1989; Reeve 1989). Discussion in the section below entitled “Smaller Apparatus” gives a basic rationale while providing foundation information for the following sections. Finally, some disadvantages of the last apparatus, for treating panels vertically, are discussed. Better methods are continually evolving, so those described should not be taken as a fixed approach.

The pressures applied to rejoin a panel may be divided into two basic types according to their purpose and orientation in space (Fig. 1). The first type, *joining pressure*, as referred to in this article, is usually directed from the opposite edges of the panel, and thence, roughly, through the panel’s plane and perpendicular to the line of the intended joint. This is usually done with bar clamps, though other possibilities exist, such as windlass-type straps, air or hydraulic pressure, and other mechanical devices. The use of bar clamps to rejoin a significantly warped panel can make pressure application difficult. Therefore, it is generally not an ideal method. The panel may bend into a greater warp, risking breakage, damaging the contact area of the joining surfaces, and negating careful alignment.

The second type of pressure, *alignment pressure*, may be subdivided into two categories. *Out-of-plane* alignment describes pressure applied roughly perpendicular to the general plane of the panel to bring the two sides of the joint to the same level.² *In-plane* alignment describes pressure applied parallel to the joint axis, primarily to bring the elements of the image into register on either side of a complete disjoin. In-plane alignment can usually be achieved by maintaining the position of the two panel members carefully by hand during the rejoining procedure. More control may be necessary with smooth-faced disjoins, where slippage is more likely under pressure.

The amount of joining pressure required is determined by the panel's condition. In most cases, much less pressure is used than would be needed for a construction joint. Panel paintings do not require high pressures: pressure should be just enough to bring the joint faces snugly together. If correctly chosen and applied, the glue fills slight gap variations. Too much pressure is dangerous: it can distort the panel and joint, increasing the possibility of damage to the paint and the structure of the wood.

In fact, some conservators prefer not to apply any pressure during rejoining to avoid initiating stress. Of course, depending on environmental conditions following treatment, joints made without the application of pressure still undergo some internal stress. The use of pressure may also be defended for the following reasons: (a) pressure can be beneficial to a good glue bond, and (b) a poorly aligned joint is usually difficult to putty and retouch satisfactorily, especially when a panel painting has a pristine, glossy surface. Therefore, the application of modest pressure to achieve a better joint and alignment may be worth considering.

Approaches to Rejoining

Various systems of wedges and screws with pressures borne by rigid beams have been developed to control alignment pressures. Weights can consist of loosely bagged sand or metal pellets, for example. With practice, such methods can be used with considerable success, though there are usually drawbacks. For one thing, the bulkiness of some apparatus interferes with access and control. Moreover, the careful setting of wedges can be frustrating and tedious and cannot be quickly and easily reproduced if the panel members need to be moved prior to gluing. Sophisticated, ready-made joining tables that address many such problems, however, can be purchased.

Another approach to rejoining uses (usually) V-shaped wooden inserts that are glued into channels cut along the line of splits or disjoins.³ This method will not be discussed here in detail (see Bergeon 1990; Uzielli and Casazza 1994; see also Uzielli, "Historical Overview," and Rothe and Marussich, "Florentine Structural Stabilization Techniques," herein).

Precautions and Suggestions

The rejoining procedure is often technically demanding. For example, although there is a choice of adhesives that vary in ease of reversibility, the difficulties inherent in reversing a dried joint usually involve considerable risk to the structure of the painting, making it desirable to "get it right the first time." For this reason, control and access are important.

Even the simplest rejoining cases may prove stressful to practitioners—this author being no exception. The critical nature of the procedure demands a purposeful, well-planned approach, the necessity of which can

become immediately apparent after the glue has been applied and the joint brought together—a moment when the unforeseen tends to occur. Contingency measures should be planned beforehand. It is important to rehearse the procedure “dry” (without glue) up to the stage of pressure application.

It is also important to consider how well a painting’s condition can accommodate the rejoining procedure. Relevant factors are the condition of the ground and paint layers, whether the layers tend toward flaking, the solubility and reactivity of the adhesive and its components, and the wood’s strength and degree of warp. Weak, porous, water-based animal-glue grounds, for example, might distort or flake during manipulation.⁴

A panel can sometimes be pressured into alignment, but inherent weaknesses could initiate further splits immediately or in the future. The type of panel wood is an important factor. The more flexible woods, such as poplar, may accommodate greater distortions from pressure without failing.⁵ Accepting less than perfect alignment may be the best alternative if further treatment might overstress the panel and painting.⁶

Gluing procedure varies from case to case. Generally, old glue is thoroughly cleaned from complete disjoins, which are then aligned and separated slightly. After glue is applied to both joint faces, the joint is pressed together with relatively low pressure. For more highly concentrated glues, the glue line may be thinned by “rubbing” (slightly moving one joint face back and forth against the other by hand or by small repeated turns of the clamps used to apply out-of-plane alignment pressure). One cannot usually produce a true “rubbed joint” because the joint edges would probably cease to move at a moment when the panel is in the wrong position. However, short of this, a thinner glue line—desirable for durability and a better match to the original joint—can be achieved. As splits must be positioned with greater care, rubbing is normally not possible. For splits, the closest joint is achieved by fitting the torn wood together exactly.

It is not necessary to replane joint faces to eliminate gaps, though some panels have been so treated. Inserts or gap fillers can be used instead. A replaned joint may be suspected if the image no longer registers where it crosses the joint. To identify and then treat this condition effectively, it is best—prior to structural work—to remove the varnish, retouchings, and putties that obscure the joint.

Where joint gaps do occur, fillers may be employed; these may be wooden inserts or part of the adhesive system. If there is an excessive gap and wooden inserts can be fitted effectively without the removal of original wood, they are the preferred choice because they use a thin glue line, which increases durability. Thinner glue lines are more flexible and therefore able to move with the surrounding wood. In contrast, a glue-saturated filling compound is more likely to force the surrounding panel to comply under stresses.

Rejoining and gap filling of joints must be considered in conjunction with preservation of the original panel wood. Some conservators prefer to replace the original wood with wooden inserts, usually V-shaped in section, whose good fit should result in a more complete and thinner bond line than that achieved by rejoining the original wood unaltered. The joints (for two new joints are created) can be made as sound as technical skill, patience, and materials will allow. Again, because the glue line can

be made thin and, therefore, more flexible, joint strength and durability should be better.

However, if sufficient strength can still be achieved, it may be preferable to leave the original wood intact at a disjoin or split to preserve its established relationship with the painted side. Many breaks can be rejoined adequately without removal of the original panel wood. If a panel breaks again in the same area, the original wood can still be repaired or even, as a last resort, replaced. Compromise may be required when insect damage is a factor. In any case, it is probably better to avoid or minimize the loss of original wood support.

Longer joints are difficult to rejoin in one procedure. Glues have limited "open times," during which they are sufficiently liquid to allow effective manipulation. With a larger joint, a step-by-step closure may be advised. The use of insert methods would allow this possibility. The choice of a method, or a combination of methods, is a question of judgment.

Access and Preparation

Access to both sides of a panel, especially the painted side, is desirable in order to assess the effects of the procedure, promote easy glue application and removal, judge the relative position and angle of the two parts being joined, control the degree and direction of pressure for alignment and rejoining, and allow the placement of pressure where it will be most effective.

There are disadvantages in having access to the back only—a limitation that can occur, for example, when the panel is treated facedown on a table surface. The primary drawback is that it is impossible to judge the alignment of the paint surface because it is not visible. This is especially important if the painting has been previously misaligned and the panel subsequently thinned, because the plane of the back surface cannot be relied upon to ensure realignment of the plane of the painted side. The original paint surface usually provides the best basis for alignment.

Access to the true, original paint surface is desirable so that the painting's integrity can be respected during the procedure. Old putties may have been imperceptibly "ramped" to disguise previously misaligned joints so that neither local alignment nor the general plane of the painting surface can be judged with accuracy.⁷ Judgment of the general plane is a particularly subtle exercise that demands thorough familiarity with the panel's surface conformation.

In addition, overlying nonoriginal layers (i.e., putty fragments falling into the joint) can obstruct closure. This usually occurs when all other preparations have been made and the glue has been applied. If a partial disjoin is bridged by such layers and disjoins further during treatment, then original paint on either side of the joint may stick to the overlying layers and be dislodged.

Apparatus for Rejoining Panels

This article describes three types of apparatus used by the author at HKI to glue disjoined or split panel paintings. One is relatively simple in construction and suited to smaller panels. The other two were built for larger panels.

One advantage of the first type is its ease of quick assembly and disassembly. The other two types are more elaborate structures, but they

Figure 2

Screw clamps. One is attached to a double-thickness length of right-angled-section metal.



can be taken apart and rebuilt to suit most larger panels or be customized for a particular situation. All three designs require a degree of thought and planning in their application. However, they are relatively inexpensive, given the control and flexibility they allow in the gluing process.

All of the designs utilize a type of screw clamp, sometimes known as a hold-down clamp, to provide pressure (Fig. 2).⁸ The screw clamp is mounted on a sufficiently rigid beam, usually of right-angled-section metal that is fixed in relation to the panel.⁹ The spatial arrangement of the clamp and beam determines the general direction of pressure. The clamps are used primarily to achieve the desired alignment of joints in relation to the general plane of the panel, that is, to reduce “steps.” They can also be used instead of bar clamps to provide joining pressure—for example, where greater directional control is desired.

The screw clamp can be attached to any suitably thick piece of stock. The thumbscrew of the attachment device may be snugged securely in position with pliers. The clamps are small enough to be placed closely together, and they can be moved to any desired location along the mounting beam. The screw shown can be adjusted through a length of about 20 cm. The circular swivel foot piece can be modified by padding or by the attachment of shaped pieces with various contact areas and rigidities in order to spread the applied pressure as desired.

Smaller Apparatus

Case description

A seventeenth-century panel painting¹⁰ was treated structurally for splits from a cradle locked by glue that could not accommodate the painting’s response to environmental fluctuations. The panel consists of two planks joined parallel to the grain near the center. The grain is oriented vertically with respect to the image. Two splits had occurred since cradling, shown by the lack of glue or varnish in the splits. The splits were stepped to a small degree.

Order of rejoining

The panel, which was almost as thick as it had been originally, had been cradled unnecessarily. The cradle was removed to permit access for rejoining and to serve as a preventive measure against further splitting. The extent of splitting was small, with the splits closed at both ends.

Figure 3

View of the smaller rejoining apparatus, in which the order of assembly is as follows: (1) build and attach the alignment frame(s) to the table crossbars; (2) place two parallel wooden beams on either side; (3) join the bar clamps with threaded rods and place on the wooden beams, through the alignment frame(s); (4) position the panel and adjust supports, clamp positions, and pressures. (To simplify the diagram, only one panel member is shown in position, and the bar-clamp stops are not padded.)

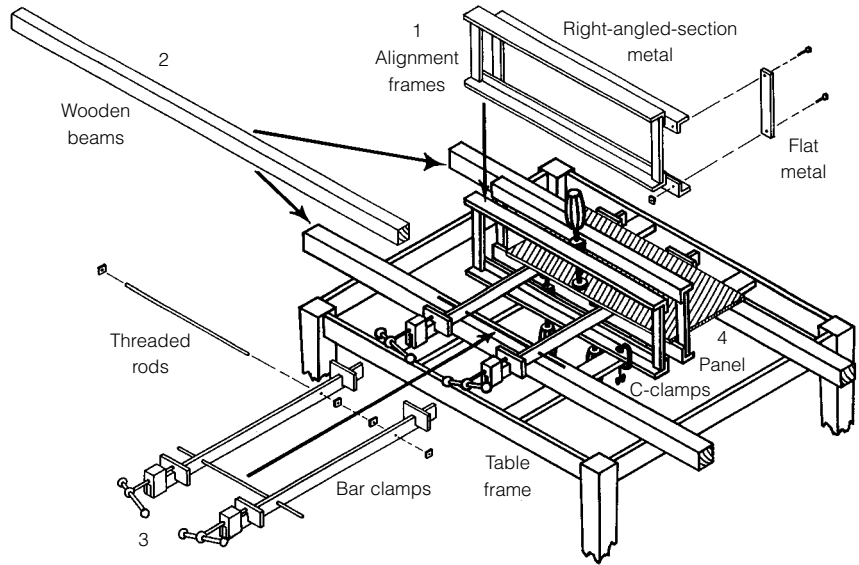

In panels with multiple splits, some running the entire length of the panel, it is preferable to rejoin each section first. This is partly because it becomes more difficult to control the procedure as the size of each section increases. Joining pressures must be directed over increasingly greater spans, and sections with unconsolidated weaknesses, especially larger sections, are more difficult to manipulate than those that have been consolidated.

Apparatus description and application

Construction

The apparatus is supported by a table frame with crossbars (Figs. 3, 4a, b). In order of assembly, a single alignment frame is made first from two equal lengths of right-angled-section aluminum, for lightness and sufficient rigidity. The aluminum lengths should be cut at least 50 mm longer than the dimension of the panel that is parallel to the intended joint. The lengths, which determine the maximum size of panel that can be treated, are drilled at each end and bolted together with two shorter lengths of flat metal to make a rectangular frame. Two such frames, one for each side of the joint, may be necessary to achieve sufficient control of joint alignment perpendicular to the panel plane.

Figure 4a, b

Cornelius Janssens (or Johnson), *Portrait of the Third Earl of Moray*, seventeenth century. Oil on oak panel, 807 × 640 × 7 mm thick. Private collection, Scotland. HKI treatment no. 1475. A view (a) of the rejoining procedure shown from above an end-grain edge. Note the restraining bars to the left and right of the alignment frames, attached with C-clamps to spacer blocks and the table frame below. A view (b) from underneath the middle of the panel shows the alignment frames and six screw clamps fixed to the table crossbar with C-clamps.

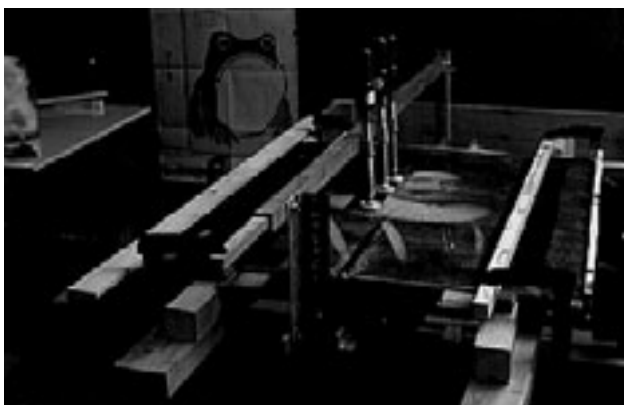

a



b

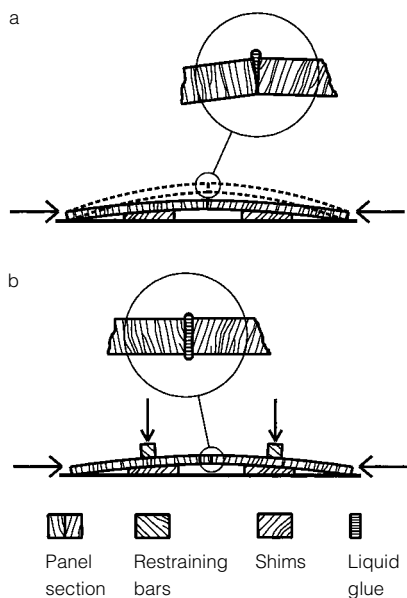

Figure 5a, b

Views of the end-grain edge of a warped panel, with the curvature supported by shims from below. Under joining pressure (indicated by arrows), when the panel is unrestrained (from above) from buckling (a), the joint aligns poorly and a gap is created between the joint faces, which will not be well bridged when the glue shrinks and dries. Padded restraining bars above the panel surface (b) redirect the joining pressure through the joint. The joint faces then meet more squarely and squeeze glue evenly from above and below, indicating a better joint configuration.

The screw clamps will be attached to the angle-sectioned beams above and below the panel joint so that they are on either side and in line with it. First, however, the alignment apparatus is positioned approximately and the bottom beam clamped to the table crossbars with small C-clamps, which stabilize the apparatus.

Next, two straight wooden beams, of about 50×50 mm in cross section, are placed on each side of the alignment frame(s). These may be clamped to the table crossbars. Then, depending on the panel size, at least two bar clamps are laid across the wooden beams and through the rectangular frames. The beams above the lower set of screw clamps support the bar clamps and the panel. The top surface of the bar-clamp rail should lie in the middle of the alignment frame(s). This arrangement defines the panel position in relation to the clamps.

For stability, all the bar clamps may be joined by some relatively rigid means so that they are parallel to one another. In the diagram, two standard threaded steel rods serve the purpose, passing through stop holes and fixed with nuts to either side of each bar clamp. Fixing the clamps together rigidly prevents accidental slips and provides a secure base for the panel. Depending on the panel shape and the angle of the joint relative to the panel edges, the clamps can be positioned at angles to the panel edges rather than placed strictly perpendicularly.

Prior to placement of the panel in the apparatus, the effective contact area of the stops of the bar clamps is extended and padded. A length of relatively rigid bar (e.g., a strip of wood) is placed against the line of bar-clamp stops at each panel edge. A thin balsa plank or strip of card is placed between the rigid bar and the panel edge.

These two pieces distribute the pressure more evenly along the entire panel edge. The batten spreads the point pressures of the stops, and the padding conforms to local irregularities. The padding material can be carved or sectioned to apply pressure to the strongest surface while it avoids weaker areas. The lengths of batten and padding are cut slightly shorter than the respective panel edge. To permit judgment of curvature during the procedure, they are positioned to allow sighting along the end-grain edge of the panel.

Panel manipulation before rejoining

Before glue is applied, a dry rehearsal of the alignment procedure is conducted. To bring both sides together squarely, it is critical to respect the panel's curvature during rejoining. Otherwise, a poor joint usually results, with interruptions of the inherent contours of the panel surface at the joint. If the panel is weak or warped, it should be supported in a state of curvature that minimizes the bending stresses imposed by its own weight. This can be done by placing wooden shims at intervals beneath the panel which are cut to fill the gap between the panel back and the bar clamps (Fig. 5).

The panel is then slid horizontally, painted side up, onto the bar clamps and through the rectangular void of the alignment apparatus until the intended joint is approximately aligned with the line of screw clamps.

Convex warps (viewed from the painted side) often promote buckling when joining pressure is applied. Inherent warp and excessive side pressure increase the tendency to buckle. This pressure can be redirected through the panel toward the desired direction and across the intended joint by the positioning of restraining bars above the panel.

In general, the restraining bars are placed parallel to and approximately halfway between the joint and each parallel panel edge. The bars may be made of padded wooden strips of sufficient rigidity. They should barely contact the panel surface or lie slightly above it. Spacer blocks are placed beneath each end of the bars, and the ends are clamped.

If necessary, the alignment frame is repositioned, after which the screw clamps are lightly snugged to the panel surface. The foot pieces are isolated from the panel and glue with a release film¹¹ and padded, if necessary, with small pieces of mount card or blotting paper. Glue should not contact the card or paper, as it could seep beneath and damage the painting.

Out-of-plane alignment of the joint edges is usually best attained with the least number of screw clamps and with the least pressure applied at the least number of pressure points. The conservator determines the arrangement by trial, repositioning the clamps until the desired effect is achieved. The procedure is usually to move each joint edge alternately, and about equally, until alignment is achieved. One edge should not assume all the strain. Many splits and disjoints realign with ease when the simplest appropriate arrangement of pressure points is used.

Out-of-plane alignment and the best overall curvature may be determined by several methods. These include (1) passing of the fingertips across the joint, (2) repeated passing of the palm across the general area of the joint, (3) use of raking light cast across the joint from both sides, (4) sighting of panel edges at the ends of joints (if appropriate), (5) checking the gap with backlight, and (6) use of raking light or backlight, with straight edges placed over the joint.

During use of these techniques, the joining pressure is tested, a process that previews how the panel shape will change under the anticipated pressure. Alignment pressure may have to be adjusted slightly in accordance with a shape change, and further precautions may be necessary. For example, thinner panels may bend in plane when joining pressure is applied to a joint that is gapped in the middle (Fig. 6). The joint edges contact near each end while the gap is reduced. This type of bending increases as joining pressure is concentrated across the gap. It may occur if the padded bars are not sufficiently rigid—a deficiency that causes pressure concentrations where the bar-clamp stops make contact.

To control these effects, it may be necessary to shim the curved edges of the panel (Fig. 7). Very small movement can have a significant effect on final alignment and bond strength. Shims can be used to concentrate joining pressure to close or reduce slight joint gaps.

Glue application and rejoining

After successful completion of the dry rehearsal discussed above, the conservator can proceed with the application of glue and the actual rejoining. To allow access to the joint for gluing, the top right-angled-section beam(s) and screw clamp(s) may be entirely removed from above the panel, or a bolt may be removed from one end only and the beam(s) hinged up and away. Alternatively, each top screw clamp could be backed off the panel—a maneuver that may be preferable and wastes little time during repositioning after or during glue application. The bottom clamps provide a sufficiently fixed datum if the panel is relocated exactly. Another option would be to mark each screw's position with an ink line across the screw thread and screw housing, back off the clamp, apply the glue, and

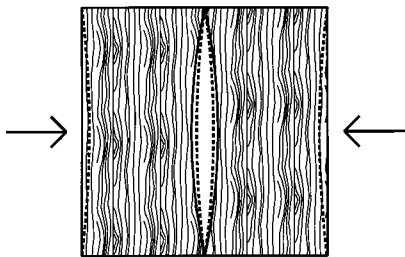

Figure 6
The effect of even joining pressure (indicated by arrows) on a disjoin with a central gap (exaggerated). The dotted lines show movement of the panel under pressure as it bends in-plane.

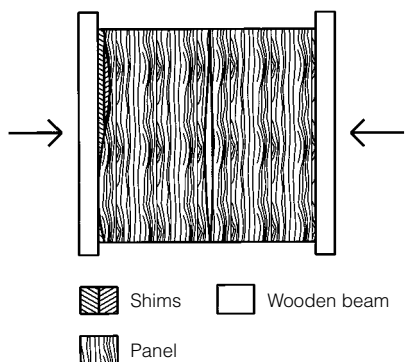

Figure 7
Shims placed in gaps along an uneven edge, left, spread the joining pressure (indicated by arrows) evenly along the joint.

turn the screw back to the mark. For most joining procedures, any disruption of the panel's position relative to the screw clamps necessitates minor readjustment when the joint is finally brought together.

Depending on the joint, the glue can be applied with the entire panel removed from the apparatus, or, if the joint consists of two pieces, one piece can be positioned and clamped in place while the other piece is moved slightly away to create a sufficient gap. The open structure of the apparatus allows considerable access for brushes and fingers.

Next, the glue is applied. Care and ingenuity must be used for partial disjoints, especially splits with both ends closed. An excess of glue is worked into the break, preferably from the panel back. Methods to increase glue penetration include finger pressure, slight flexing of the joint edges, suction, positive air pressure, and use of a syringe or a spatula. For better wetting of the joint faces, a more dilute glue may be applied first, then a more concentrated glue. The highest practical concentration should be used to avoid "starving" the joint,¹² a condition that can occur with glues that shrink or dry by moisture or solvent loss or with glues that are partially absorbed by porous woods.

To produce as complete a joint as possible, it is sometimes better to leave a sufficient line of excess glue on the back of the panel only, since glues that dissolve or disperse in water or solvent usually shrink into the joint. Any outstanding dried glue is then removed to the level of the panel surface.

The clamps are reset, and joining pressure is applied lightly in small increments, with alignment readjusted if the joint slips. The aim is to maintain alignment while forcing excess glue out of the joint in equal measure from the front and back of the panel. This indicates that the joining faces are meeting squarely.

If joining pressure is directed nearer to the front or back of the panel, a gap may result toward the opposite side. This occurs, for example, when a buckling deflection is induced in a panel with an inherent warp (Fig. 5). The chances of making a starved joint can be reduced by a slight increase in overall pressure in two or three stages during the initial drying period. In this way, shrinkage and absorption of the glue are countered by a reduction of the joint gap.

It may be necessary to readjust the alignment screws intermittently between successive increases of joining pressure. This is especially true for thin, flexible panels and for disjoints, where movements are more likely. Disjoints, because they are usually straight and smooth, are often prone to slippage as joining pressure is applied (Fig. 8). Joint slippage can occur imperceptibly, long after the final pressure settings have been made and well into the initial setting stages of the glue. It is necessary to check the alignment repeatedly in all directions until the glue is set to ensure best results.

After the glue has dried, pressure mechanisms are released in the order opposite to which they were applied during the gluing procedure (first the bar clamps, then the alignment screws). The bar clamps are backed off in small increments, in the order and to the degree in which they were applied. Any unexpected movements or sounds may signal a critical weakness. If the alignment screws are released before the bar clamps, then critical support may be removed prematurely from the joint area, and the panel may buckle.

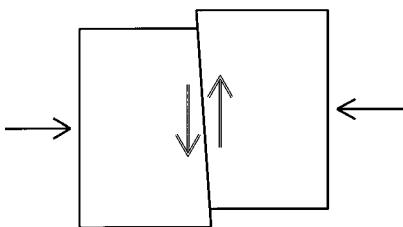

Figure 8
Slippage movement (indicated by vertical arrows) induced under joining pressure (indicated by horizontal arrows). This type of slippage occurs when the axis of the joint is not parallel to the panel edge(s) and therefore is not perpendicular to the applied pressure.

Larger Apparatus for Treating Panels Horizontally

Case description

This apparatus was constructed in 1988. The method follows the principles described in the previous section. Screw clamps are arranged by some means around the panel to provide joining pressure. Alignment pressure is applied perpendicularly to the panel plane.

A more extensively damaged panel¹³ of larger dimensions than the one discussed above necessitated construction of a more versatile combination of support table and rejoining apparatus. It was necessary to remove battens to gain access to splits and to insect-damaged wood. The panel required interim support until all the splits were glued and an auxiliary reinforcement applied. As the restraining battens were removed and the splits glued, it was expected that the panel conformation would vary accordingly, so that the interim support would have to be made adjustable to panel warp. Again, right-angled-section girders were used for construction.

Apparatus description and application

A main table was constructed that could, as work proceeded, support the panel's changing curvature across the grain direction and also provide a framework from which joining apparatus could be applied (Fig. 9a, b). The

Figure 9a, b

Drawing of an apparatus for rejoining larger panels, consisting of a table with extension, shown in elevation (a) from the end-grain edge of the panel. Note the angle adjustment of the extension, which accommodates the panel's curvature, and the turn screws on the left, which are angled so as to direct joining pressure through the panel plane, thereby reducing buckling tendency. A view from below (b) shows the same end of a large panel during the rejoining of a split. The panel is facedown, and the facing is removed only in the area surrounding the split.

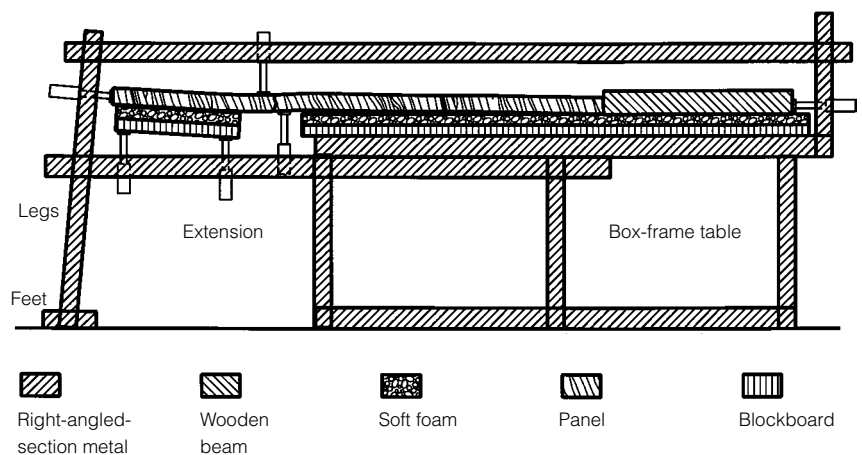

a

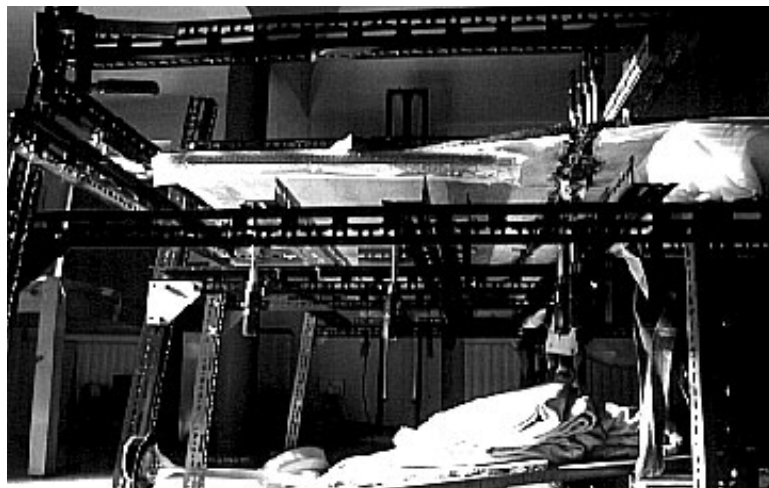

b

table consisted of a box frame of metal girders supporting a top of 25 mm (1-in.) thick blockboard panel fastened with screws from below. A layer of soft, 15 mm thick polyurethane foam sheeting¹⁴ was laid on top, and a release film was secured over the foam.

The main table was extended to accommodate the panel and joining apparatus during gluing procedures. A side edge of the panel was projected over the table edge to expose the split being treated at both the front and the back of the panel. The panel's projected edge was supported by an extension, separated from the main table with a variable gap. The gap allowed access from above and below to the area to be glued. Girders, nested double for sufficient rigidity, were attached to the table frame. Screw clamps could be positioned to apply pressure in any direction for alignment and rejoining.

As work progressed toward the center of the panel, it became necessary to project an increasingly large portion of the painting, supported by the table extension. The extension consisted of a padded panel lying on four upturned screw clamps, which were attached to the girders of the extension frame. The extension girders, in turn, were attached to and extended from beneath the main table. They were of sufficient length to double the main table's width when fully projected.

The padded extension panel was thus made adjustable for angle, height, and distance with respect to the main table. These factors permitted adjustment of the panel's plane to conform with varying warp or to achieve various angles for gluing. Eventually, as more of the painting was projected, it became necessary to reinforce the projected girder ends with footed vertical girder legs that rested on the floor.

As rejoining proceeded, an inherent convex warp¹⁵ became apparent when the panel was viewed from the painted side. The legs could be angled to direct the joining pressure in order to align it with the panel warp. Because the panel was facedown, pressure was directed at a slightly downward angle, in line with the panel's curvature, to prevent buckling.

Batten removal and rejoining began from one side-grain edge and was continued toward the center.¹⁶ After half of the panel was consolidated, it was turned 180° horizontally to treat damages to the other half. For each split the battens were removed from above and to a point just before the next split. The exposed split was then aligned and glued.

Splits occurred at various angles in relation to the panel edge and roughly parallel to the local grain. The direction of any split could be followed closely by the screw-clamp positions, since the girders to which they were attached could be bolted at any angle in the horizontal plane. The top girder(s), with clamps attached and set, could be unbolted at one end and pivoted away from the split for the application of the glue, then repositioned quickly for the application of joining pressure—much as was done with the smaller apparatus.

In such a large rejoining mechanism, the beams that support the alignment apparatus are often not sufficiently rigid, especially when pressure must be applied in the middle of a large panel. Rigidity may be increased by bolting two lengths of girder together in the most useful configuration. Nested T or U sections may be constructed. U sections will allow screw clamps to be placed in parallel lines. Any thickness of timber could also be screwed or bolted to a girder to increase rigidity.

The entire apparatus can be taken apart quickly and easily, and the parts can be stored in a relatively small space or used for another pur-

pose. Several other modifications can be made to the system, depending on need and limited only by imagination.

Larger Apparatus for Treating Panels Vertically

Case description

The treatment of a large eighteenth-century panel¹⁷ suggested another rejoining method. The panel had been thinned. Rigid steel edge strips had been screwed into the end-grain edges of the horizontal planks, preventing movement of the panel across the grain during humidity changes. The resulting constraint caused considerable disjoining, partly because of poor environmental control.

The panel could have been treated horizontally, as in the case described above. However, a more compact apparatus was used to provide access and to make efficient use of studio space. Vertical orientation of the painting is also advantageous because it allows easier access to both sides than if the panel were oriented horizontally. Another benefit is that some aspects of cleaning, filling, and retouching can be conducted in tandem with the structural work if both sides of the panel are almost completely exposed.

Apparatus description and application

A frame/trolley constructed of a metal girder with six wheels for mobility was converted to a temporary support during treatment.¹⁸ A padded ledge was affixed to the trolley bed, and the panel's longest edge was laid onto it, so that the panel planks were vertical with their backs facing outward. Two silicone paper strips placed beneath the lower panel edge reduced friction to allow warp movements. The topmost edge (a side edge of the panel) was supported with a padded length of girder. Thus, the panel was positioned for rejoining, back outward, as if on an easel.

Joining pressure was applied with polyester webbing straps fitted with ratchet-uptake mechanisms. This type of strap, available in various lengths, is typically used to tie down loads for haulage. The principle is similar to that of a windlass-type tourniquet. Such tourniquets can be manipulated to create a greater variety of pressure options than are possible with bar clamps.

Two straps (rather than one) were used. They were joined end to end to encircle the panel—a method that achieved one line of pressure. This method was used because the ratchet mechanism, if it were located on only one side of the panel, would cause unequal tension on each side because of friction at each end of the panel due to strap pressures. The resulting constraint produces a bending pressure toward the uptake side. However, when there is a ratchet on each side, pressure can be applied equally or unequally, as desired.

The joining pressure of the straps was applied to the panel edges through rigid end blocks, made from lengths of padded wood bolted into girder lengths. At each end of the panel, a strap was run through a slot in the girder and around the girder and the outside of the block. Each ratchet was loosely suspended from such an end block, then positioned to bear against the block when pressure was applied. Slings of cord or webbing were used to suspend the end blocks and ratchets from the top retaining bar of the support frame, where the bar projected beyond the borders of the painting. Thus the line of pressure could be directed at any desired

height. The slings also prevented accidental damage that could have resulted if the end blocks had contacted the panel painting.

For longer splits or disjoints, it was necessary to use two or more strap pairs to concentrate the pressure across the entire panel. The number and the location of straps and the lengths of the end blocks determined the location and distribution of pressures.

Alignment was achieved with screw clamps and girder lengths, as discussed for the previous case. In this case the girders were placed on either side of the panel with their longest axes vertical and parallel to the joints or splits. The clamps could be repositioned to adjust alignment. Then, the girders could be unbolted at the bottom and pivoted away on either side of the panel to provide access for glue application. The bars could then be rebolted in virtually the same position, with only slight adjustments to the alignment clamps being necessary.

Each disjoin was treated consecutively across the panel. As work progressed, the girders and clamps were moved to the adjacent disjoin.

There were major disadvantages to the vertical apparatus. For one thing, access to the lower edge was limited—a problem that could be overcome by an improvement in design. Moreover, if a painting is especially heavy and if movement (from changes in moisture content, for example) occurs during treatment, the resulting friction would impose constraint. Another drawback of the vertical apparatus is that gravity can adversely affect the flow of adhesives and consolidants. The vertical orientation can make it difficult to control tools in such procedures as using chisels to fit wooden inserts into areas of severe insect damage, especially toward the lower edge. One final caution is that the vertical orientation can be used only in cases where the paint is secure or well faced, or there may be losses due to flaking.

Acknowledgments

Most described treatments were done while the author was an intern specializing in panel painting conservation at the the Hamilton Kerr Institute (HKI). Thanks go to the Getty Grant Program and to the Samuel H. Kress Foundation, New York, for funding the internship. Other treatments were completed while the author continued at the HKI, employed as a conservator and research associate, thanks to funding by the Leverhulme Trust, London, and the Samuel H. Kress Foundation and the HKI. The author thanks Ian McClure for his support and, above all, for allowing him freedom in pursuing these treatments.

Notes

- 1 In this text the term *rejoining* refers to the gluing of either splits in the wood support or joints that have failed, or *disjoined*, due to a glue line being too weak or deteriorated. The term *joint* is used more generally and refers to the line where two wood members meet or would meet, whether the joint is intact, disjoined, or split.
- 2 The joint edges are displaced such that one edge is above and the other is below the general plane of the panel. Such misalignment is sometimes called a *step* or *stepping*.
- 3 The method described in this article utilizes specialized apparatus to rejoin a particular break in a single gluing procedure. In contrast, the insert method usually rejoins segments of a disjoin in sequential steps so that the joint is treated with successive gluing procedures. The insert method generally avoids the use of joining pressure as defined in this article.

- 4 Generally speaking, most water-based glues used for rejoining are removed easily from a paint surface while they are still moist. It is important to remove them as soon as possible after they contact the paint, since paint losses can result from swelling or solvent effects. Also, strong hygroscopic glues that expand and contract, such as animal (collagen) glues, though soluble when dry, can easily detach underlying paint (see Mecklenburg 1982:figs. 9, 11). Because even a thin remnant of such a glue can detach paint, it should be thoroughly and immediately removed from the paint around the joint.
- 5 This characteristic has probably been the salvation of many poplar panels subjected to stressful framing and reinforcement structures.
- 6 Like many conservation considerations, the determination of what constitutes overstress in the manipulation of a panel painting is generally a matter of judgment, based on experience and common sense.
- 7 Rather than leaving one side of a joint higher than the other, an earlier conservation might have graded a putty or filler between the two levels. Such a grade, or ramp, is often a sign of inaccurate rejoining or of a break that has been superficially treated without structural work.
- 8 The screw clamp's potential was suggested to the author by Professor I. S. Hodgkinson of Queen's University, Kingston, Canada, where it was applied for this purpose. The first apparatus used at HKI was designed and built in winter 1987. See Materials and Suppliers below, for the supplier of the hold-down clamps used in this apparatus.
- 9 This is also known as *slotted angle* and is found in various forms in laboratories in many countries.
- 10 Cornelius Janssens (or Johnson). *Portrait of the Third Earl of Moray*, seventeenth century. Oil on oak panel, 807 × 640 × 7 mm thick. Private collection, Scotland. HKI treatment no. 1475.
- 11 Polyester (polyethylene terephthalate) film.
- 12 A condition in which insufficient glue remains in the joint after drying.
- 13 Marco Palmezzano, *The Mystic Marriage of Saint Catherine*, 1537. Oil and egg tempera on poplar (visual identification) panel, 2560 × 1805 × 20 mm thick. Signed and dated. Property of the Marquess of Northampton. HKI treatment no. 1302. (See Brewer, "Practical Aspects," herein, and Brewer 1994.)
- 14 The foam was used as a thin padding to distribute the weight of the panel. Use of a hard surface, which would have concentrated the weight on too few points over the warped panel surface, would have risked damage to the paint during the relatively long treatment period.
- 15 A curvature typical of substantially thinned panels.
- 16 See the author's discussion of the removal of reinforcements from large panels (Brewer, "Practical Aspects," herein).
- 17 Anton Raphael Mengs, *Noli Me Tangere*, 1771. Oil on walnut panel, 2915 × 1785 × 20 mm thick. The Warden and Fellows of All Souls College, Oxford. HKI treatment no. 73.
- 18 See Brewer, "Practical Aspects," Figures 7, 9a, 9c, herein.

Materials and Suppliers

Hold-down clamps, Trend Machinery and Cutting Tool Ltd., Unit 'N', Penfold Works, Imperial Way, Watford WD2 4YY, England.

References

- Bergeon, S.
1990 *Science et patience, ou La restauration des peintures*. Paris: Editions de la Réunion des Musées Nationaux.
- Brewer, A.
1994 A consolidation/filler system for insect-damaged wood. *Hamilton Kerr Institute Bulletin* 2:68–72.

- Glatigny, J.-A.
1989 Evolution des matériaux utilisés à l'IRPA, Bruxelles, à travers un exemple dans le domaine du collage des panneaux. In *Conservation-restauration des biens culturels: Traitement des supports, travaux interdisciplinaires*, 45–47. Paris: Association des Restaurateurs d'Art et d'Archéologie de Formation Universitaire.
- Hermesdorf, P. J. F. M.
1953 Joining loose members of panel paintings. *Studies in Conservation* 1:87–91.
- Kozlowski, R.
1962 An apparatus for gluing split panels. *Studies in Conservation* 7(4):135–40.
- Mecklenburg, M.
1982 Some aspects of the mechanical behaviour of fabric supported paintings. Report, Smithsonian Institution, Washington, D.C.
- Reeve, A. M.
1989 A new multi-purpose clamping table for the treatment of paintings on wood. *Studies in Conservation* 35:160–62.
- Uzielli, L., and O. Casazza
1994 *Conservazione dei dipinti su tavola*. Fiesole: Nardini Editore.

The Framing of Wooden Panels

Ian McClure

THIS ARTICLE CONSIDERS the problems encountered in the framing of panel paintings in cases where some movement in response to fluctuations in ambient levels of relative humidity (RH)—either in short-term cycles or longer-term, seasonal cycles—is anticipated. The panels considered here are those that can be handled without further reinforcement and that can accommodate some movement without buildup of stress, as well as panels that have support systems that move with the panel and require a rigid frame to enclose and protect them. Particularly sensitive panels—those that are at risk from conflicting tensions in the structure or those weakened by agents of degradation—should always receive further structural treatment or climate-controlled enclosures.

In this article the frame itself is regarded as an auxiliary rigid support. The methods used to construct a frame for a painted panel illustrate several principles: different materials may be employed according to availability; the panel must be able to expand, contract, and warp in response to changes in RH; and in some instances, simple, unobtrusive modifications are made to the frame. The systems described here are the result of experience gained during the fitting of panels for display in places where the environment cannot be precisely controlled, such as in private collections, or in situations where small, unsupported panels have been prepared for transport and display in temporary exhibitions.

The rate of response to fluctuations in RH will vary depending on the thickness of the panel, the type of wood, the cut of the planks from which the panel is made, and the degree of sealing of the reverse of the painting and the endgrain. The framing should also take into account the amount of movement the panel is likely to produce within the range of RH levels in a given environment, and the space for that movement should be built into the frame rabbet.

Notably, the number of articles that discuss framing panels is relatively small; this situation may reflect the fact that framing often falls outside the jurisdiction of the conservator of paintings. With the growing popularity of large-scale traveling exhibitions and with their accompanying risks, however, it is essential to review and evaluate the principles behind framing methods—and perhaps arrive at some comprehensive guidelines.

A historical survey of the framing of panels¹ could start with integral frames, where the frame is carved from the same panel on which the painting is executed, such as the portrait of Emperor Charles V, attributed to the Master of the Magdalen Legend and painted at the beginning of the

sixteenth century (Fig. 1), or a large, complex altarpiece where the molding of the frame is securely attached, sized, and gessoed along with the panel. An example is the San Pier Maggiore altarpiece by Jacopo di Cione, most of which was removed from Florence and is now in the National Gallery, London.² While there is evidence (such as the fixing of battens at only one point on each vertical plank of the painting) that altarpieces were constructed to allow small movements,³ it seems likely that the relative stability of environmental conditions⁴ within the church or chapel mitigated the buildup of tension and stress, which could result in cracking and splitting. Elements of the San Pier Maggiore altarpiece, however, were probably glued, dowelled, and nailed together with battens—procedures that produced a very rigid structure to counter the artwork's size and weight.

In northern Europe, panel and frame construction tended to be more sophisticated than in the south, and frames were routinely designed to allow movement of the panel.⁵ For example, the wings of the Oxburgh Altarpiece, produced in an Antwerp workshop around 1530, have the panels fitted, unglued, into grooves in the frame molding. Despite allowances for movement, large altarpieces of this type are known to have suffered from structural failure due to flaws in their original construction. For example, it has been suggested that modifications had to be made to the wings of van Eyck's Ghent Altarpiece, as the wings proved to be too heavy (Verougstraete-Marcq and Van Schoute 1989:78). In the case of the Oxburgh Altarpiece, structural failure was a result of a restoration that was based on a misunderstanding of the principles behind the original construction. The free expansion and contraction of the panel in its frame had produced a gap between the *malrand* (paint edge) and the frame edge. This was filled and retouched—restorations that proceeded to restrict the panel's movement and cause splits in the panel and tenting and flaking in the paint layer (McClure and Woudhuysen 1994:20–23). The rigidity of the

Figure 1
Master of the Magdalen Legend (attrib.),
Emperor Charles V, early sixteenth century. Oil
on oak panel with integral frame, 34.3 × 23.8
cm. Fitzwilliam Museum, University of
Cambridge (2309).



Figure 2

Antwerp school, Oxburgh Altarpiece (right wing, outer side), ca. 1530. Oil on oak panel, 226 × 114 cm. National Trust, Oxburgh Hall, Norfolk, England. In the lower right corner is a bolt that was inserted later.



Figure 3

Florentine school, *Virgin and Child*, early fifteenth century. Tempera and oil on poplar panel, 84.5 × 45.2 cm. Fitzwilliam Museum, University of Cambridge (1987).

frames of the wings was further weakened by the fitting of brass bolts and keeps in the nineteenth century (Fig. 2).

By the mid-eighteenth century, the movement of paintings from their ecclesiastical settings into private collections and museums had begun. Complex altarpieces were broken up and installed in new, fashionable frames, losing in the process not only cultural context but also, in many cases, structural soundness. For example, the context was obscured in a small *Virgin and Child*, painted in Florence in the 1420s and now in the Fitzwilliam Museum, Cambridge, when the arched top was squared off with a wooden addition decorated with gilded *pastiglia* work, so as to fit a rectangular frame, presumably for display in a secular setting (Fig. 3). A portrait of a man by Memling, originally part of a diptych, depicting a donor and presumably the Virgin and child (part of the Bearsted Collection, Upton House, National Trust), now has a nineteenth-century ornate Gothic frame fitted inside a shadow box. Traces of the original mal-rand survive, as do traces of gilding from the original, integral frame.

There seems to be no evidence that panel paintings were ever fitted with a regard for expansion, contraction, and warping of the panel support before the twentieth century, with the exception of double-sided elements of altarpieces in northern Europe. Even such a grand altarpiece as Carlo Crivelli's *Madonna of the Sparrow*, probably commissioned in the 1490s (National Gallery, London), has developed cracks as a result of its original construction. The altarpiece is largely intact, although the central panel has been thinned and cradled. The predella panel, a single horizontal plank painted with three separate scenes, was securely nailed in with nails

of differing lengths. One nail subsequently caused a horizontal crack (Smith et al. 1989:32, 37, fig. 7).

The method of nailing panels rigidly into frames seems to have become generally employed as soon as frames were recognized as separate from the paint support. It is not uncommon to find panel paintings in British private collections that have been secured in this way and left undisturbed for generations. A pair of early-seventeenth-century portraits of Edward Altham and Elizabeth Altham, from Kingston Lacy House in Dorset, England, now owned by the National Trust, survive in their original frames and have received little, if any, structural conservation measures. Pinned tightly at regular intervals around the edges, the panels, each formed of three vertical oak planks, have been unable to move in response to changing levels of RH. A joint in each panel has failed. In the portrait of the man, the detached section of the panel was simply pinned at a later date with nails of later construction (Figs. 4, 5). At some time before the 1730s, in common with a large number of paintings in the collection, the panels were painted on the reverse with a red, probably ochreous, paint.⁶ This paint layer runs into the split and over the back of the frame, suggesting that the joint had already failed by 1730, as a result of wide fluctuations of RH possibly caused by relocation of the painting; perhaps it was removed to a less well buffered area of the house, such as the attic or servants' quarters, when the style of the portraits became unfashionable or the significance of the sitters was forgotten. The depth of the rabbet of the frame is only about 2 mm greater than the average 6 mm thickness of the panels, indicating that no space for movement was allowed for by the frame maker.

A seventeenth-century view of a church interior after Neefs, from Grimesthorpe Castle in Lincolnshire, has horizontally aligned planks (Fig. 6). The panel has a history of structural failure, as the uppermost joint has opened and has been reglued while misaligned. This initial failure

Figure 4, below

British school, *Portrait of Edward Altham*, 1617. Oil on oak panel, 78.8 × 63.5 cm. National Trust, Kingston Lacy House, Dorset, England. The condition before treatment is shown; the frame is original.

Figure 5, below right

British school, *Portrait of Edward Altham*. Reverse before removal from the frame.



Figure 6

Dutch school, *Church Interior*, mid-seventeenth century. Oil on oak panel, 89.2 × 120.8 cm. Grimesthorpe Castle, Lincolnshire, England.



was followed by the present failure of the lower join; on both occasions these failures were caused by the rigid fixing of the panel into the frame. Regular nicks on the sides of the reverse of the panel, cut for fixings, can be seen (Fig. 7).

An unthinned panel of approximately 1540, *Portrait of a Man with a Watch* (Science Museum, London), attributed to the Florentine painter Maso di san Friano, has regular V-shaped nicks along the top and bottom of the reverse of the panel where nails have secured it to the frame. There is no evidence of similar fixings along the sides. The panel has developed a convex warp, greatest in the center of the panel, between the dovetailed battens, set into channels (Fig. 8).

Figure 7

Dutch school, *Church Interior*. Reverse before removal from the frame.

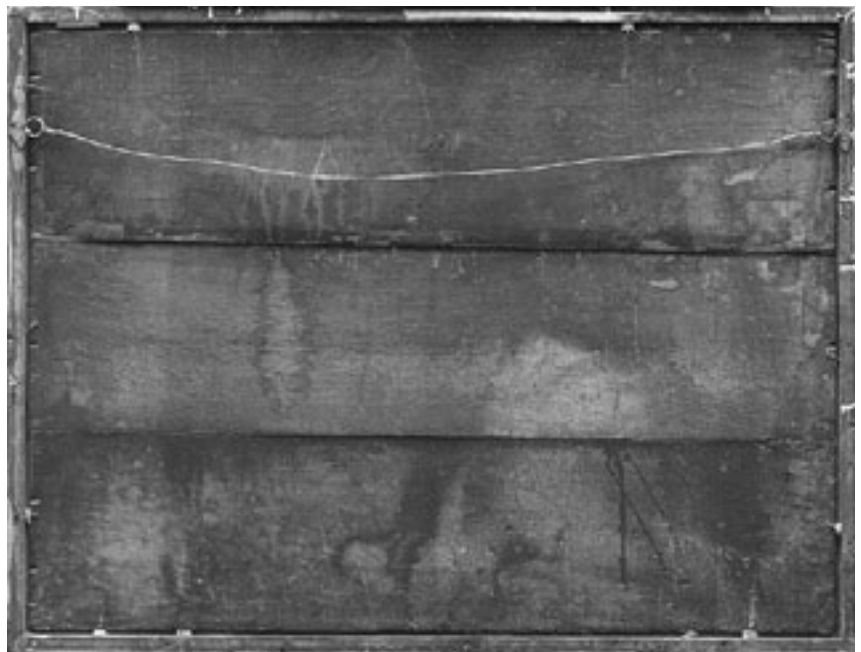



Figure 8
Maso di san Friano (attrib.), *Portrait of a Man with a Watch*, mid-sixteenth century. Reverse. Oil on poplar panel, 117 × 92 cm. Science Museum, London.

The correction of the tendency of panels to develop convex warps when exposed to low ambient levels of RH is probably one reason for the increasing popularity of cradling from the mid-eighteenth century into the first half of the twentieth century. A panel would be thinned by the introduction of moisture and become very responsive to flattening. A cradle would then be attached, to restrain the panel in plane. In this way, the visual disturbance caused by a gap between the frame rabbet and the picture surface could be corrected. By the mid-nineteenth century, panels were routinely thinned and cradled, and even as late as the 1960s the desirability of a flat picture plane was cited as a reason for major intervention.⁷ Today it is generally accepted that panel paintings should be allowed to assume a natural warp at a given RH and that the frame should be adjusted to suit such movement.

The principles behind early-twentieth-century solutions to the problems of framing panels hardly differ from those we recognize today. In 1936 in the National Gallery of Scotland, the wings of the Trinity Chapel Altarpiece relied on the provision of a microclimate enclosure, the exterior of which served as the frame (Cursiter 1936:109–16). In 1940 the International Office of Museums recommended, among other urgent concerns, the use of steel springs in framing panels to allow movement and added the proviso that they should be removed for transport (International Office of Museums 1940:80, 81, n. 58, 59). In 1955 George Stout, as part of the survey of panel treatments instigated by the International Council of Museums Commission for the Care of Paintings, illustrated examples of frames causing splits in panels and of panels causing the breaking of frames. Several systems for fitting panels were illustrated, including a system for supporting a panel with unglued cracks.⁸ In 1965 Straub recommended the use of flexible strips of sprung steel to allow warping. This apparatus could be combined with a backing to provide protection against shock and to act a buffer against changing climatic conditions (Straub 1965). Similarly, in 1978 Goetghebeur recognized the use of the picture frame to support panels and suggested the use of sprung steel strips to allow movement (Goetghebeur 1978). In 1982 Ranacher largely repeated Straub's recommendations (Ranacher 1982:147); the same year Vöhringer described a framing system for a sixteenth-century panel which supported the panel in the center and allowed movement at the edges by means of a leaf spring held in place by a U-section metal bracket and adjusted by a threaded bolt (Vöhringer 1982:fig. 9). In 1988 Dunkerton and coworkers described the widening of the groove of a later double-sided frame housing the wings of an altarpiece by Martin van Heemskerck (Dunkerton, Burnstock, and Smith 1988:20). Low-density foam was fitted in grooves on both sides of the panel to allow some movement. Hermesdorf, in 1989, described a system of suspending the panel on aluminium strips attached to the frame. Wooden buttons, normally reinforcing reglued joins and splits, had slots cut in them that fitted over the aluminum sections (Hermesdorf 1989:267–69). The use of roller bearings attached to the base of a support for a large panel with horizontally aligned planks and running on tracks on the bottom rabbet section of the frame significantly reduces static friction between the panel base and frame, allowing the panel to move in response to changes in RH (see Bobak, "A Flexible Unattached Auxiliary Support," and Marchant, "Development of a Flexible Attached Auxiliary Support," herein).

These methods reflect the current belief that panel paintings should be allowed to move, perhaps within limits, to adopt greater or

smaller curves in response to changes in ambient RH. Observation of particular panels under varying levels of RH can reveal a surprising degree of warping over a short period of time. For example, in 1987 the Hamilton Kerr Institute, in Cambridge, England, treated an early-sixteenth-century poplar panel, *The Adoration of the Shepherds*, attributed to the Master of Santa Lucia sul Prato. The panel, measuring 169×162.5 cm, had been thinned to 1 cm and was heavily cradled. After the cradle was removed and the splits were reglued, the panel developed a convex warp of 3 cm across its width at an RH of about 55%. A reduction or increase of 10% produced an increase or reduction of the warp by 1 cm in just two hours. Rigid fixing of the panel in its frame would have inevitably produced rupture of the wood or of the glued joins.⁹ Stout, in describing a formula to calculate the force required to constrain and flatten a warped panel temporarily straightened by moisture, gave a formula to calculate the force required to rupture the panel; that formula could then be used to calculate a safety margin in framing (Stout 1955:158–59). In practice, however, evaluation of the force required for the panel to deflect the frame fixings seems only recently to have been assessed. In 1991 Mecklenburg and Tumosa produced computer models of cracked and uncracked oak panels rigidly fixed into their frames and assessed their resistance to splitting. An uncracked oak panel measuring $76 \times 102 \times 1.27$ cm thick could be split by fluctuations of RH between 70% and 10%. When a cracked panel of similar dimensions is subjected to strain, much less force is required to extend the cracks (Mecklenburg and Tumosa 1991:187ff.). Thinned poplar panels, often weakened to a far greater extent than oak by boring insects, are likely to split under much lighter loads.

The author has not found any assessment of the force exerted either by flexible spring fixings, commonly used to secure panel paintings, or by malleable brass fixings, which might be expected to distort under loading, thereby preventing undue stress to the panel or elastic foam of a known density (Plastazote and Evazote of a density of 50 kg m^{-3} are commonly used).¹⁰ However, a simple experiment demonstrates that the force required to deflect a particular fixing is much greater than might be expected. Two commonly used sprung-steel fixings and four brass fixings of different dimensions were screwed to a length of wood. Holes (or in the case of one spring fixing, a hook) were provided to attach a spring balance. The force required to raise a fixing by 1 cm was observed. The length of each fixing, which affects the moment of the force generated, was not assessed. The spring fixings required a loading of 0.8–1.4 kg to deflect them 10 mm from an unstressed position. A force of 2.8 kg was required to move the three smaller malleable brass strips 10 mm; a force of 1.8 kg was required to move the largest brass fixing, a result that reflected the increasing moment as the length increased. Foam blocks of varying density require an often-underestimated force to compress the foam to accommodate a warp. For example, three foam blocks, 3 cm cubes cut from Evazote of 50 kg m^{-3} in density and set in line at 10 cm centers under a strip of wood, required a weight of 7.3 kg to compress the blocks by 5 mm. Two identical blocks at 10 cm centers under the same wooden strip required a weight of 5.5 kg to compress them by 5 mm. A single foam block under the wooden strip required a weight of 2.7 kg to compress it by 5 mm. The force exerted by the metal fixing devices described above, when the panel moves against them, could in many cases come close to or exceed the rupture strength of the wood, especially when the

wood is weakened by splits or degraded by woodworm damage, and when glued joints are embrittled by age. It is doubtful that any calculation could be devised to give a value for the elasticity of the wooden panel at right angles to the grain—there being so many variables and features peculiar to each panel. It seems that framing systems that exert minimal restraining force at the edges and parallel to the wood grain are least likely to cause damage. A framing system to achieve such a goal would have to be designed on an individual basis, with the construction and inherent stresses of each panel, as well as its display and travel requirements, taken into account. It is an important consideration that systems that hold the panel while allowing maximum movement often provide insufficient support when the panel is moved.

Three case studies illustrate techniques employed at the Hamilton Kerr Institute. The first, the framing of a small panel of three vertical planks, the *Portrait of Elizabeth Altham*, has been mentioned above. The second is the framing of the large altarpiece *Noli Me Tangere* by Anton Raphael Mengs, with horizontally aligned planks; the frame of that work required considerable strengthening. The third is an altarpiece, attributed to Pietro Gerini, which had been reframed in the nineteenth century. Even though the frame was causing splitting in the three panels, the client wished the altarpiece to remain unchanged in appearance after treatment.

Portrait of Elizabeth Altham

The 1617 panel, one of a pair of seventeenth-century portraits, was in its original frame of oak painted black and partly gilded. The joints of the panel had opened. After gluing, the panel was observed to assess the maximum curvature it would develop. It became slightly convex at an RH of 50%. It was decided to increase the depth of the frame rabbet from 8 mm to 18 mm. Strips of dimensionally stable spruce were cut and angled to the outside edges of the frame to make the addition inconspicuous. Strips 25 mm in width were mitered, stained dark, and attached with screws to the back of the frame. (The use of glue was rejected as less reversible.) The addition is not visible when the frame is hanging, and only a slightly larger gap between frame and wall is evident. The panel fitted quite closely to the rabbet, which did not require any addition of shaped sections to follow the panel's curvature. Rabbets can be adjusted to remove the gap between the sides of the panel and the frame edge, which can be visually distracting, especially where light can be seen between the picture frame and the wall. However, a curved rabbet can itself restrict movement if the panel is subjected to higher RH levels; in such a case the sides of the panel across the grain will press against the outer edge of the rabbet and the nearest top and bottom fixing points, exerting pressure on weak areas and joints. The panel must be able to assume a less convex profile; this is facilitated either when space is left for movement at the edges or when the central fixings are designed to compress, allowing the panel to move away from the frame rabbet in the center. Compressible curved additions to the rabbet could be made. However, any material that can be accurately shaped and that presents a visually acceptable surface, such as Plastazote or Evazote, is likely to be too rigid to conform to changes to the configuration of the panel.

The panel was then fitted in the frame. The central vertical plank was set on a thin, 15 mm strip of hardwood. This raised the lower edges of the panel away from the bottom edges of the frame, allowing free move-

ment. Small blocks of Evazote, with the bottom edges shaped to align with the chamfered edge of the panel, were cut. A groove was cut in the top of the blocks to position the brass fixing strip and prevent the foam block from accidentally falling out. The brass fixing strip was bent at a right angle at its end to retain the block. It was then screwed to the base of the frame addition and curved to hook over the back edge of the addition so that it could not be twisted out of position. These fixings were placed toward each edge of a central plank (Fig. 9).

Noli Me Tangere by
Anton Raphael Mengs

The structural conservation of this large painting is described elsewhere (see Brewer, "Some Rejoining Methods," herein). Even after an auxiliary support in the form of battens was applied to the reverse, it was felt that the frame should supply further support. As the weight of the panel itself is estimated to be about 100 kg and the planks are horizontally aligned, it was decided to modify the system designed by Ray Marchant for a painting by Alexander Kierincx and Roelant Savery (see Marchant, "Development of a Flexible Attached Auxiliary Support," herein). This system would reduce the friction between the bottom edge of the panel and the frame by attaching roller bearings to the panel, locating them in slots in the depth of the frame rabbet. The existing frame originally had no rabbet, and so later additions were removed, and a new back rail, 19 cm in depth, was made to accommodate the panel and batten system and a movement of about 2 cm in either direction. This back rail was glued and screwed to the back of the frame for maximum strength and painted to match the sides of the frame. The lower ends of the four battens supporting the picture were then fitted with inserts, so that an L-shaped aluminum section could be bolted on to support the weight of the panel when upright. A pine spacer shaped to counter the angled edge of the panel due to the convex warp was fitted between the base of the panel and the aluminum section to spread the weight of the panel evenly. The L-shaped aluminum

Figure 9
British school, *Portrait of Elizabeth Altham*,
1617. Reverse. Oil on oak panel, 79 x 63.5 cm.
National Trust, Kingston Lacy House, Dorset,
England. Modifications to the original frame
are shown.



section protruded in front of the panel by 5 mm to enable the block holding the roller bearings to be set in the line of the center of gravity of the panel. The blocks of aluminum were bolted to a strip of 6 mm aluminum, which was bolted in turn to the L-shaped aluminum section to increase rigidity. The bearings run in the slots cut in the bottom rabbet of the frame, which are lined with stainless steel strips to prevent the bearings from denting the wood and locking the system. When upright, the panel rests on the bottom edge of the frame and against shaped rabbets on either side. The panel is held in the frame across the center by two horizontal battens resting on the panel battens and attached to the frame by bolts and compression springs to allow some movement in the event the panel should assume a less convex profile (Figs. 10, 11a, b).

Triptych attributed to Pietro Gerini

When received for treatment, the three elements of the triptych—a central single poplar panel of the Madonna and child, flanked by panels of two vertical planks with arcading attached above—were held together by three battens screwed to each panel in turn (Hamilton Kerr Institute 1984) (Figs. 12, 13). At the front, the decorated base was screwed to the lower edges of the panel. This rigid construction, probably made in the late nineteenth century in France, as the provenance suggests, had caused the opening of splits in the left and right panels and two splits in the central panel. The two columns separating the wings from the center were contemporary with the rest of the frame.

The components of the altarpiece were dismantled. The battens were unscrewed and the columns and pilasters gently prized off. A new framework to hold the panels was constructed from pine, stained to be unobtrusive, and then sealed with polyurethane varnish to reduce dimensional change in the structure (Fig. 14). The frame's base was adjusted with balsa-wood spacers to hold the three panels at the correct alignment (Fig. 15). Each outside panel was attached by the base of the support and by a shaped brass strip fixed to the back of the framework at the upper rail. The central panel was similarly attached at the base and attached by steel hooks to existing original fixings in the panel above the pilasters. Two vertical strips of wood were placed over the joins between the central panel and the outer panels and were held in place by stainless steel bolts

Figure 10
Anton Raphael Mengs, *Noli Me Tangere*, 1771.
Reverse. Oil on walnut panel, 291.5 × 178.5
cm. All Souls College, Oxford.

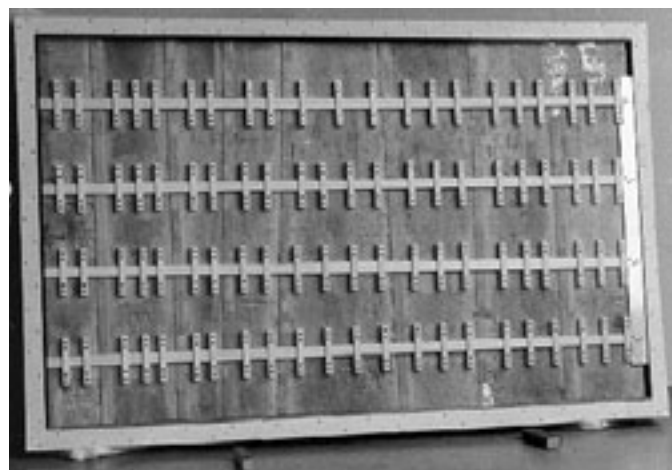
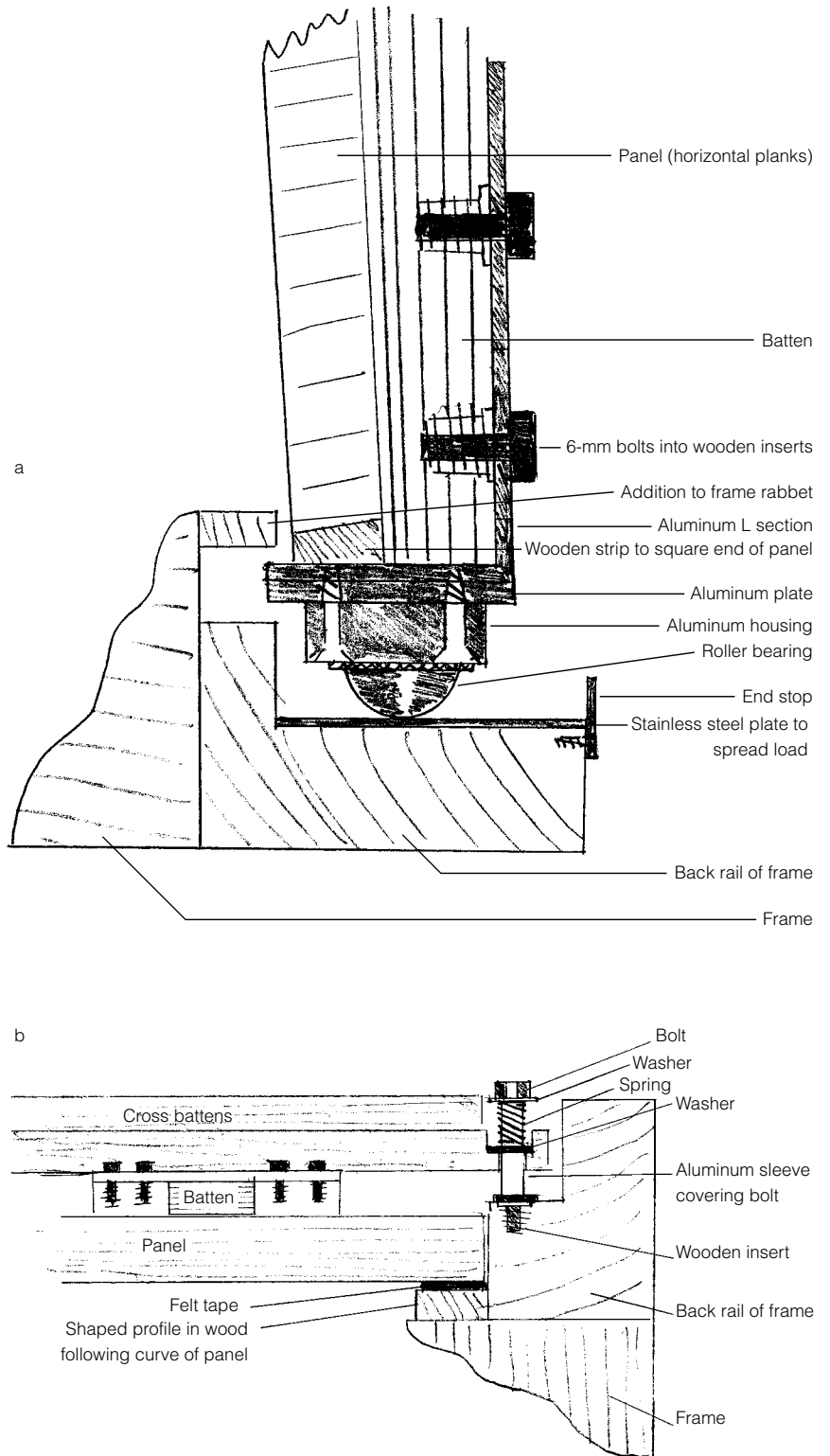

Figure 11a, b
 Anton Raphael Mengs, *Noli Me Tangere*.
 Diagram of (a) roller bearing fixings, and
 (b) sprung framing battens.



that passed through the gap between the three panels and that were bolted to the framework with provision for adjustment. The three panels were thus held and supported without any restriction to their movement.

To comply with the client's wishes, the nineteenth-century columns and base were put back. The decorated base was attached to the base of the framework, the bases of the columns at each end were



Figure 12, above
Pietro Gerini (attrib.), *Triptych*. Acqueous medium on poplar panel, 165 × 180 cm. Private collection. The condition before treatment is shown.

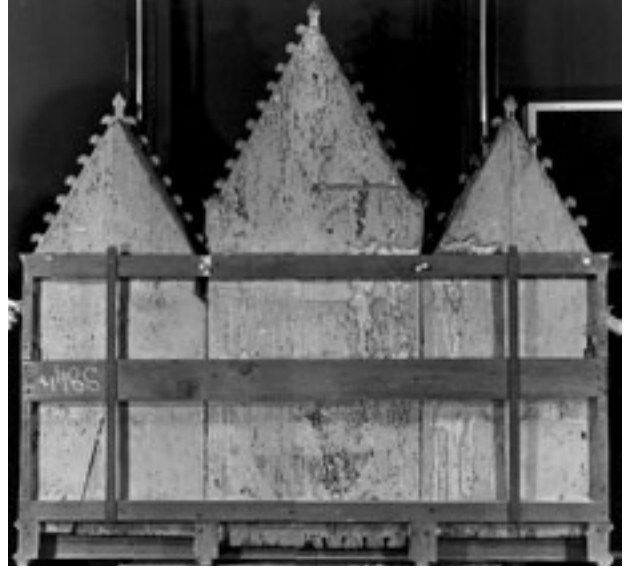

Figure 13, above right
Pietro Gerini (attrib.), *Triptych*. Reverse before treatment.

Figure 14, below
Pietro Gerini (attrib.), *Triptych*. Reverse after treatment.

Figure 15, below right
Pietro Gerini (attrib.), *Triptych*. Diagram of the framework.

lengthened, and the pilasters above the spring of the arches were refixed (those on either side of the central panel to that panel only). The sides of the framework were chamfered to echo the shape of the columns, and new central columns were made to cover the strips supporting the panels on either side of the central panel. The columns, slotted behind the capitals and held in place at the bottom by a thin base plate screwed onto the base of the framework, were prepared and gilded to match the rest of the framing elements. The reframed altarpiece differed only in minute detail from its previous appearance—yet the panels were unrestricted, and the frame could be easily dismantled and reassembled (Fig. 16).

It is hoped that these examples demonstrate a valid and flexible approach to the framing of panels. The solutions devised here are not presented as models to be copied but, rather, as proposed methods that can be adapted and improved.

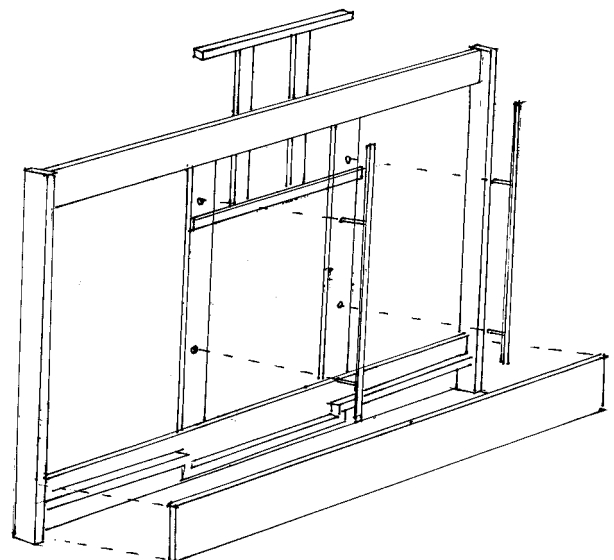

Figure 16

Pietro Gerini (attrib.), *Triptych*. The condition after treatment is shown.



Acknowledgments

The author is grateful to Kathryn Hebb for her help with this article, as well as to Ray Marchant for his help and advice.

Notes

- 1 For a well-illustrated history of frame styles, see Grimm 1978. An important study of Dutch frames in the seventeenth century is van Thiel and Kops 1984.
- 2 National Gallery, London, cats. 569–78. A full account of the technique and construction of the altarpiece can be found in Bomford et al. 1989, especially 156ff.
- 3 For a succinct account of the construction of early Italian altarpieces, see the introduction by Bisacca and Kanter in Newbery, Bisacca, and Kanter 1990:11–30. See also Cämmerer-George (1966) for illustrations of altarpiece construction.
- 4 See Lacey 1970:65–80, for a study of the environment in Kings College Chapel, Cambridge, before the installation of the large panel of *The Adoration of the Magi* by Rubens. The considerable buffering effect of the stone is assessed, as are the effects of low-level winter heating, which contributed to an annual fluctuation of mean levels of RH between 55% and 70%, with very slow rates of change.
- 5 For a detailed account of Flemish altarpiece construction, see Verougstraete-Marcq and Van Schoute 1989:78, where the problems encountered with the original design of the wings of the Ghent Altarpiece are discussed.
- 6 A list of paintings mended and cleaned by George Dowdney in 1731 survives. The linings of several of the Lely portraits were eighteenth century and had been coated with red paint on the reverse, presumably as a moisture barrier. See Laing 1993:107–31, especially n. 18.
- 7 For example, Helmut Ruhemann’s comment on the “semi-transfer” of the *Nativity* by Piero della Francesca, “which did not leave the picture quite flat nor absolutely stable” (Ruhemann 1968:161, n. 2).
- 8 Stout 1955:figs. 22–24. For fitting panels in frames, see figs. 50, 52, and 53.
- 9 See Hamilton Kerr Institute 1987, where the work is attributed to the school of Ghirlandaio. The painting is in a private collection.
- 10 Plastazote is a low-density, cross-linked, closed-cell polyethylene foam. Evazote is a low-density, cross-linked, closed-cell ethylene vinyl acetate foam.

Materials and Suppliers

Brass fixing strips of various sizes, J. Shiner and Sons, 8 Windmill Street, London W1P 1HF, England.

Plastazote and Evazote, BXL Plastics, ERP Division, Mitcham Road, Croydon, Surrey CR9 3AL, England.

Roller bearings, Always Engineering, Warner Street, Birmingham, B12 0JG, England.

Self-adhesive acrylic felt tape (for lining rabbets of frames), George B. Tewes Co., Western Felt and Fiber, 323 South Date Avenue, Alhambra, CA 91803.

References

- 1989 **Bomford, David, Jill Dunkerton, Gordon Dillian, and Roy Ashok**
Art in the Making: Italian Painting before 1400. London: National Gallery.
- 1966 **Cämmerer-George, Monika**
Die Rahmung der Toskanischen Altarbilder im Trecento. Strasbourg: P. H. Heitz.
- 1936 **Cursiter, Stanley**
Notes: Control of air in cases and frames. *Technical Studies in the Field of Fine Arts* 5(October):109–16.
- 1988 **Dunkerton, Jill, Aviva Burnstock, and Alastair Smith**
Two wings of an altarpiece by Martin Van Heemskerck. *National Gallery Technical Bulletin* 12:16–35.
- 1978 **Goetghebeur, Nicole**
Treatment of panels at the Institut Royal de Patrimoine Artistique. In *Conservation of Wood in Painting and the Decorative Arts: Preprints of the Contributions to the Oxford Congress, 17–23 September 1978*, ed. N. S. Brommelle, Anne Moncrieff, and Perry Smith, 165–68. London: International Institute for the Conservation of Historic and Artistic Works.
- 1978 **Grimm, Claus**
Late Bilderrahmen. Munich: D. W. Callwey.
- 1984 **Hamilton Kerr Institute**
Triptych, attrib. Pietro Gerini. Conservation Report 783, Hamilton Kerr Institute, Cambridge, England.
- 1987 *The Adoration of the Shepherds*, School of Ghirlandaio. Conservation Report 992, Hamilton Kerr Institute, Cambridge, England.
- 1989 **Hermesdorf, Peter**
Konservierung und Montage bemalter Holztafeln. *Restaurio* 95(4):267–69.
- 1940 **International Office of Museums**
The Manual on the Conservation of Paintings. Paris: International Office of Museums.
- 1970 **Lacey, Ralph**
A note on the climate of a medieval chapel. *Studies in Conservation* 15:65–80.
- 1993 **Laing, Alastair**
Sir Peter Lely and Sir Ralph Bankes. In *Art and Patronage in the Caroline Court*, ed. David Howarth, 107–31. Cambridge: Cambridge University Press.
- 1994 **McClure, Ian, and Renate Woudhuysen**
The Oxburgh Chapel Altarpiece: Examination and conservation. *Apollo* 139(387):20–23.

- Mecklenburg, Marion, and Charles Tumosa
1991 Mechanical behaviour of paintings subjected to changes in temperature and relative humidity. In *Art in Transit: Studies in the Transport of Paintings*, ed. Marion Mecklenburg, 173–216. Washington, D.C.: National Gallery of Art.
- Newbery, Timothy, George Bisacca, and Laurence Kanter
1990 *Italian Renaissance Frames*. New York: Metropolitan Museum of Art.
- Ranacher, Maria
1982 Gemäldebefestigung im Rahmen. *Restauratorenblätter* 6:147.
- Ruhemann, Helmut
1968 *The Cleaning of Paintings*. London: Faber and Faber.
- Smith, Alastair, Anthony Reeve, Christine Powell, and Aviva Burnstock
1989 An altarpiece and its frame. *National Gallery Technical Bulletin* 13:28–43.
- Stout, George, ed.
1955 The care of wood panels. *Museum* 8:139–94.
- Straub, Rolf
1965 Einrahmung (Section S), part 1 (Holztafeln). In *Konzervierung und Denkmalpflege*. Zurich: Institut für Kunstwissenschaft.
- van Theil, P. J. J., and C. J. de Bruyn Kops, eds.
1984 *Prijst de Lijst*. Amsterdam: Rijksmuseum.
- Verougstraete-Marcq, Hélène, and Roger Van Schoute
1989 *Cadres et supports dans la peinture flamande aux 15e et 16e siècles*. Heure-le-Romain, Belgium: H. Verougstraete-Marcq.
- Vöhringer, Brigitte
1982 Praktische Möglichkeiten der Restaurierung von Holztafelbildern am Beispiel der Gebots-Tafel aus der Kreuzkirche in Dresden. In *Beiträge zur Erhaltung von Kunstwerken*, ed. Ingo Timon, Hans-Joachim Granan, Angela Mölles, and Christine Heidenreich, 95–103. Berlin: Verband Bildener Künstler.

Practical Aspects of the Structural Conservation of Large Panel Paintings

Al Brewer

A SUBSTANTIAL PROPORTION of paintings treated at the Hamilton Kerr Institute (HKI) in Cambridge, England, have been on wooden supports. This article uses examples to show the underlying causes and mechanisms that determine treatment decisions in practice.

General Considerations

Scales of damage and treatment constraints

Large panels have sufficient weight and size in the cross-grain dimension¹ so that a number of considerations arise that are generally less significant in smaller panels. Greater damages are found—breaks of greater number and length and larger areas of biological deterioration—with corresponding treatment implications. Liters of (usually toxic) consolidant may be needed for a large volume of insect-damaged wood, requiring large-scale application methods and large-capacity fume extraction. Thus, treatment methods are scaled accordingly and should be made as efficient as possible, while, of course, being subject to conservation demands.

Structural stabilization concerns for large panels must be balanced with restrictions in time, cost, and methodology. The greater logistics generally make treatment more difficult, demand more time and appropriate methods, and therefore increase total costs. Satisfactory results may require a complex treatment and some ingenuity.

Environmental considerations and wood movement

Environmental conditions are constantly changing, however slightly, so that panels of wood are *constantly* moving in response to changing moisture content (MC).² Depending on the panel structure, such *wood movement* may be relatively small or slow, and therefore not easily perceived. Generally, larger panels change MC more slowly, although movement may still be relatively fast, especially for thinner panels. Even when housed with the best environmental controls, panel paintings are unlikely to reach a stable equilibrium moisture content (EMC) with level moisture gradients and cessation of movement.

Relative humidity (RH) should be as stable as possible during treatment. Total *lateral* movement (across the wood grain and in the plane of the panel)³ and *warp* movement (perpendicular to the panel plane) vary directly with the panel's dimension across the grain.⁴ The location

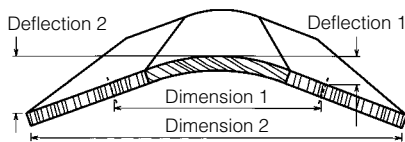

Figure 1, above

A panel, consisting of three planks, viewed from slightly above one end of the planks. A greater cross-grain dimension would “magnify” the deflection of the middle plank in the diagram. This is shown as the difference between deflection 1, for a smaller panel of dimension 1, and deflection 2, for a larger panel of dimension 2.

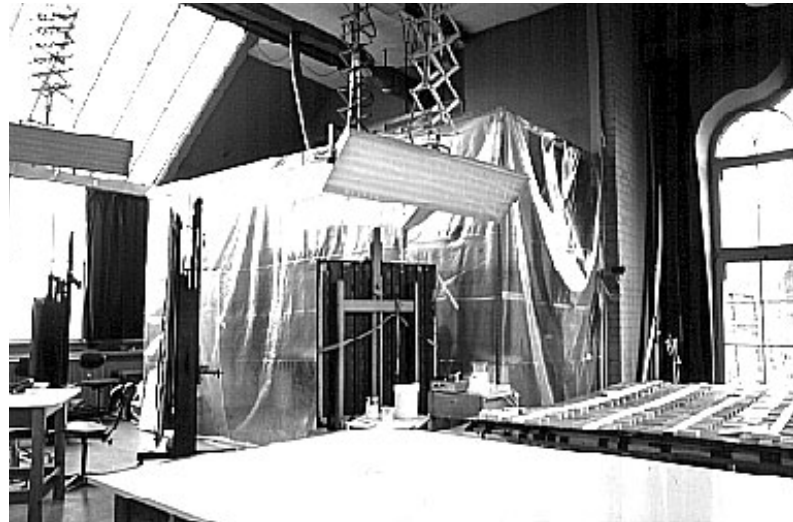

Figure 2, right

A tent enclosure for treatment of a large panel, built to sustain RH and temperature at approximately the same levels as in the panel’s normal environment.

of warp-prone areas is also a factor. For example, planks cut tangentially are more prone to warp movement. If a warp-prone area is located toward the middle of a panel, the movement will be transmitted to the panel’s (longitudinal-grain) edges so that the overall deflection may be somewhat greater than that of the central plank (Fig. 1).⁵ Since this is an angular relationship, deflection of the panel edges may be almost instantaneous, especially for larger, thinner panels that are more flexible and therefore more responsive.⁶

Treatment RH should be similar to that of the panel’s normal or destined location (Fig. 2). If not, after the panel is relocated there will be further movement opposing any restraints imposed by rejoining, reinforcement, or framing. Effective treatment should lessen potential stresses in the painting structure as much as possible.

Proportional increase in total wood movement has other implications for panels of larger cross-grain dimensions. The development of end-grain splits or checks is well-known in the drying of commercial oak timber, especially larger sections. This is partly due to much higher moisture permeability through end-grain, where oak’s large-diameter vessels play a part, than through side-grain surfaces.⁷ A similar phenomenon seems evident with respect to wood movement in oak panel paintings where cyclic compression sets and tensions provoke end-grain fractures (Desch 1956:93–95) and disjoints. These effects are proportionally greater in wider planks. Like oak, walnut has relatively high density and large vessels. Figure 3 shows a joint between wide walnut planks that had parted several times, developing an ever-increasing gap, evident from the stratigraphy of three or four putty layers.⁸

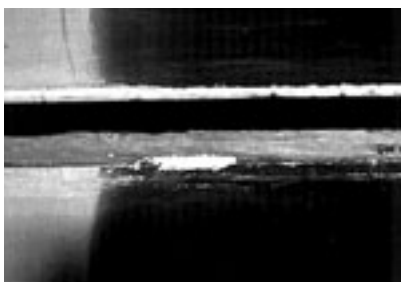

Figure 3

A gap in a joint toward one end of the adjoining planks shown after several strata of overlying nonoriginal layers and putty were removed. Since disjoining, the plank edges had developed a step that had been subsequently abraded to the same level. The length of joint shown is about 300 mm.

Structure of larger panels

Structure determines many aspects of conservation. Tree species that grow larger and yield larger planks have usually been used in large panels. White poplar (*Populus alba* L.), oak (*Quercus* spp.), and Scots pine (*Pinus sylvestris* L.) are examples. Large panels are sometimes made from relatively small planks, as in some of Rubens’s larger landscapes (Brown, Reeve, and Wyld 1982).

Some unusual woods may be found. Raphael's *Transfiguration*,⁹ painted on cherry wood (*Prunus arium* L.), is a very large panel (Mancinelli 1990:150). Italian panels are usually associated with white poplar (Bomford et al. 1989:11), linden (*Tilia* spp.) (Klein and Bauch 1990), and perhaps willow (*Salix* spp.),¹⁰ so a very large panel of cherry is unusual.

Figure 4a–c shows an Italian painting on white poplar consisting of six vertical planks cut to a round top. Though it seemed slightly heavy, the wood density is within poplar's rather broad range (Jobling 1990:66). This panel would originally have been about 40–50 mm thick. Poplar has been justly preferred for large panels because of its high strength-to-weight ratio, ease of tooling and preparation, and moderate movement (Lincoln 1986:221).

In rare examples, one or two large planks may suffice for a support. Figure 5a, b shows a painting by J. M. W. Turner on a single mahogany plank. Its "sister" painting is similarly constructed.¹¹ Both panel paintings remain in extremely good condition, which is not unusual for sound mahogany panels¹² in a near-original state—that is, unaltered by thinning, cutting down, and so forth. Neither is restrained by an auxiliary support. If excessive, such restraint can be detrimental, particularly for larger panels. Movement of mahogany is small (Lincoln 1986:159), an advantage for preservation. With radially sawn planks and sound preparation, such panel paintings tend to be durable.

In "portrait" format, vertical planks are a more structurally sound arrangement than horizontal planks. Generally, rectangular panels have

Figure 4a–c (4c on next page)

Marco Palmezzano, *The Mystic Marriage of Saint Catherine*, 1537. Oil and egg tempera on poplar panel (visual identification), 2560 × 1805 × 20 mm thick. Property of the Marquess of Northampton. Before treatment, front with frame rubs along the curved edge (a); back (b); and a diagram of reinforcements and splits viewed from the back (c). Some splits were initiated or aggravated by screw tips protruding from the framework and into the panel back in the lower right corner, and especially by a cross-grain insert at the middle of the bottom edge, where the splits zigzag abruptly.



a



b

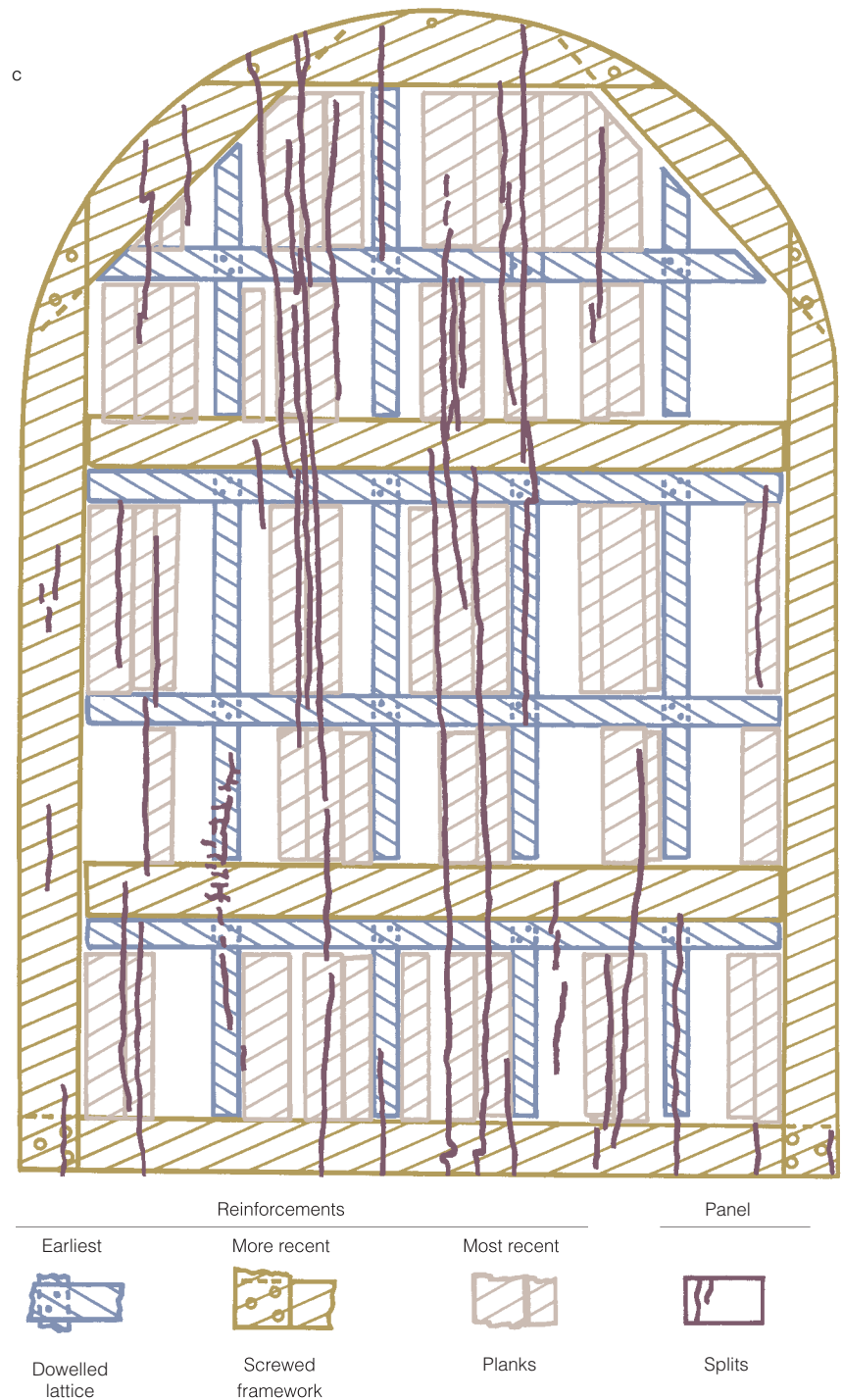

planks joined parallel to the longer edge, decreasing the work necessary for assembly.¹³ *The Visitation*¹⁴ by Tommaso Manzuoli (Keith 1994) and the *Transfiguration* by Raphael are both large by any standard. Most of the vertical planks of the Manzuoli are extended and consist of two planks joined end to end. In contrast, the planks of the Raphael are remarkably long, and they are not extended.

Large panels in portrait format with horizontally disposed planks are more prone to structural problems. Greater and more concentrated weight and greater warp movement provoke damage. For example, a large panel by Vittore Carpaccio,¹⁵ though still of approximately original

Figure 5a, b

J. M. W. Turner, *Story of Apollo and Daphne*, exhibited 1837. Oil on mahogany panel, 1100 × 1990 × 10 (bevel) to 20 mm (middle) thick. Tate Gallery, London. Front (a) and back (b) of a large panel consisting of a single mahogany plank.



a



b

thickness, shows considerable joint damage. Despite these observations, Figure 6a–c shows a painting by Rubens in King’s College Chapel, Cambridge, that has planks joined horizontally in portrait format. It is in very good condition. The oak planks are of original thickness; this has preserved the original joint surfaces and minimized wood movement so that the panel has remained flat overall.

In “landscape” format, horizontal planks perform better. Joint strength is increased by greater surface area, and the panel’s center of gravity is lower.

Handling of larger panels

In combination with greater weight, *the ratio of cross-grain dimension to thickness* is usually large enough to give larger panels a greater tendency to bend when handled or inadequately supported. In other words, for a constant thickness, panels that are larger across the grain become more prone to bending and subsequent damage. All panels bend when handled, though bending is not always perceived. Sound panels may withstand considerable bending stress.

Restraint considerations are more acute for larger panels, because of greater total movement, greater potential leverages, and weight effects. Restraint of moisture-dependent movement, such as that imposed by restrictive framing or reinforcement structures, can increase stresses. A statically restrained panel may be under considerable stress. Momentum—also a greater factor when heavier panels are handled or transported—should be



a

Figure 6a–c

Peter Paul Rubens, *The Adoration of the Magi*, seventeenth century. Oil on oak panel, 3280 × 2465 mm; original thickness unknown. King's College, Cambridge. Front (a); one of three vertical battens of the original auxiliary support (b); and an original iron cleat (c). Note the channel cut in the batten (c) to allow panel movement across the grain (vertically); the upper horizontal line is a joint. The panel has been maintained in a large interior space under relatively stable conditions. Disjoints along the side edges extend relatively short distances inward and stop near or at the first vertical battens. They had been treated with inserts or bridges. The battens, which are of relatively small rectangular section, do not appear to have caused excessive restraint, since the nailed cleats remain relatively unaffected.

considered in relation to potential stresses, whether a panel is restrained statically or allowed to move more freely.

Common sense should dictate precautions in handling. People with experience in panel structural work tend to rely on a “sense of feel” when handling a panel or judging its strength. This sense is probably a combination of experience, touch, and a keen attention to and awareness of the physical nature of the object. Inexperienced or careless handlers may be overconfident or, conversely, too cautious.

Therefore, when larger panels are moved, it is better to have at least one person present who is experienced in handling such objects. Two or more people are needed to move larger panels any distance. Coordination is important, because it is difficult to sense and maintain a constant share of the weight. A person on one corner of the panel may allow that side to droop, thereby causing a dangerous bend or twist.

Most wood is much weaker in the cross-grain direction. Strength in axial tension is up to fifty times greater than in tension perpendicular to the grain (Tsoumis 1991:162). If a panel is moved toward the horizontal, its weight should not be supported only at the side-grain edges¹⁶ or only at the middle of the end-grain edges. In the first situation, the weight causes sagging of the middle. In the second, the sides sag. In both cases, the panel must be structurally sound (i.e., no major defects) to withstand cross-grain bending safely. To support and balance weight better in the stronger axial-grain direction, greater support should be given along the end-grain edges, primarily at about one-quarter to one-third the distance from each corner. Further support may help decrease stress.

Panels in a vertical position are usually handled by the sides, which are usually the longitudinal-grain edges. This happens with larger panels because people must usually stand at the sides to lift. If the panel is tipped to lie horizontally, then the grip can be shifted to a better position at the end-grain edges to avoid the bending stresses discussed above.

If it is necessary to move a large panel from one edge to another, it is safer to lower it to a horizontal position and then to raise it again onto

the desired edge rather than to “cartwheel” the panel from one edge to another. When leaning a large panel away from a vertical position, it is also important to stop the bottom edge from sliding out. Weight directed at an angle to the floor can cause uncontrollable slides.

The greater mass of larger panels creates greater inertia, so rapid movements increase the likelihood of bends and twists. Twists or torsions cause stresses from many angles and are probably the most dangerous possibility (Gordon 1978:chap. 12). In describing the twisting of plates in relation to thin wooden panels, Bodig and Jayne have noted that a body in pure torsion is in a state of pure shear stress that is concentrated at the upper and lower surfaces (Bodig and Jayne 1982:165). Essentially, when a plate sustains a twist, one pair of diagonally opposite corners are forced closer together, while the other two corners are forced further apart. Boxlike structures or diagonals resist these distortions more efficiently, and they have been employed in some original reinforcements (Marette 1961:pls. 22, 23; Castelli and Ciatti 1989:142–43).

Twists can occur even with seemingly robust auxiliary supports, such as thick battens. The additional weight of the auxiliary support can increase the danger, as it is usually supported to some degree by the panel itself. A thicker panel resists bending and torsion better.

It is usually better to carry large panels with the grain held vertically. They should rest on an end-grain edge and lean slightly away from the painted side. During handling, great care should be taken if panels are laid horizontally or on a longitudinal-grain edge. The momentum of movement is transferred more dangerously to a horizontal panel, while buckling may occur in the latter case. Over longer distances, well-supported trolleys alleviate stresses on panels and bearers (Fig. 7). It is important to have the route clear and to have the panel’s destination prepared for both breadth *and* height.

Temporary auxiliary supports

It may be useful to build a temporary auxiliary support¹⁷ if a large, weakened panel is to be moved frequently or treated extensively. Designs can be tailored accordingly.

Figure 7

A large panel being transported on a custom-built trolley, attended by qualified personnel (1987).



A Flemish oak panel of original thickness had two nonoriginal metal battens screwed to the back (Fig. 8a–c). Not surprisingly, the panel developed splits and disjoints. A chalky, weak ground, combined with restrained wood movement, had caused tented flaking and losses. The battens were removed to prevent further damage while the painting awaited treatment.

To remove the battens, the panel was laid horizontally for better control. There was concern that release of the battens might cause a sudden warp movement and precipitate further flaking. A temporary framework was built to allow the panel to assume an unrestrained shape, as well as to provide support, improved access, and secure handling (Fig. 8d).

Wood may be preferred for such temporary supports, since a basic framework can be built quickly and easily. An adjustable, reusable, and therefore economical alternative was built from wood and right-angled-section metal girders, slotted for bolted assembly.¹⁸ A smaller honeycomb-core panel was bolted to the middle of the framework to preserve some access from below and to decrease twist.

Adjustable levelers, made from machine bolts threaded into brass plates, were attached to the framework crossbars in a regular pattern (Fig. 8e). The levelers were turned against flexible wooden battens that conformed to the panel back. As the metal battens were removed, the levelers were periodically readjusted to maintain contact as the panel changed shape. Fortunately, little movement occurred in this case, but the screws were readjusted periodically as the panel equilibrated.

This type of metal girder can be used for several purposes, such as the trolley shown in Figure 7, which was later used as a “trolley easel” to support a large panel for treatment. The pair of rubber wheels at one end swiveled. A central pair was fixed to roll parallel to the longer trolley axis to allow easy maneuvering in any direction.

Mobility of such temporary supports is useful, especially in a busy studio where large paintings must be moved often to allow photography, passage of other large paintings, and so forth. For stationary support, either the wheels were blocked, or the base was elevated slightly onto wooden battens or bricks. More rigidity could be had by doubling the girders or by adding more structure.

Two Examples of Large Panels

The structure and treatment of two large panels will be compared and contrasted because they show an instructive range of differences in period, place of origin, materials, construction, changes over time, deterioration, and conservation interventions. Their similarities show much about the structural behavior of large panels. An attempt has been made to relate the need for treatment, and some available treatment options, to the causes of deterioration. Some points specific to each case are included to emphasize the individuality that bears on treatment decisions. Though neither panel is typical, their mechanisms of change are similar to other cases. The paintings are referred to by the artists' names.

Figure 9a–c shows a painting by Anton Raphael Mengs (1728–79) on walnut (*Juglans regia* L.) that was completed in 1771 for the chapel of All Souls College, Oxford.¹⁹ The use of wood of a relatively high density is slightly puzzling for such a large panel and, moreover, one that would have had to be transported from southern Europe.²⁰ Though the painting is now about half its original thickness, its original weight may be estimated to

Figure 8a–e

Ambrosius Francken I, *The Judgment of Zaleucus*, late sixteenth century. Oil on oak panel, 1795 × 2165 × 20 mm thick. Fitzwilliam Museum, Cambridge (inv. 781); HKI treatment no. 137. A large panel of original thickness, damaged by attached (non-original) metal battens, which restrained wood movement: (a) front, faced, before treatment; (b) back before treatment; (c) detail of back, showing metal batten and one split; (d) temporary reinforcement of metal frame and honeycomb-core panel, to decrease twist; (e) in one corner, an adjustable leveler bears on a flexible wooden batten, against which the panel was laid.



a

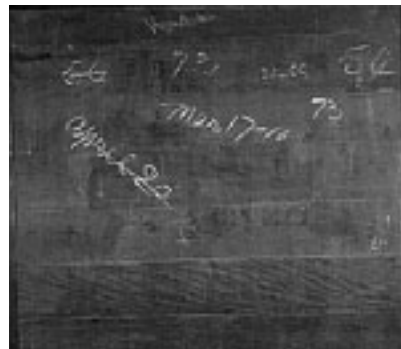

b



c

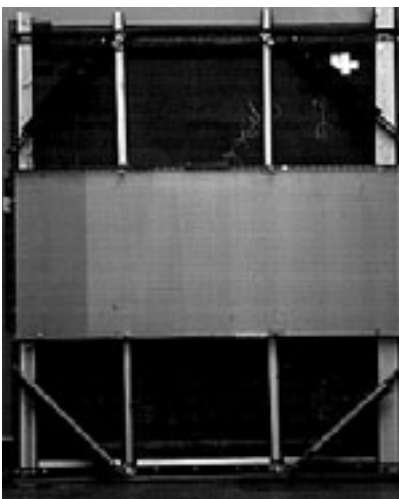

d



e



a

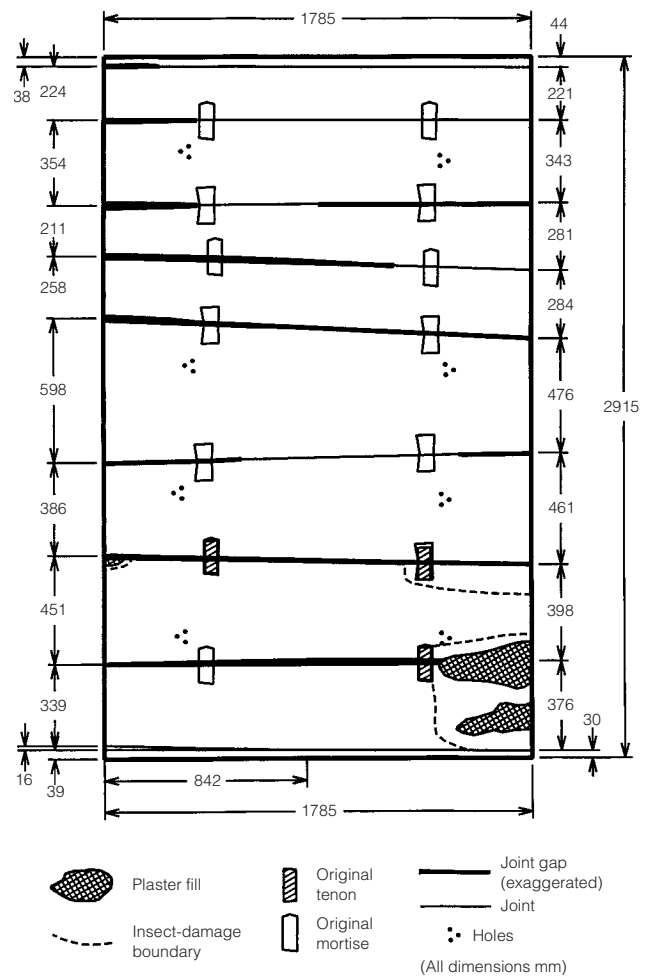

d

Figure 9a-d

Anton Raphael Mengs, *Noli Me Tangere*, 1771. Oil on walnut panel, 2915 × 1785 × 20 mm thick. All Souls College, Oxford. A large panel treated while lying on a side edge on a mobile temporary support: (a) front, before treatment, showing disjoints; (b) the front upper right of the panel, seen in top-raking light; (c) back during treatment, showing the last planks of the previous balsa laminate reinforcement (bottom) and the panel surface, damaged by thinning. The exposed mortises, the two remaining original tenons, and areas of insect damage and plaster filler can also be seen. Note the ratcheted polyester straps used to apply pressure during rejoining, and the vertical angle-sectioned beam used with veneer hold-down clamps to apply alignment pressure. A diagram of the panel construction (d) shows the tapered planks joined in reverse orientation and the irregular gaps (exaggerated) that developed after the panel disjoined.



b

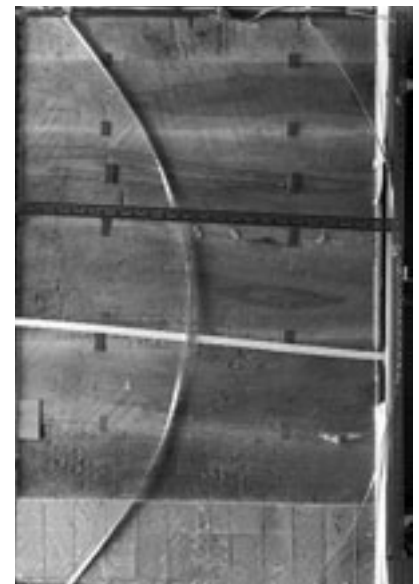

c

have been about 140 kg.²¹ Painted in portrait format, the substantial remaining weight and reduced thickness have had serious consequences.

The most recent conservation treatment, carried out in the 1960s, included thinning and reinforcement with a balsa laminate similar to that described by Lucas (1963). Subsequently, metal strips were added around all edges. Many of the panel's original joints later parted, presenting a precarious structure and dismembering the image both literally and figuratively. Structural damage made reappraisal of the painting's condition necessary as well, despite its recent restoration.

In contrast, a painting of 1537 by Marco Palmezzano (ca. 1458–1539) (Fig. 4a–c) with a lower-density poplar construction (briefly described above) arrived with the image greatly obscured by darkened varnish layers and surface dirt.²² Weakened in areas by insect damage, this panel had also been thinned to about half its original thickness, which weakened it further. A lattice of wood had then been glued to it, probably before it left Italy.²³ Undulations and compression damages attested to poplar's high capacity for bending and distortion under mechanical stress. Fortunately, the painting exhibited sound technique, a great advantage for structural conservation.²⁴

Both panels were assembled with casein glue. The joints of the Palmezzano had remained intact under stress, while the weaker, fibrous wood had parted into disconnected intermittent splits. Under stress, the stronger and more rigid walnut of the Mengs had remained relatively intact, while the joints had parted in the glue layer. These differences in fracture characteristics were due in part to the varying restraints imposed by the auxiliary supports. The wood of both paintings had fractured preferentially in insect-damaged areas.

More than thirty splits had developed throughout the Palmezzano, mainly from movement-restricting battens glued to the back. Some splits were older, with putties and aged varnish in the gaps, while others were obviously recent, with freshly exposed and fractured ground.

What factors led to deterioration of these panel paintings? Both panels may be examined more closely to understand the effects of structure, age, and past treatments on their condition.

Supports

The Mengs consists of six broad walnut planks arranged horizontally with respect to the image and joined in reverse orientation (Fig. 9d).²⁵ The bottom consists of two additional pieces: a narrower plank at the extreme edge, joined to a narrow, wedge-shaped strip. The wedge was used to square the bottom edge in relation to the taper of the lowest broad plank. At the extreme top edge, there is a similar narrow plank but no wedge.

Evidence shows that the panel was originally about 40 mm thick, twice its current thickness. The mortises and loose tenons had been uncovered by modern tools during the most recent thinning. The mortises had been chiseled into the joint faces to within 8 mm of the front of the panel²⁶ so that if originally centered, they would have left the same thickness of 8 mm at the back. The tenons²⁷ were not butterfly inserts, set into sockets cut into the panel back, as a superficial assessment of the exposed panel back might suggest. Thinning had also exposed remnants of original nails driven into the top and bottom edges, probably to secure the strips. These would have been driven near the center line of the original edges.

One of two original rectangular beech wood (*Fagus sylvatica* L.) inserts, visible on the front, had been exposed in an empty mortise at the back (Fig. 10a, b). The insert had been used to replace a wood defect. The adhesive did not appear to be casein, as was used to join the planks, but animal glue.²⁸ Where visible within the larger gaps, the joint faces had been inscribed with shallow Xs, either for adhesive tooth (which seems unlikely) or perhaps to ensure adequate glue pickup from the brush.

From the evidence then, the procedure for joining was as follows: the joint surfaces were planed; regular Xs were carefully inscribed into each surface and mortises were chiseled; one end of each tenon was glued with casein into one of the mortises of one plank;²⁹ the same glue was applied to both joint surfaces and to the protruding tenons; the planks were pressed firmly together and possibly rub-joined,³⁰ since the glue lines are relatively thin and do not appear to have dried in a “starved” condition. After drying, the desired height dimension was achieved, and the edges were squared with narrower strips, nailed and glued to top and bottom edges. The sides were trimmed square and straight.

Similarly, the Palmezzano would have been about twice its current thickness. Again, as with the Mengs’s tenons, poplar dowels were used to maintain rough alignment during assembly, and then the edges were finished. Thinning had exposed some dowels. Also similarly, long spikes remained that would have been driven straight, and with evident skill, near the original midline of the side edges.

Insect damage

Larger panels have proportionally greater expanses of insect-prone wood. Practical construction from whole planks would have favored greater plank widths. For economy and practicality, critical edges of sapwood were sometimes left in longer planks, partly because the transition line between heartwood and sapwood is irregular for some types of wood used for panels, such as the walnut and poplar used here.

Nearly every plank of the Palmezzano had variable, discontinuous lengths of damaged sapwood.³¹ In more central, critical areas, the damaged

Figure 10a, b

Anton Raphael Mengs, *Noli Me Tangere*. On the back, an original beechwood insert (a) in the walnut panel can be seen through an exposed mortise. The same insert viewed from the front (b) before treatment and in top-raking light.



a

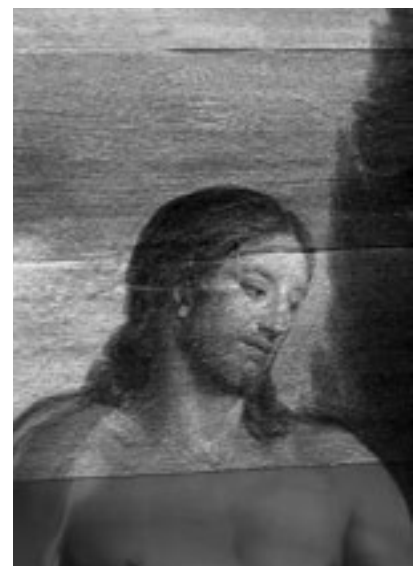

b

wood was replaced with inserts of linden wood to within 2–3 mm of the ground. No obvious adverse reactions to consolidation or wood replacement appeared after three years of observation. The apparent stability may partly be due to poplar's ability to accommodate stresses because of its resilient, fibrous, low-density structure.

Intermittent areas of damaged sapwood also occurred along some joints in the Mengs. Large wood losses had occurred at the bottom left corner (viewed from the front) (Fig. 11a, b), and plasterlike fills had been made, extending through the panel's thickness.³² The paint overlying the surrounding damaged wood had blistered into foldlike undulations in some areas. This damage was probably a result of compression from the panel's weight, possibly aggravated by setting and swelling of the wet plaster. Despite these adverse effects, the plaster was strong and well keyed. Its contact surface was well dispersed, which probably helped to spread stresses.

Intermittent insect damage occurred over the remainder of the panel, but in general this damage was not a serious structural threat and required no treatment. However, the substantial loss at the bottom corner, covering nearly one-third of the panel's width, represented weakness in a vulnerable area. Thinning had concentrated the entire panel weight onto a narrower cross section, one-third of which was weakened by insect damage. Some provision for added strength was considered necessary to provide adequate support and prevent further loss and damage to the large area of paint overlying the damaged wood. Walnut inserts were fitted.³³

Figure 11a, b

Anton Raphael Mengs, *Noli Me Tangere*. Top-raking light shows an insect-damaged area in the lower left corner of the front, surrounding a plaster fill. Note the undulations, probably from compressive strain from the panel's weight. The same area seen from the back (b) in normal light.

Interactions of thinned panels and nonoriginal auxiliary supports

Obviously the Mengs was a heavy panel while still in its original state. Display, handling, and transport called for adequate reinforcement. Horizontal joints could be advantageous, since gravity would tend to keep them together in compression. Standing vertically, however, destructive

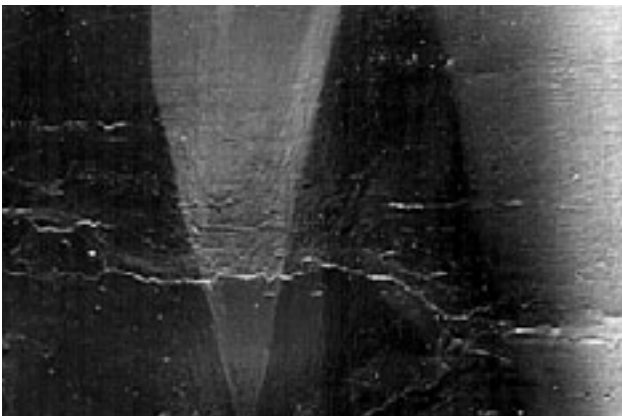

a



b

bending stresses would be more likely, imposed by considerable leverages. Any warp from a flat plane would promote buckling. Such a buckling tendency would pose a long-term bending stress across the joint axes, a condition greatly exacerbated by thinning.

Evidence of a previous, perhaps original reinforcement exists as eight sets of three holes each, spaced at regular intervals across the panel back (Fig. 9d). It was unknown what form this reinforcement would have taken. Had documentation of the panel back prior to the recent thinning been available, it may have provided evidence to help with subsequent treatment decisions.

By contrast, the structure of the Palmezzano is more logical. The chosen wood is lighter, with the planks disposed vertically. Thus, the wood bears weight in a more natural orientation, analogous to its mechanical role in a living tree. With the grain vertical, buckling would be a negligible concern, even with the panel half its original thickness. Therefore, weight does not combine with movement across the wood grain to threaten the Palmezzano's structure as much as in the Mengs.

The Palmezzano had no evidence of original auxiliary support.³⁴ At least four different types of battens had been applied at various times over the long period since the panel was last thinned. Finally, remedial action took the form of short planks glued over developing splits, including old stretcher members taken from paintings on fabric. Eventually the panel became choked with stopgap solutions. These additions induced severe distortions, splits, and compression damage concentrated in the panel's center. Centralized damage occurred because overall reinforcements tended to concentrate bending stresses toward the middle. This factor then combined with tension and compression stress overall caused by restraint of lateral movement.³⁵ The pattern of splits shows how stresses were interrupted over the cross-grain battens (Fig. 4c).

Also, putties (or fills) had been applied to splits that had not first been rejoined. This and subsequent wood movement caused compression stress and distortions in the adjacent paint. Such disfiguring damage is neither easily nor totally reversible. It is better not to put fillers into surface cracks if effective structural work is not done first to underlying splits.

For both panels, attempts to flatten and reinforce them have instead tended to weaken them further. Such treatment efforts are examples of excessive, damaging measures that have been used to meet reinforcement requirements of some large panels, as well as to serve aesthetic purposes. The resulting deterioration of paintings *with* supports shows that those requirements must be better understood, and they must be achieved with better methods that maintain the integrity of the panel painting.

The consequences of thinning a large panel can be critical, mainly because a heavy weight must then be supported by a structure made relatively weak while still allowing for adequate wood movement under variable conditions. It is worth examining the motivations for thinning, which have particularly serious implications for preservation of larger panels. In general (and leaving the question of transfer procedures aside), panels may have been thinned for several reasons, including:

1. the mistaken belief that thinning reduces the tendency to move and warp in response to changes in MC (the reverse is true);³⁶

2. to flatten and smooth the back surface, a procedure usually followed by the attachment of battens or laminates to restrain the panel in a flattened state;
3. to lighten the panel for easier handling or transport (which may also have the opposite effect because of increased fragility);
4. simply to take action.

It could be tempting to lighten large, heavy panels such as the Mengs. From a strictly practical viewpoint, sheer size would be reason enough for cutting away some wood to provide a flat surface to more easily fit a new auxiliary support. To respect and conserve the *entire original object*, however, it is possible, for example, to build up an even surface of balsa wood for battens to bear upon (Buck 1962) without removing original panel wood to achieve the same purpose. The three remaining reasons cited above for thinning are unjustifiable with respect to preservation.

The most recent thinning of the Mengs panel appears to have been directed at obtaining a flat surface to allow adhesion of relatively large balsa planks. The use of power tools is evident from the parallel kerf marks of a circular saw, power-planer blade marks, gouge marks chipped deep into the irregular walnut grain, localized rasp marks, and other damages.

Despite the large scale of work that seems to justify the use of power tools on larger panels, the use of manually controlled hand tools is preferable. Some power tools are “double-edged swords” that can speed work but also easily outstrip the intention and control of the user.³⁷ A higher speed of treatment, for whatever reason, should not endanger the painting. In this regard, responsibility for the *rate* of treatment and its effects extends beyond the conservator to all custodians of cultural property—administrators, curators, dealers, and owners.

In an effort to prevent buckling of the Mengs, strips of slotted metal had been screwed into the edges of the panel and balsa laminate (Fig. 12). Obviously, even though cross-laminated, balsa did not prove sufficiently rigid to prevent buckling when the panel was upright. The metal edging provided a relatively rigid outer framework that met the immediate reinforcement need but that had serious consequences for the painting.³⁸

Unrestrained, the panel would expand and contract as a unit, the top moving upward and downward with changes in MC. With such a large panel, lateral movement across the wood grain could be on the order of 50 mm, if fully equilibrated over a 30% change in RH.³⁹ However, the entire panel could not move as a unit. Instead, the planks were individually constrained to expand and contract around the wood screws at each end. At lower humidities, the panel would contract across the grain, and either the wood had to split or the joint adhesive had to give way, depending on whichever was weaker. Though casein is normally a strong adhesive, the walnut wood was stronger, even across the grain, so the joints failed in tension across the adhesive layer. They probably opened catastrophically, as zippers sometimes do, especially if the panel was subjected to relatively rapid and large changes in RH.⁴⁰ One joint near the center of the panel had completely parted.

Environmental history affects the stress distribution in wooden panels.⁴¹ Seasoned planks develop a particular stress distribution before being assembled. Once the planks are joined, grounded, and painted on

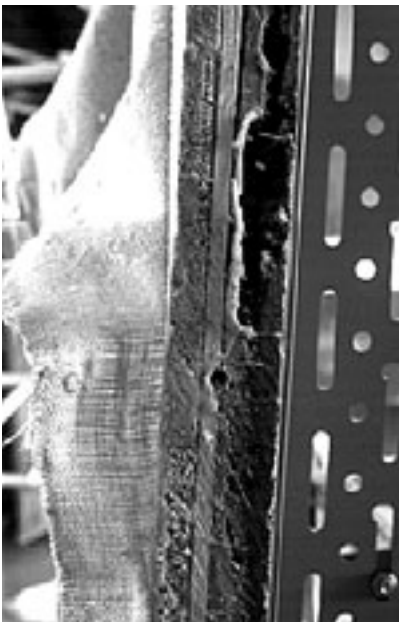

Figure 12
Anton Raphael Mengs, *Noli Me Tangere*. Screw holes in the panel edge where metal reinforcement strips were attached. The panel is on the right. Note the layers of balsa/wax-resin and fabric laminate and the saw marks in the panel where the balsa was carelessly trimmed.

one side, a *different* overall stress distribution develops that depends on environmental interactions. With larger panels, the total (elastic) stress in the panel structure is accordingly greater.⁴²

For the Mengs, the combination of thinning and disjoining appeared to have reduced the physical equilibrium of the individual planks. Once disjoined, they responded to the internal stress with deformation. The plank edges at the joints, originally parallel, became contoured to the irregular grain direction of their respective planks. Thus, the joint gap varied by millimeters along some disjoined sections (Fig. 9d), and the joint faces no longer met continuously or squarely. Such potential damage from wood's reaction to stress release should discourage the thinning of panel paintings.

During the rejoining process, wood inserts were fitted to the gaps so that no original wood was removed.

Treatment considerations

Planning is important for any large panel treatment. The order and choice of treatment steps should be logical in relation to the treatment as a whole and should not foreclose later treatment options. The greater scale of treatment for large panels usually makes backtracking difficult and costly. A cautious, considered approach, in which each stage is tested, should be adopted.

As an example, radiographic examination of the Palmezzano did not reveal enough of the condition of the wood, prior to treatment, to ascertain the full extent of damage, since the battens were obscuring the panel wood. The possibility that the panel might require extensive wood replacement was anticipated with a more thorough facing than the panel's apparent condition warranted. Halfway through a batten or cradle removal, with splits all around, one cannot easily move a large panel to apply a facing that should have been anticipated earlier.

Photodocumentation is important for the back of the panel, as well as the front.⁴³ It is therefore necessary to have larger panels disposed so that necessary photography can be done at any treatment stage. Even with the best photographic resources, adequate space is required for the necessary distances and angles. Also, large panels invite strong lighting, especially for overall photographs, so heat effects should be considered (Wolters and Kühn 1962). Short-duration electronic flash units have a less drying effect than the heat associated with continually lit tungsten lamps.

Though not easily achieved, relatively constant humidity should be maintained to minimize stresses from warping movements during treatment. Rejoining can take days for larger panels because thicker joints and less-absorbent, higher-density woods require longer drying periods.

It is sometimes better to allow sufficient time for the panel structure to equilibrate during treatment, to avoid stress that might precipitate damage. When the Mengs was rejoined, for example, the balsa reinforcement was removed in stages between which the exposed panel was allowed to equilibrate to a more stable curvature (prior to rejoining) unimpeded by restraint caused by the reinforcement or its moisture-barrier effect. If rejoined before equilibration, joints could fail again prematurely.

It is possible to manipulate humidity to facilitate some procedures. Larger panels especially can bind or "lock" sliding reinforcements because of greater total movement and rigidity. It may be possible temporarily to raise or lower the humidity slightly in order to loosen sliding

members of cradles for easier removal, for example.⁴⁴ This procedure could prevent greater stress to the painting from unnecessary tool work.

Structural treatments of large panels make great demands on a conservator and can take a long time. Assuming that they have equal abilities, one conservator usually takes at least twice as long as two, and the demands on stamina are doubled. A team benefits from improved safety and morale, and its members can help one another in making decisions, thereby achieving quicker and better results.

Access and control

Easy access is an advantage for structural work. Access is more difficult with larger panels since the conservator must move around the panel. If the panel is horizontal, the conservator must find some means of reaching the work area, which is often in the middle of the panel. It is important to establish a comfortable position, since the work may be of long duration or require sustained precise and safe manipulation of tools (Fig. 13).

Horizontal support of such a large, thin, heavy panel as the Mengs presents some problems with regard to treatment procedures and stress distributions in the panel during extensive, prolonged structural work. Concern arose that warp movement would be restrained by the panel's own weight if it were laid horizontally, causing detrimental bending stress.

It is difficult to judge the effect of such warp restraint, especially in larger panels. For example, it was anticipated that once the balsa and wax-resin were removed from the Mengs, a different curvature would ensue. Laid horizontally, the panel would almost certainly have warped away from a table surface. The suspended weight would have caused bending around the supporting fulcrum(s), with a risk of breakage at the weakened joints or in worm-damaged areas. Therefore, it was considered undesirable to treat such a panel horizontally before adequate structural consolidation was achieved.

Alignment and rejoining are generally more difficult for larger panels than for smaller ones. Suitable temporary supports and apparatus must be available for operations such as rejoining. The approach must

Figure 13

The conservator, left, kneeling on a bridge used to gain access to the back of a large panel laid horizontally for structural treatment of the wooden support.



meet the relative complications of treatment and may also take advantage of the panel structure itself.

Based on these considerations, the Mengs was placed on a side edge with silicone paper and a length of pine batten beneath. The main reason for standing the panel vertically was to make access to both front and back possible during structural work. This approach (which is not a new concept) is practical in some cases.⁴⁵ To minimize restraint and allow the panel to adjust position, it was occasionally lifted slightly at one end.

The relatively straightforward rejoining problem of the Mengs was especially suited to a vertical orientation. The Palmezzano, in contrast, had a high number of fragmented splits and generally more complicated treatment demands, which made a horizontal orientation preferable. A padded support table and rejoining apparatus were designed and built to allow all-around access and control.

Ideally, to improve access and stabilize the panel before rejoining, all moisture barriers and restraints, including unnecessary and nonoriginal glue layers,⁴⁶ may be removed to allow the entire panel structure to stabilize. This measure may not always be possible with larger panels, where equilibration may have to be limited to the general area surrounding the wood to be treated. It would have been difficult to treat either panel safely with all previous restraints removed, though such a proposal would be more feasible for smaller panels (Brewer 1994b).

In some cases, advantage may be taken of the immobilizing effect of previous reinforcements during their removal to maintain some structural stability while rejoining large panels. Working from the proper top of the Mengs, the balsa laminate and most of the wax-resin were removed from each successive plank pair to be rejoined, leaving the remainder still covered and the next disjoin still bridged for stability. Each freshly exposed plank pair was then left undisturbed for at least one week to allow some equilibration of the panel's curvature before rejoining. This approach maintained greater stability while allowing adequate joining pressures to be applied without disrupting the remaining disjoints.

Battens were removed similarly from the Palmezzano (Fig. 14). This was done by working across the panel grain and reducing the battens

Figure 14

Marco Palmezzano, *The Mystic Marriage of Saint Catherine*. The panel laid facedown on a padded table during the initial stages of removal of the previous reinforcements. The tools are on the chair. Note that the removal was begun from a side-grain (nearest) edge and progressed across the panel grain.



in a step-by-step manner while leaving them intact over and beyond the next split. For larger panels, which may tend to move substantially on release, a cross-grain direction of removal may be adopted. The panel can move and warp more freely across the wood grain, with less chance of twist than if removal proceeded irregularly or from an end-grain edge. A hand-pressured chisel (no mallet) and a dovetail saw were the only tools used.

Curvature effects and rejoining of larger panels

The convex warp (viewed from the painted side) in many panel paintings is largely due to the development of compression set (Buck 1972:2), as shown by both panel examples.⁴⁷ Both were rejoined with respect to the set warp assumed by the planks after removal of the reinforcements. Several methods might be considered to reduce such warp and maintain the panel in a safer, more planar configuration. Though usually done for aesthetic reasons, this would also lessen the panel's tendency to buckle under its own weight if the planks are disposed horizontally.

In the author's opinion, set in the wood of panel paintings is not practically reversible as yet, especially in larger panels, because most methods involve extensive intervention to the wood or have uncertain long-term effects.⁴⁸ Raising the ambient humidity provides only a temporary reduction in warp, because the effect of set warp in a panel equilibrated to one humidity returns if the panel is placed in a higher humidity and allowed to fully equilibrate. The impression of an apparent reduction in warp from raising ambient humidity is especially evident with larger panels because of their greater total movement. However, most observers do not have the opportunity to monitor long-term changes in larger panels under controlled environmental conditions until an equilibrium curvature is established.

Other methods of warp reduction are possible. As the Mengs required extensive rejoining, V-shaped inserts could be used in the joints to counter the curvature of the planks and achieve a relatively flat panel (Fig. 15). This method has been used for panels of all sizes, sometimes for aesthetic reasons. However, a gentle overall curvature may be less disruptive to the appearance than the resulting "washboard." Photographs before and after structural treatment of the Palmezzano, in raking light, may be compared in this respect (Fig. 16a, b).

Insertion of wedges for the purpose of flattening the panel may be considered as a last resort, whether for structural or aesthetic purposes. Acceptable flatness is partly an aesthetic concern, of course. In general, however, it may be preferable to respect the current overall curvature, as determined by the original panel structure and aging effects, to preserve intact joints and the painting in unaltered form. Panels that are partially disjoined or split, such as the Mengs, would require either breaking the remainder of the fractured area, with serious risks to the overlying and adjacent paint, or inserting wedges into the parted areas as desired. Additional stress would be imposed on the remaining intact joint or sound wood as flattening pressures were applied. From an ethical standpoint, such an option for flattening is more practical and possibly more acceptable for a complete disjoin.

For both panels, the above options for flattening would all involve protracted and serious risks. Finally, breaking of a partial disjoin having original, intact paint above is an important ethical issue. In consideration of these points, the set warp and its ramifications were accepted in the

Figure 15

South Netherlands, *Triptych of the Holy Family and the Trinity*, ca. 1510. Oil on panel, 1500 (center) × 1500 × 15 mm thick (visual estimates). Wallraf-Richartz-Museum (INV WRM416), Cologne. An altarpiece consisting of oak planks rejoined with V-shaped inserts of oak, probably to reestablish an overall flat plane after the planks developed set convex warps (viewed from the front).



Mengs and the Palmezzano, and they were conserved within the limitations of their current structure and condition.

Though disjoins in smaller panels may be glued and rejoined in one operation using appropriate apparatus, larger breaks take more time, so that glues tend to set, or “go off,” earlier than desired. The procedure must be well prepared if time is a factor (see Brewer, “Some Rejoining Methods,” herein).

Alternatively, using inserts, the conservator may rejoin a long joint progressively by working along it in discrete stages.⁴⁹ If this method is used, it is important to ensure correct alignment in all three dimensions from the beginning. If the relative positions of the joint faces have been incorrectly aligned and fixed in the early stages of rejoining, they may

Figure 16a, b

Marco Palmezzano, *The Mystic Marriage of Saint Catherine*. The painting, in raking light on the left, before structural work (a) and after structural work and before retouching (b).



a



b

converge or diverge as the other end of the joint is approached. Slight corrections may be made by bending softer woods back into alignment at later stages, but some distortion and stress are then built in as well.

Auxiliary support of larger panels

Despite such rare examples as the Turners mentioned above, larger panels generally have substantial reinforcements (Fig. 6b, c). A higher ratio of cross-grain dimension to thickness becomes a greater concern with large panels of higher wood density. The structural implications can be greater for certain panel structures, such as those with horizontal planks. Even with sound joints, the Mengs tended to buckle under its own weight if stood on its bottom edge. Most of the wood was sufficiently sound and strong to withstand even quite severe bending stresses, but the joints will always be weaker.⁵⁰ When there is already a set warp, buckling tendency worsens as the panel warps further out of plane because of humidity fluctuations. Such fluctuations would aggravate buckling even if the panel were relatively flat at a particular humidity.

So, with reference to these concerns, the final and most challenging difficulty, as with many large panels, was supporting the Mengs in an upright position without restricting movement too greatly. The disjoints, the inadequate balsa laminate, and especially the metal edge strips were no surprise considering the panel's structure, weight, and thinned state. The critical point, however, is that a relatively rigid form of reinforcement is necessary nonetheless for such large, thin, heavy panels, and the panel structure must be sufficiently sound to take potential stress without rupture.

The Palmezzano is also a good example of a large, thin, weakened panel requiring overall reinforcement of a specialized type. Internal fractures remain in many panels after structural treatment, partly because they are difficult to detect, even with radiography, especially in fibrous, lower-density woods such as poplar.

The inherent weaknesses of panels such as the Palmezzano cannot be overemphasized. A sympathetic but effective auxiliary support is necessary in such cases. Truly satisfactory reinforcement designs with proven effectiveness are still being sought for panel paintings of this nature, as evidenced by the increasing amount of literature on new and modified reinforcement designs.⁵¹

When this article was written, an auxiliary support was being designed and tested for the Mengs. It is therefore not presented here. However, an auxiliary support applied to the Palmezzano is described. The support was designed to allow greater movement, reduce the risk of further splits and damages, and give adequate reinforcement.

The design is based partly on those developed at the London studio of the HKI (Fig. 17a–c) (see Bobak, "A Flexible Unattached Auxiliary Support," herein; Marchant, "Development of a Flexible Attached Auxiliary Support," herein; Brewer 1994c). So far it is the largest version that attempts to realize the main principle of tailored flexibility. Horizontal tapered battens and a peripheral frame were constructed from Sitka spruce (*Picea sitchensis* [Bong.] Carr.), and oak uprights were attached to the horizontal battens to form a supporting lattice. The horizontals were dovetailed into the peripheral frame for strength during handling. The peripheral frame extended beyond the edges of the painting, and a surrounding border of thick card projected up to 5 mm in front of

the paint surface (Fig. 17d), to protect the painting edges from careless handling and frame rubs (see Fig. 4a for damage from frame rubs).

The lattice was assembled with aluminum-reinforced joints and various fasteners of brass and stainless steel. It was made as lightweight as possible and was thinly constructed to facilitate framing. Because of its prototypical nature, it had to be capable of disassembly to any stage, a characteristic it retains. The battens were made of equal thickness and then tapered to adjust their flexibility to the panel's strength and potential movement. The bottom ledge of the peripheral frame was kerf-sawed for flexibility. Both battens and ledge were steam-bent to approximate the panel's overall deflection when equilibrated to about 60% RH.⁵²

To attach the lattice, four vertical retaining strips were cut and positioned at regular intervals across the panel back. The strips were slid through retainers of poplar that were glued to the panel back. Potential stresses on the retainers were spread locally with baseplates of poplar.

Figure 17a–d

Marco Palmezzano, *The Mystic Marriage of Saint Catherine*. After treatment, showing the back (a) with reinforcement attached; the retaining strip (b), with its stepped profile, being slid upward one “step” for removal; the same area with the strip removed (c), showing the retainers and baseplates and the tapered battens next to the panel surface; the lower left corner of the front (d), showing edge protection and the bottom ledge, which is kerf-sawed to increase its flexibility.

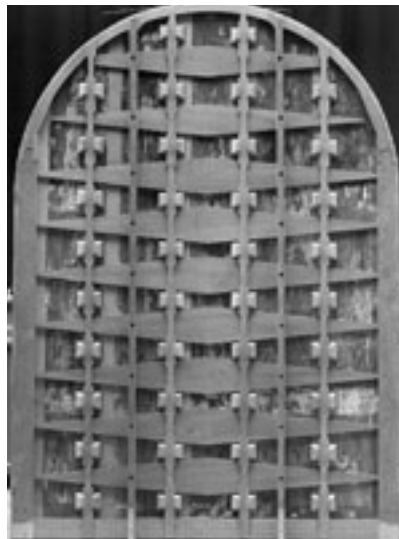

a



b

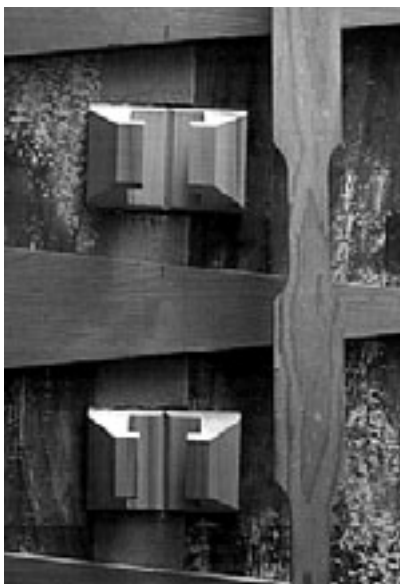

c

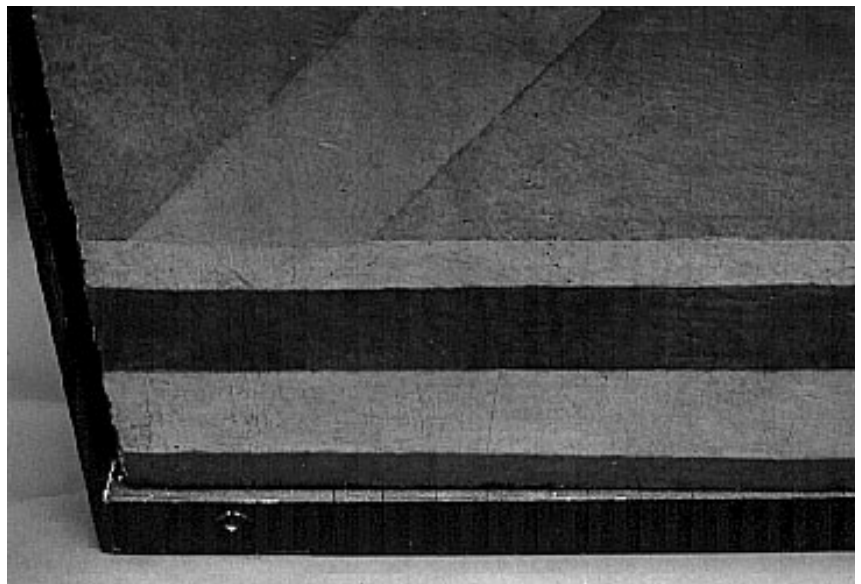

d

The choice of positions for the retainers was based partly on a regular distribution across the panel and partly on the location of relatively flat gluing surfaces.

Normally, the removal of sliding battens from a panel requires a space of twice the batten length. The required space was twice the panel's height in this case and made a modified means of removing the retaining strips desirable. It was possible to narrow the strips at intervals equal to the vertical distance between the retainers. This allowed the strips to be placed directly against the lattice battens (Fig. 17b, c) and between the retainers; they were then slid down and engaged in a functional position.⁵³

Built thus, the structure provided adequate reinforcement while it was still flexible enough to bend with warp movement. This reduced the risk of restraint of lateral movement by friction and locking. It protected the edges against mishandling and accidents. While attached, the structure still permitted examination of much of the panel back. Most of the structure could be quickly removed to access all of the back surface except beneath the retainers. The retainers could be removed mechanically with relative ease because low-density wood was used. The glue used to attach the retainers could be easily swelled with water and removed with spatula and swab.⁵⁴

Since the structural work was completed, the panel has been monitored for at least two years to determine the effectiveness of the reinforcement and other aspects of the treatment. Due to RH variations, changes in deflection at the middle (in relation to the side edges) have been measured at up to 30 mm—about half the deflection that was observed under a similar RH range when the panel was structurally consolidated but not reinforced. The two central retaining strips have shown increased friction as the panel has become more convex (viewed from the front), but lateral movement has not been excessively constrained, as occurs frequently with more rigidly battened or cradled panels of this nature.⁵⁵ The panel appears to be adequately reinforced and moves without any obvious detrimental effect.

Framing, hanging, and transit

Old wooden panels are continually subject to movement—probably nearly as much as when they were first painted (Buck 1952; Laurie 1967:55; Klein and Bröker 1990; Mecklenburg and Tumosa 1991). Therefore, allowance should be made in the frame for *potential* panel movement. Of course, excessive frame restraint would negate any capacity of the panel's reinforcement structure to allow for movement. Considerations related to the frame retention of panels are similar to those relating to auxiliary support. Many paintings do not remain in a relatively constant, well-controlled environment. Passive controls are not always sufficient, and active controls can malfunction in even the best-maintained buildings.

Therefore, an allowance must be made by sizing the frame rabbet for cross-grain expansion of the panel wood. Otherwise, a "bound-in-frame" condition occurs as the panel expands to press on the rabbet's outer walls. Also, it is important that framing not restrict warping movement with overly rigid retention. These stresses can easily break the panel or the frame (*Museum* 1955:159–60). Of course, competent framers allow space in the rabbet to avoid this possibility, but the degree of panel movement can be underestimated, especially in larger panels.

Whether or not they are framed, large heavy panels are probably better supported on a plinth or base rather than hung. In either case, but certainly if they are hung, a strong, rigid frame is an advantage for the protection of a larger panel—and not simply during handling. The panel painting by Mengs arrived in such a frame. In contrast, the framing of the *Palmezzano* was inadequate and detrimental.

When it arrived, the *Palmezzano* had a shallow, flimsy frame that was hung from the panel—instead of the sensible reverse arrangement that has the panel hung by its frame. The weight of both was concentrated on the panel by screw eyes set into one of the half-round battens of oak that made up the horizontal members of the glued lattice.

Large panels, especially, should not be hung from such reinforcements, because the weight is thereby converted to internal stresses on the panel wood. The weight of the panel, battens, and frame had put such a torque on the surrounding panel wood that a cross-grain tear was induced. This probably occurred slowly, over a period of years, since the thick overlying ground and paint layers, though broken, show considerable plastic deformation. Larger panels should be framed sturdily and be hung from the frame—certainly not the reverse. In consultations with the owner and professional framers, it was determined that a more suitable frame was urgently needed because of inherent weakness and the dangers of mishandling.

Though sufficiently strong, the rabbet of the Mengs frame was not deep enough to allow for any warping movement of the panel, so that the panel was, in fact, retained too rigidly. Before treatment this factor was rather immaterial because the metal edge strips allowed little movement in any direction. After conservation, though, the rabbet could be deepened, padded, and possibly profiled where it contacted the front to allow for inherent warp and potential movement. Rabbets shaped to the contour of the painted surface, or camber, at the panel edges help to spread the surface of contact between panel and frame, reducing localized stresses and friction. Abraded varnish and paint are more likely on larger framed panels because of greater movement and resulting friction. Profiling may also help aesthetically to decrease large visible gaps from the larger panels' greater warp movement.

During transit, larger panels should be supported to minimize the effects of weight on bending. Low-density foam may be secured around the panel to minimize bending from weight or shock loads while allowing some wood movement. Since a packing system can seldom conform to large changes in panel shape, the environment—RH, shock, and vibration, in particular—should be controlled, especially for large, thin panels (Mecklenburg and Tumosa 1991:190; Michalski 1991:241). For the transport of larger panels, reputable art professionals well versed in the proper precautions may be preferred. They should be accompanied by a qualified conservator, if possible.

Acknowledgments

Most described treatments were done while the author was an intern specializing in panel painting conservation at the the Hamilton Kerr Institute (HKI). Thanks go to the Getty Grant Program and to the Samuel H. Kress Foundation, New York, for funding the internship. Other treatments were completed while the author continued at the HKI, employed as a conservator and research associate, thanks to funding by the Leverhulme Trust,

London, and the Samuel H. Kress Foundation and the HKI. The author thanks Ian McClure for his support and, above all, for allowing him freedom in pursuing these treatments.

Notes

- 1 Transverse grain direction.
- 2 Changes in MC and moisture gradients in wood are the primary causes of wood movement. Skaar (1988:chap. 4) reviews the topic thoroughly. See also Panshin and de Zeeuw (1970:206).
- 3 Of course, wood movement as a proportion of cross-grain dimension (percent of movement across the grain) remains the same, no matter what the panel size.
- 4 This statement refers mainly to the changes in dimensions and shape that accompany an RH change prior to equilibration. Dimensions and shape at equilibrium also depend on such things as the proportion of tangential to radial wood, the set of the wood cells prevailing from past conditions, and the presence of preparation and paint layers that may influence mechanical restraint and the rate of moisture permeability.
- 5 The effect will be less if such a plank is positioned closer to the panel's longitudinal-grain edges.
- 6 For example, as RH rises, the uncoated panel back usually swells first in response to a rising MC. The expansion is resisted by the remaining panel thickness, which has not begun to swell. If that remaining thickness is less rigid, such as in thin panels or in woods of lower density, the force of swelling at the back will cause a deflection, producing a concave warp when viewed from the front. For the same wood density, thicker panels will be more rigid and therefore have greater resistance to the effect of the swelling.
- 7 Longitudinal permeability may be 1,000–10,000 times greater than transverse permeability (Panshin and de Zeeuw 1970:217).
- 8 Determined by microscopic examination of a cross section.
- 9 Raffaello Sanzio, *Transfiguration* (1517–20). Oil on cherry-wood panel, 4100 × 2790 × 45 mm thick (average). Vatican Museums.
- 10 Marette (1961:65–67) gives a frequency distribution by wood type.
- 11 Not shown, J. M. W. Turner, *The Opening of the Wallhalla, 1842*, exhibited 1843. Oil, wax, and resin on mahogany panel, 1130 × 2010 × 10 (bevel) to 20 mm (middle) thick. Tate Gallery, London (inv. N00533).
- 12 See an early use of American mahogany (*Swietenia* spp.) in two paintings attributed to Rembrandt's studio of the 1640s (Bruyn et al. 1989:668–78). Though not particularly large paintings, they are both on single planks and are therefore "large" examples in that sense. Moreover, the planks are from the same tree, and show rather "wild" (very irregular) figure, making them even more unusual.
- 13 The number of joints is smaller and the clamping spans are shorter and therefore less awkward.
- 14 Tommaso Manzuoli, *The Visitation*, ca. 1560. Oil on poplar panel, 4090 × 2485 × 45 mm (original thickness). Trinity Hall, Cambridge, England. HKI treatment no. 194.
- 15 Vittore Carpaccio, *Saint Thomas Aquinas Enthroned between SS. Mark and Louis of Toulouse, Adored by a Youthful Donor; (above) Virgin and Child with Angels*, 1507. Oil on poplar (?) panel, 2640 × 1710 × 30–40 mm thick (visual estimate by author). Staatsgalerie, Stuttgart (inv. 136).
- 16 Edges roughly parallel to the axial, or longitudinal, grain direction.
- 17 The panel itself is usually called the *primary* support, or simply the support. A *secondary*, or *auxiliary*, support may be defined as an original or later structure applied to the panel, whether attached or not, to provide overall reinforcement.
- 18 Also known as slotted angle, such girders are found in various forms in laboratories in many countries. They can usually be acquired in various flange widths.
- 19 HKI treatment no. 73. The painting is on a thin glue-based ground. The glue appears to be casein, judging from the color, hardness, relative insolubility, and swelling characteristics of a

ground drip at the edge. It is interesting to note, in relation to the origins of this panel, that Mengs was in a transition period at the time this painting was commissioned, having just arrived in Rome from Madrid via Florence (Roettgen 1993:30–32).

- 20 Such considerations did not stop others from using heavy woods for panels that were commissioned from afar. Though Rubens may be cited as an example, oak was the standard panel wood in northern Europe, so lighter woods would not have been commonly used there. Lighter woods, mainly softwoods and poplar, were more common in Spain and Italy, and therefore it is curious that walnut was used here.
- 21 Based on a density of 640 kg m^{-3} from Lincoln (1986:27).
- 22 Marco Palmezzano, *The Mystic Marriage of Saint Catherine*, 1537. Oil and egg tempera on poplar panel (visual identification), $2560 \times 1805 \times 20$ mm thick.
- 23 The earliest reinforcement lattice was glued to the thinned panel with casein, an adhesive common in Italian panels of that period (Marijnissen 1985:65) and less likely to be found as a panel adhesive in northern Europe in the same period. This observation was subsequently strengthened by research, kindly shared with the author by P. Balch. Known as the Calzolari Altarpiece, the painting was commissioned for the Church of S. Agostino in Cesena, near Palmezzano's native Forlì. The painting had been moved to the Ercolani collection in Bologna by 1776. Cavalcaselle saw it in England in 1860, stating that it appeared "damaged [and] comes from the Ercolani in Bologna" (*Quest'opera non molto bella e danneggiata pervenne alla Raccolta Ercolani di Bologna*) (Grigioni 1956:575). Therefore, it seems likely that the earliest lattice and some related damages are at least 120 years old, or probably nearly twice that age.

The lattice was constructed and then glued *as a unit* to the thinned, flattened panel. This was evident from the dowelled cross-halving joints of the lattice, exposed during removal. The dowels were set into tapered holes and finished flush on the unexposed side of the lattice.
- 24 This technique included a thick gesso ground and a combination of oil and tempera paint.
- 25 Most planks were cut to the taper of the tree trunk for minimal waste, and the topmost end of one plank was positioned beside the bottommost end of its neighbor.
- 26 Interestingly, the cutting direction caused by the bevel of the panel maker's chisel resulted in a distinctly butterfly-shaped profile in many of the mortises, when viewed from the back. Thus, it is now possible to mistake the mortises for original insert sockets of the butterfly type, with inserts set in from the back, a technique seen in some panels.
- 27 Loose tenons, probably of holm oak (*Quercus ilex* L.) were used to align the plank edges during assembly. Regarding origins, both woods could be found in Italy and Spain at the time. In Spanish panels, walnut is found mainly in panels from the regions of Navarre and Castille (Marette 1961:68). It is possible that the panel was constructed in Spain, the painting begun there by Mengs and finished after his move to Rome.
- 28 This observation was not tested chemically.
- 29 The tenons were fitted very loosely, with at least a 3 mm gap all around. Before the joining, the tenon glue may or may not have been allowed to dry. It is interesting that the fit is quite free, with little contact area, suggesting that the tenons were more for alignment in assembly than for joint strength.
- 30 The surfaces are rubbed together to thin the glue line until the increasing adhesive strength makes further rubbing very difficult. For such large planks, this might have been done with mallet blows at the plank ends while joining pressure was applied.
- 31 Consolidation of one damaged edge has been presented in a previous article (Brewer 1994a).
- 32 The filler, harder than plaster of Paris, had keyed well into the surrounding damaged wood. It had swelled on setting, a characteristic of plaster of Paris (Gettens and Stout 1966:253).
- 33 After a thorough facing of the area, wood inserts of similarly grained European walnut were applied to the Mengs. Only insect-damaged wood was removed, to within 2–3 mm of the ground, as with the Palmezzano. Though the wood was sized with Paraloid B72, the use of water-based glue caused considerable swelling of the higher-density walnut, which then tended to delaminate from the back of the weakened casein ground. It was then necessary to remove the remaining wood to the ground, which was strengthened with a thin size, and the inserts were directly fitted.

This approach seemed to work well, though the original wood-ground interface was lost. Epoxy fillers, which would not swell the wood so much, were considered, but penetration and flow are hard to control. Also, most cured epoxies are mechanically intractable to the movement of surrounding wood. They are also too efficient as moisture barriers, and adhesion of other glues is limited (Skeist 1977:chap. 26). Rather than the epoxy, something like a strong, flexible, two-part polyvinyl acetate or a tough acrylic, soluble in organic solvents, might be more suitable. The behavior of the wood of the Mengs was in critical contrast to that of the fibrous, lower-density wood of the Palmezzano, which swelled less from the same glue and did not transfer the swelling detrimentally. There was no apparent effect on the strongly adhered gesso ground of the Palmezzano.

- 34 It would likely have been two or more dovetail-section tapered battens, set into matching grooves in the panel back, typical for such panels (Marette 1961:pl. 14, no. 56).
- 35 Such cross-grain battens, if not fitted carefully to a panel's surface, are usually glued to the high spots only. Aside from the inherent restrictions on transverse wood movement from any glued restraint, the *intermittent* attachment also helps to localize and concentrate tensions due to restraint of differential movements of the two components. Consequently, splits are multiple and are distributed accordingly.
- 36 The greater tendency of thinned panels to move and warp in response to changes in MC is due partly to steeper moisture gradients and partly to the decrease in panel rigidity. Lucas (1963:166) referred to this, perhaps in a slight understatement, as a loss of "constructional strength." See note 6, above, for a partial explanation.
- 37 The classic horrifying scenario of knots being pulled out along with the paint by power routers is sensational but entirely possible. Vibration is another concern.
- 38 The more informed choice of balsa makes it unlikely that those who applied the balsa reinforcement also attached the edge strips.
- 39 This estimate is based on movement of 1.8% (average of 2.0% tangential and 1.6% radial) over an RH range of 30–90% at 25 °C (Building Research Establishment 1975:6).
- 40 See Gordon's absorbing discussion of "critical Griffith crack length" (Gordon 1978:chap. 5, esp. 98–105).
- 41 Because wood is viscoelastic, seasoning establishes a general stress distribution, but it does not make timber free from stress.
- 42 An example of the effect of "releasing" elastic stress is seen in the warp that may immediately develop as oak planks are sawn from thicker timber that has already been dried to EMC. (These stresses are sometimes called *tensions*.) Paintings on oak, if recently disjoined, will sometimes show variable gaps that may be partially or wholly due to the same reason.
- 43 Adequate photodocumentation of the condition and potential identifying features of the panel back is an advantage for treatment. Examination and photography with other light sources, such as infrared, may also reveal important historical or conservation-related information that future events may obscure or destroy.
- 44 Water should not be applied directly to the panel wood because it increases the risk of compression set at the back, with a subsequent tendency to greater set warp.
- 45 Other larger panels have been treated in a vertical position. One example is the *Pietà de Villeneuve-lès-Avignon* (1454–56) by Enguerrand Quarton (Louvre INV RF1569), also painted on a walnut support (Bergeon 1990:35–38).
- 46 Animal glue, for example, can form a substantial restraint.
- 47 Warp from this cause is modified by movement deriving from the cuts of the planks and by any restraint caused by applied layers and by joints.
- 48 Some effects of flattening by water application have been noted. Flattening with moisture and pressure over an extended time to induce wood plasticization and a tension set in opposition to an existing compression set has been discussed lucidly by Buck (1963 and esp. 1972). Though these elements were discussed theoretically, the practical application and consequences were not conclusive. Regarding "slippage" and flattening, Buck states that his conclusions about slip-

page at the molecular level in panels restrained flat by balsa laminates must remain theoretical “until an occasion arises to remove the balsa backing from one of the panels and to observe the actual behaviour.” (Buck 1972:11). Observations and an attempt to accomplish this process under similar conditions have not convinced the author that flattening can be achieved by higher MC and pressure alone. Gordon (1976:143) asserts that heat is the principal agent for bending wood. Other key elements, however, are time and whether the desired effect can be achieved within a *practical* treatment period. A combination of heat and moisture applied over an extended period would subject most panel paintings to considerable risks.

Chemical methods, through vapor exposure or impregnation (for example, see Wolters 1963), either interfere physically with the moisture response of the wood or alter the chemical nature of the wood. Both results alter the nature of the panel painting structure in ways that have not been tested over long periods. Again, the risks seem prohibitive. The effects and effectiveness of flattening methods should probably be investigated with controlled studies.

- 49 One method of rejoining uses wood inserts glued into V-section channels that are cut into the panel back along the split or disjoin (Uzielli and Casazza 1994:21; Bergeon 1990:22).
- 50 Recall that even the strong original joints of casein parted—rather than the surrounding walnut wood.
- 51 See, for example, the increasing frequency of articles on this subject in the journal *OPD Restauro* (1986–93).
- 52 This is a recommended average RH level for wooden objects (Thomson 1978:85).
- 53 Another possibility to facilitate the use of such long battens or similar strips for large panels is to construct the retainers from base blocks, glued to the panel, and a removable retaining plate screwed or bolted to threaded metal inserts in the blocks.
- 54 Evostik Resin W, a virtually 100% polyvinyl acetate resin, applied as a dispersion (Howells et al. 1993).
- 55 As a warp ensues, a panel that is more flexible than a reinforcing batten, for example, performs like a flexible reinforcement, so that the proper roles are reversed. Rather than the batten bending to conform to the panel’s warping movements, the panel’s warp is bent back on itself to conform to the reinforcement. Thicker panels, being more rigid (other things being equal), increase the friction against rigid reinforcements. When the friction exceeds the tensile strength of the panel, the panel will break from the stress. Bending in panels involves stresses of a more complex nature than can be discussed further here.

Materials and Suppliers

Evostik Resin W, Evode Ltd., Common Road, Stafford, England.

Paraloid B72, Conservation Resources (U.K.) Ltd., Pony Road, Horspath Industrial Estate, Cowley, Oxfordshire, England.

References

- Bergeon, S.
1990 *Science et patience, ou La restauration des peintures*. Paris: Editions de la Réunion des Musées Nationaux.
- Bodig, J., and B. A. Jayne
1982 *Mechanics of Wood and Wood Composites*. New York: Van Nostrand Reinhold.
- Bomford, D., J. Dunkerton, D. Gordon, A. Roy, and J. Kirby
1989 *Art in the Making: Italian Painting before 1400*. London: National Gallery.
- Brewer, A.
1994a A consolidation/filler system for insect-damaged wood. *Hamilton Kerr Institute Bulletin* 2:68–72.
- 1994b Aluminum devices as temporary helpers for panel structural work. *Hamilton Kerr Institute Bulletin* 2:73–76.

- 1994c An auxiliary support case history. *Hamilton Kerr Institute Bulletin* 2:61–67.
- Brown, C., A. Reeve, and M. Wyld**
- 1982 Rubens' "The Watering Place." *National Gallery Technical Bulletin* 6:26–39.
- Bruyn, J., B. Haak, S. H. Levie, P. J. J. van Thiel, and E. van de Wetering**
- 1989 *A Corpus of Rembrandt Paintings*. Vol. 3, 1635–42. Dordrecht: Martinus Nijhoff Publishers.
- Buck, R. D.**
- 1952 A note on the effect of age on the hygroscopic behaviour of wood. *Studies in Conservation* 1:39–44.
- 1962 Is cradling the answer? *Studies in Conservation* 7(3):71–74.
- 1963 Some applications of mechanics to the treatment of panel paintings. In *Recent Advances in Conservation*, ed. G. Thomson, 156–62. London: Butterworths.
- 1972 Some applications of rheology to the treatment of panel paintings. *Studies in Conservation* 17:1–11.
- Building Research Establishment**
- 1975 *The Movement of Timbers*. Technical note number 38, May 1969 (revised August 1975). London: Her Majesty's Stationery Office.
- Castelli, C., and M. Ciatti**
- 1989 I supporti lignei dei dipinti e i sistemi di traversatura: Un'analisi storica e alcune proposte operative. In *Il restauro del legno*, vol. 2, ed. G. Tampone, 141–54. Florence: Nardini.
- Desch, H. E.**
- 1956 *Timber: Its Structure and Properties*. London: Macmillan.
- Gettens, R. J., and G. L. Stout**
- 1966 *Painting Materials: A Short Encyclopaedia*. New York: Dover Publications.
- Gordon, J. E.**
- 1976 *The New Science of Strong Materials, or Why You Don't Fall through the Floor*. 2d ed. London: Pelican Books.
- 1978 *Structures*. London: Penguin Books.
- Grigioni, C.**
- 1956 *Marco Palmezzano, pittore forlivese: Nella vita, nelle opere, nell'arte*. Faenza: Fratelli Lega Editore.
- Howells, R., A. Burnstock, G. Hedley, and S. Hackney**
- 1993 Polymer dispersions artificially aged. In *Measured Opinions: Collected Papers on the Conservation of Paintings*, ed. C. Villers, 27–34. London: UKIC.
- Jobling, J.**
- 1990 *Poplars for Wood Production and Amenity*. Forestry Commission bulletin no. 92. London: Her Majesty's Stationery Office.
- Keith, L.**
- 1994 The structural conservation of Maso da San Friano's "Visitation Altarpiece." *Hamilton Kerr Institute Bulletin* 2:77–82.

- Klein, P., and J. Bauch
1990 Analyses of wood from Italian paintings, with special reference to Raphael. In *The Princeton Raphael Symposium*, ed. J. Shearman and M. B. Hall, 85–92. Princeton: Princeton University Press.
- Klein, P., and F. Bröker
1990 Investigations on swelling and shrinkage of panels with wood support. In *ICOM Committee for Conservation 9th Triennial Meeting, Dresden, German Democratic Republic, 26–31 August 1990, Preprints*, vol. 1, ed. K. Grimstead, 41–43. Los Angeles: ICOM Committee for Conservation.
- Laurie, A. P.
1967 *The Painter's Methods and Materials*. New York: Dover Publications.
- Lincoln, W. A.
1986 *World Woods in Color*. New York: Macmillan.
- Lucas, A. W.
1963 The transfer of easel paintings. In *Recent Advances in Conservation*, ed. G. Thomson, 165–68. London: Butterworths.
- Mancinelli, F.
1990 La Transfigurazione e la Pala di Monteluce: Considerazioni sulla loro tecnica esecutiva alla luce dei recenti restauri. In *The Princeton Raphael Symposium*, ed. J. Shearman and M. B. Hall, 149–50. Princeton: Princeton University Press.
- Marette, J.
1961 *Connaissance des primitifs par l'étude du bois*. Paris: Picard.
- Marijnissen, R. H.
1985 *Paintings: Genuine, Fraud, Fake: Modern Methods of Examining Paintings*. Brussels: Elsevier.
- Mecklenburg, M. E., and C. S. Tumosa
1991 Mechanical behavior of paintings subjected to changes in temperature and relative humidity. In *Art in Transit: Studies in the Transport of Paintings*, 173–216. Washington, D.C.: National Gallery of Art.
- Michalski, S.
1991 Paintings—their response to temperature, relative humidity, shock, and vibration. In *Art in Transit: Studies in the Transport of Paintings*, 223–48. Washington, D.C.: National Gallery of Art.
- Museum*
1955 The care of wood panels. *Museum* 8(3):139–94.
- Panshin, A. J., and C. de Zeeuw
1970 *Textbook of Wood Technology*. Vol. 1. New York: McGraw-Hill.
- Roettgen, S.
1993 *Anton Raphael Mengs, 1728–1779, and His British Patrons*. London: A. Zwemmer and English Heritage.
- Skaar, C.
1988 *Wood-Water Relations*. Berlin: Springer-Verlag.
- Skeist, I., ed.
1977 *Handbook of Adhesives*. 2d ed. New York: Van Nostrand Reinhold.
- Thomson, G.
1978 *The Museum Environment*. London: Butterworths.

- Tsoumis, G. T.**
1991 *Science and Technology of Wood: Structure, Properties, Utilization*. New York: Van Nostrand Reinhold.
- Uzielli, L., and O. Casazza**
1994 *Conservazione dei dipinti su tavola*. Fiesole: Nardini Editore.
- Wolters, C.**
1963 Treatment of warped wood panels by plastic deformation; moisture barriers; and elastic support. In *Recent Advances in Conservation*, ed. G. Thomson, 163–64. London: Butterworths.
- Wolters, C., and H. Kühn**
1962 Behaviour of painted wood panels under strong illumination. *Studies in Conservation* 7(1):1–9.

A Renaissance *Studiolo* from the Ducal Palace in Gubbio

Technical Aspects of the Conservation Treatment

Antoine M. Wilmering

I saw a group of students huddled before a painting. Their noses were almost, but not quite, touching the panel and the soon-to-be practicing conservators were eagerly scanning the surface. Out of curiosity I approached the group and asked them what the problem was. They started commenting on the craquelure, the pigments used, retouches, etc. It was all technically quite sound. I asked them if they would mind stepping back about four feet. Somewhat reluctantly they complied, and then I asked them what they saw. There was silence. I repeated the question. One of the students finally ventured, "A painting." "Of what?" I asked. "An angel on a hill." Exactly. The panel in question was Flemish, some school piece of Thierry Bouts perhaps. A delicate, svelte angel in a white, billowing gown holding a sword aloft stood triumphant on top of an emerald-green hillock. A magical, jeweller's landscape with winding, dusty roads, Brussels Sprout-like trees, pilgrims and horsemen threading their way through the sun-drenched countryside, and a many-turreted castle receded into an azurite infinity beyond the hillock. This meant nothing to them as far as I could tell. The students had not started their examination by considering the painting as a work of art, but as an object, a thing, with ailments. There was no sympathetic attention and they may just as well have been looking over a used car. If students are not taught first to experience works of art as objects capable of providing us with aesthetic pleasure, they will never be able to apply their technical knowledge and craftsmanship in such a way that the integrity of the work and its tradition are totally respected.

—M. K. TALLEY, "UNDER A FULL MOON WITH BB: BUILDING A 'HOUSE OF LIFE'"

THE FURNITURE CONSERVATION STAFF at the Metropolitan Museum of Art, New York, has completed the conservation treatment of the Gubbio *studiolo*, after more than a decade of work.¹ This essay provides a summary report of some technical aspects of the conservation treatment of the intarsia support panels.² The *studiolo* is a splendid example of a Renaissance study; it was built between about 1477 and 1483 for Federico da Montefeltro's ducal palace in Gubbio, Italy. Federico da Montefeltro (1422–82), duke of Urbino, was a wealthy and important patron of the sciences and the arts in the fifteenth century. He commissioned numerous works of art for his palaces, including many intarsia works and two *studioli*: one for his main ducal palace in Urbino, which still exists in situ, and the other for his palace in Gubbio (Remington 1941; Winternitz 1942; Cheles 1991; Bagatin 1992; Raggio 1992). The

painter, engineer, and architect Francesco di Giorgio Martini (1439–1502) directed the expansion of the ducal palace at Gubbio, which started in 1476 or shortly thereafter. The new Renaissance palace that emerged housed the studiolo, which also must have been designed and executed under Francesco di Giorgio's supervision. The studiolo, which was probably used as a small room for study or education, has an irregular ground plan of about 13.7 m² and consists of intarsia wall paneling that originally extended from a tiled floor to a height of 2.8 m. The intarsia panels create the illusion of an elegant interior with a trompe l'oeil bench and wall cupboards containing, among other things, books, musical instruments, Federico da Montefeltro's coat of arms, his armor, and, in the central panel, the Order of the Garter (Figs. 1, 2). A set of panel paintings attributed to Justus of Ghent (active ca. 1460–80) or Pedro Berruguete (ca. 1450–1505) depicting the liberal arts is believed to have been mounted above the intarsia panels (Davies 1955:45–53).³ A spectacular gilded and polychrome painted coffered ceiling had been mounted at 5.3 m high, supported by an equally rich decorated cornice. A Latin phrase reflecting Federico's humanist background appears in carved and gilded letters in the frieze above the intarsia panels. The Latin text,⁴ which very likely refers to the paintings, reads:

Figure 1

Studiolo of Federico da Montefeltro, duke of Urbino, from the ducal palace, Gubbio, as displayed in the Metropolitan Museum of Art, New York, in the 1950s. The floor, modeled after the fifteenth-century original (ca. 1477–83), and the window surround are modern reconstructions.



Figure 2

Detail of the central wall panel of the Gubbio studiolo during conservation treatment. The panel is constructed with various irregularly shaped matrix sections. Each door, for example, is one matrix section. The genius of the intarsiatori can be seen in the sophisticated play between light and shadow, as well as in the intricate details of the writing utensils pouch and the Order of the Garter.

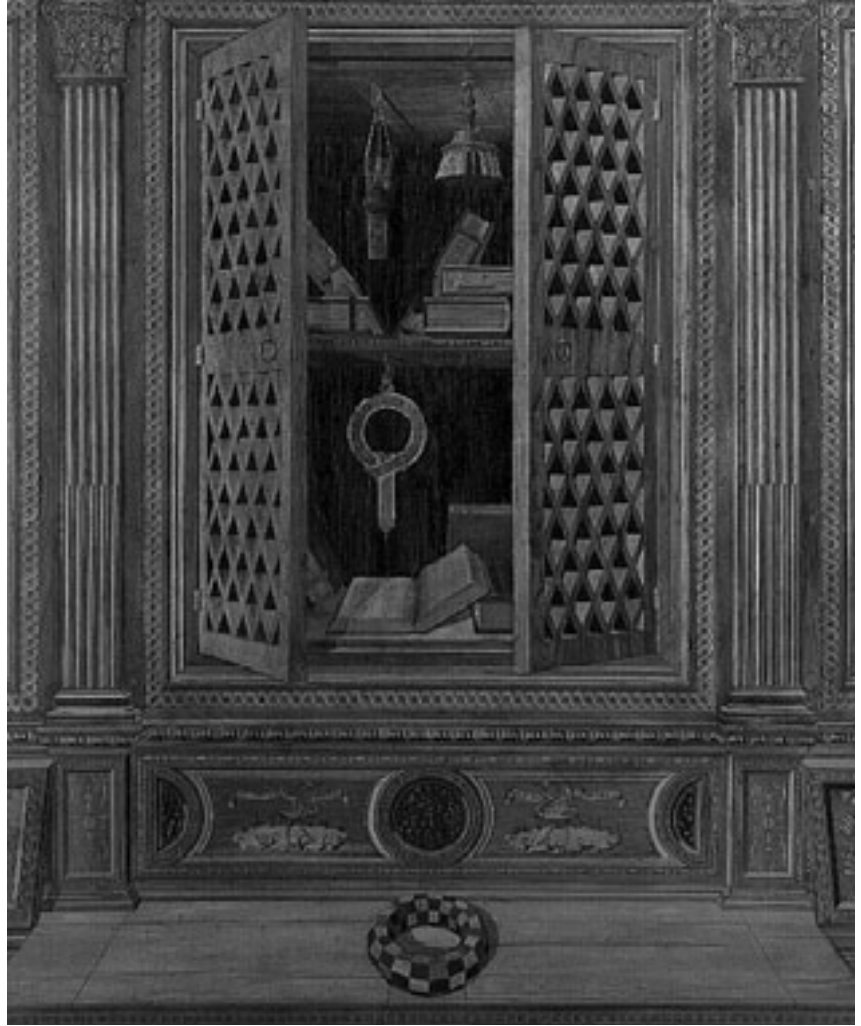

ASPICIS ETERNOS VENERANDE MATRIS ALVMNOS
DOCTRINA EXCELSOS INGENIOQVE VIROS
VT NVDA CERVICE CADANT [ORA PARENTIS
SVPPPLIC]ITER FLEXO PROCVBVERE GENV
IVSTITIA PIETAS VINCIT REVERENDA NEC VLLVM
POENITET ALTRICI SVCCVVISSE SVE.

(Menichetti 1987; Raggio 1992)

See how the eternal students of the venerable mother,
Men exalted in learning and in genius,
Fall forward, suppliantly with bared neck and flexed knee,
Before the face of their parent.
Their reverend piety prevails over justice and none
Repents for having yielded to his foster mother.⁵

Guidobaldo da Montefeltro (b. 1472), Federico's only son and second duke of Urbino, died in 1508 without an heir. From 1508 to 1631 the duchy belonged to the House of the della Rovere; when that line ended the duchy fell into the hands of the Papal States. At that time, around 1631, many of the artworks—including paintings, the books from Federico's famous library, and other portable objects—were removed from the ducal

palaces. The paintings were removed from the walls of the studiolo in 1673 and taken to Florence (Raggio 1996). It was not until the end of the nineteenth century, however, when a local family owned the ducal palace, that such major architectural fixtures as chimneypieces, door surrounds, and decorative ceilings were removed. In 1874 the studiolo was bought by Prince Filippo Massimo Lancellotti. He had the studiolo dismantled (except for the paintings, which had already been removed) and moved to his villa in the hills of Frascati, near Rome. The first major restoration of the studiolo took place before it was installed in Lancellotti's villa.⁶ A note discovered in one of the studiolo's doors confirmed the restoration and dated its completion to September 1877. In 1937 the German art dealer Adolph Loewi purchased the studiolo from the Lancellotti family. Loewi's workshop in Venice executed the second restoration (Fig. 3).⁷ In 1939 the Metropolitan Museum of Art purchased the studiolo and displayed it until 1967. The current conservation campaign started in 1987 with a rotating team of conservators, conservation fellows, and students. The project was completed in April 1996 and the room opened to the public in May 1996; the exhibition included a didactic presentation about the history and conservation treatment of the room.

The Intarsia Panels

The Gubbio studiolo was commissioned, designed, and skillfully executed during the height of the Italian intarsia tradition, which started in the middle of the fourteenth century and lasted roughly two hundred years. From the second quarter of the fifteenth century onward, the *intarsiatori* applied linear perspective (the representation of three-dimensional space on a plane surface) in their work and soon were given the honorary title *i maestri della prospettiva*, "the masters of perspective" (Ferretti 1982). The Florentines in particular had mastered the technique of creating a perfect

Figure 3

The Gubbio studiolo in the workshop of Adolph Loewi in Venice in 1938 or 1939, shortly after the restoration of the room had been completed. The configuration of the panels is not accurate. This staged setting of the studiolo was intended to show as much of the room as possible to prospective buyers.



trompe l'oeil image with naturally colored woods. The workshop of Giuliano da Maiano (1432–90), who was a woodworker, architect, and one of the most celebrated intarsiatori of the fifteenth century, probably produced the intarsias of the Gubbio studiolo (Raggio 1992). The three-dimensional illusion of the panels results from the application of the rules of linear perspective combined with a thorough understanding of the delicate play between light and shadow. The extremely skillful craftsmanship of the woodworkers is best illustrated with some intarsia details that reveal the precision and subtleties of the inlay (Fig. 2).

Intarsia Technique in the Fifteenth Century

A basic form of intarsia is called *intarsia a toppo*: repetitive, geometric decorations created by inlaying complicated, often symmetrical patterns into a walnut substrate or matrix. The designs were often simple. The woodworkers laid them out with measuring tools such as rulers, squares, and compasses. The more elaborate intarsia images required design drawings and cartoons. Generally the painters, who often collaborated with woodworkers on other projects as well, supplied the designs and cartoons for figurative intarsias. Alessio Baldovinetti (1425–99), for example, supplied a cartoon for the Nativity panel, which Giuliano da Maiano executed for the new sacristy of the Duomo of Florence (Haines 1983).

The steps of creating an intarsia panel are not known to have been recorded; however, examination of the various intarsias suggests that some were made as follows: The intarsiatori first cut the wood sections to be inlaid according to a design or cartoon. They used saws, planes, adzes, chisels, and knives to form these approximately 5 mm thick sections, or tesserae, into the desired shapes. The next step was to outline, cut, and excavate the matrix wood (usually walnut), so that the various tesserae could be inlaid into the excavated areas. The intarsiatori typically used a shoulder knife, first, to set the outline of the areas to receive the inlay and, second, to remove the wood with gouges down to the depth of the first knife cuts. They next made a new series of knife cuts along the same outline and removed more wood down to a depth of about 5 mm. Once the matrix wood was ready for inlay, the intarsiatori secured the tesserae into the matrix with hot protein glue or cold casein glue. After this initial round of inlay, they planed the surface until it was level. By then, a basic design could be recognized. The use of the shoulder knife caused the walls of the excavated wood to taper slightly, creating a very tight-fitting inlay—much tighter than that achieved with later marquetry techniques. The matrix often formed part of the image and therefore, in many instances, remained partly visible after the work was completed.

The intarsiatori further inlaid the panel to create finer detail, adding rounds of inlay until satisfied with the final image. They cut slightly less deeply after each round of inlay, and each time they planed the surface of the wood. No known cartoons for intarsias have survived, a fact that suggests that the cartoons were cut and used during the intarsia-making process.⁸

The intarsia panels from the Gubbio studiolo were made using these techniques. Locally available woods such as walnut (*Juglans* spp.) in various shades, pear (*Pyrus* spp.), mulberry (*Morus* spp.), bog oak and brown oak (*Quercus* spp.), spindle tree (*Euonymus* spp.), cherry (*Prunus* spp.), and others were part of the “palette” of the woodworkers. These woods provided a variety of colors and shades, as well as the different

grain and texture so essential in creating the extraordinarily intricate intarsia images. One colored wood stands out as unique among the more common wood colors. It is a green wood, stained by the fungus *Chlorociboria* (Blanchette, Wilmering, and Baumeister 1992). The wood is stained in the forest, when dead trees or branches become infected by this particular fungus. The intarsiatori were quite familiar with this phenomenon, and the use of green wood can be seen, for example, in some of the inlaid book covers and in the feathers of the small parrot in the Gubbio studiolo.

In the Gubbio studiolo the intarsiatori assembled the various matrix sections to form a full- or half-height wall panel. They then nailed the matrix, sections from the front, to a backing of poplar support panels, with handwrought nails (Fig. 4). The nails pierced the back of the support, and their tips were bent over and driven back into the wood. The intarsiatori then concealed the nail heads with a piece of inlay. In many instances they predrilled the location for the nails to prevent the wood from splitting.

Approach to Conservation

The conservation treatment of the Gubbio studiolo has proceeded along two paths. One proved to be a fairly straight lane, while the other is best described as a rugged trail with narrow passes, fallen trees, and rewarding scenic views. The straight lane involved preserving the structural integrity of the room, including such work as stabilizing the wall panels and ceiling construction and consolidating loose inlay and flaking paint. The rugged trail was more challenging to tread; it involved the aesthetic decisions necessary to preserve the visual integrity of the extraordinary fifteenth-century Renaissance room. These aesthetic decisions could be made only in relation to a virtual mental reference collection of similar intarsia works, as well as paintings, illuminated manuscripts, drawings and prints,

Figure 4

Exploded drawing illustrating how the various matrix sections form half a panel (in this case panel 7 top). Each matrix section is nailed to the support panel, and the nails are typically hidden beneath the intarsia. Each support panel originally had one or two vertical battens for strength. Only one original batten remains, at the bottom of panel 6, the model for shaping those in the drawing.

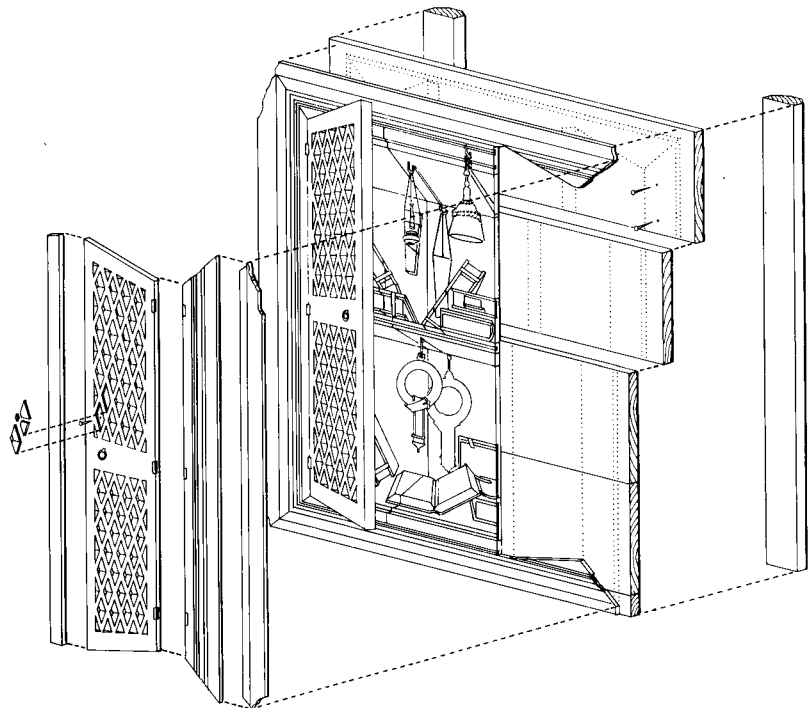

architecture, furniture, and other decorative arts. All of these were products of a unique moment in European history, rich in humanist interests, scientific pursuit, and artistic expression. During this vibrant time of curiosity and imagination, a historic consciousness emerged that was not only new to a whole generation of nobility but also new to middle-class merchants and artisans. Human and architectural proportions and nature were studied in depth, as were such abstract subjects as volume, color, light, and perspective.

Therefore, we cannot simply talk about the preservation of a room with intarsia wall panels and a polychrome ceiling that happens to have been built at the end of the fifteenth century. The studiolo, constructed at the height of the Italian Renaissance, was designed with great deliberation, every component serving a purpose, and even the seemingly casual placement of the tesserae was carefully considered. The studiolo strongly reflects the zeitgeist of the Renaissance. During the current conservation treatment, the goal of maintaining the integrity of the intarsia wall panels and polychrome ceiling has been at least as important as the physical preservation of the material. The aesthetic pleasure that Federico and his son Guidobaldo da Montefeltro must have felt upon entering the studiolo is what we should be able to feel today. As Talley says, no object should be considered solely as “a thing, with ailments.” His description at the beginning of this article of the generic Flemish landscape painting as a “magical, jeweller’s landscape” captures the essence of every work of art (Talley 1992).⁹

With these aesthetic considerations foremost, the conservation treatment of the Gubbio studiolo has proceeded; requirements have ranged from cleaning, consolidating, and retouching the intarsia and polychrome paint to fabricating complicated replacements for both the intarsia panels and the polychrome ceiling components. The focus of this article is the treatment of the supports of the intarsia panels and the coffered ceiling.¹⁰

The main concept of the conservation treatment can be summarized as follows: to preserve and restore the fifteenth-century character of the studiolo. All the original elements of the room were to be conserved¹¹ and the nineteenth- and twentieth-century restorations kept, where possible. These later restorations were respected as part of the history of the studiolo; even so, they were replaced in areas where the initial fifteenth-century intention of the intarsia panel had been misinterpreted, and the restorations had consequently disfigured the image. The intarsiatori executed original intarsia panels with a sophisticated sense of the delicate play between light and shadow and with a superb eye for detail. Today the aged wood still displays more contrast and a warmer tone scale than many of the later restorations, which have discolored—competing with, rather than complementing, the fifteenth-century elements.¹² Much of the treatment, therefore, consisted of integrating past restorations to bring out a coherence that had been compromised, within the intarsia panels and between the intarsia panels and the polychrome elements. New additions were kept to a minimum, and where possible they were made reversible. Unfortunately, the polychrome paint of the ceiling elements had sustained considerable damage over time, and the later restorations had badly discolored and flaked. These previous restorations were, therefore, completely removed. This removal prompted extensive repainting, which was possible because of the repetitive decorative pattern of the ornamentation.

Condition of the Intarsia Panels

The intarsia panels, and indeed the entire room, had sustained damage from the studiolo's four-hundred-year tenure at the Gubbio palace, especially in those years when the palace was neglected and abandoned. The ducal palace housed a candle factory near the end of the nineteenth century. Paul Laspeyres, who saw the studiolo in its original location in 1873, described it nine years later as being in a "severely deteriorated state."¹³ The Lancellotti and Loewi restorations had aged, and many of their interventions had become visible. Woodworm infestation had substantially deteriorated the supports, and they had lost structural strength.¹⁴ In areas, the back panels and matrix sections had separated, and in a number of locations, the inlay was loose and protruding from the matrix sections. Also, many of the restorations were discolored. In some instances wood replacements had been selected without respect for either grain direction or the proper species. Thin rosewood (*Dalbergia* spp.)¹⁵ veneer, for example, was used to restore areas that should have been restored with brown oak or bog oak.

Treatment of the Intarsia Panels

The intarsia images were cleaned with a variety of gentle cleaning emulsions containing hydrocarbon solvent, water, and soap.¹⁶ A thin layer of 7.5% shellac was applied to the surface to saturate the wood colors and serve as a retouching varnish.¹⁷ Intarsia elements that had become detached were reglued with traditional warm protein glue (hide glue). Discolored restorations were toned with either watercolor or dilute Golden acrylic color to create a balance with the aged fifteenth-century intarsia. Missing elements were replaced with wood, which was carefully selected with a concern for the proper species and for similarity in texture, grain direction, hue, and density.

A few of the intarsia images had no back supports and needed elaborate intervention to restore their structural strength. The state of each detached intarsia varied from panel to panel. Some panels had no remaining hardware at all, while in others the original nails had been clipped, and stubs ranging from 0.5 to 1.0 cm in length protruded from the back of the matrix sections. The intarsia panels that still possessed their original supports had survived well over the last five hundred years because of the flexibility inherent in the original nailing system. Therefore, it was of particular importance to restore the original nailing system in each of the damaged panels. A number of solutions were devised to ensure that the original "pull," or force of the nails, in each panel was approximated as closely as possible. Most boards had little, if any, planar distortion, or warping. Existing splits and gaps were not filled or otherwise treated, since the panels were in equilibrium with the matrix sections, and it was important to avoid introducing any new forces.

The most effective solution to restoring the original nailing system in the damaged panels was also the simplest, as those nails where a stub of about 1 cm had been left could be cut with a positive thread. Solid brass extensions were then fabricated;¹⁸ they were hollow on one end, which was tapped with a negative thread to fit the threaded nail stub. The other end of the brass extension was cut with a thread that could be used to fasten it with a washer and nut to the back of the new support (Figs. 5–8).

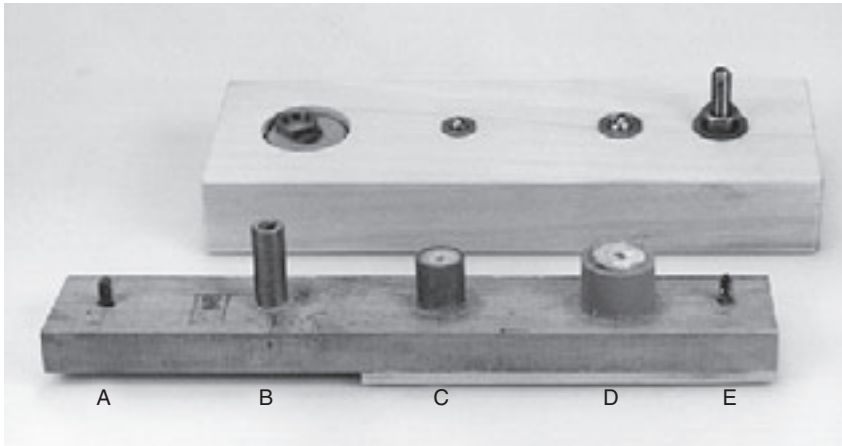

Figure 5, above

Test and demonstration model of a variety of attachment systems considered for the intarsia matrix sections and the new poplar support. From left to right: (a) an imitation of a clipped nail; (b) a short notched nail extended with a threaded tube glued with epoxy resin onto the stub; (c) and (d) small round pieces of wood glued with hide glue to the matrix, with their grain in the same direction as the matrix sections, protected from splitting by small collars; and (e) a nail stub cut with a thread and fitted with a brass extension.

Figure 6, above right

Detail of Figure 5 showing the two most frequently used attachment systems (d and e).

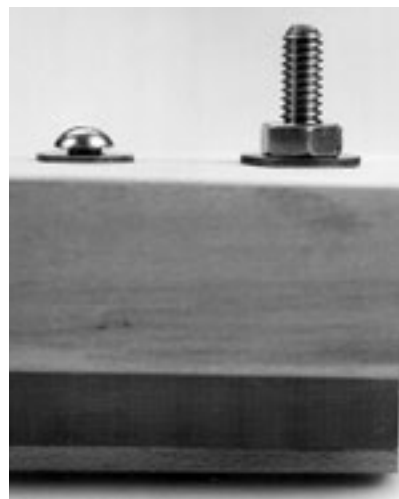

Figure 7

Detail of Figure 5. A poplar board is attached with the systems shown in Figure 6.

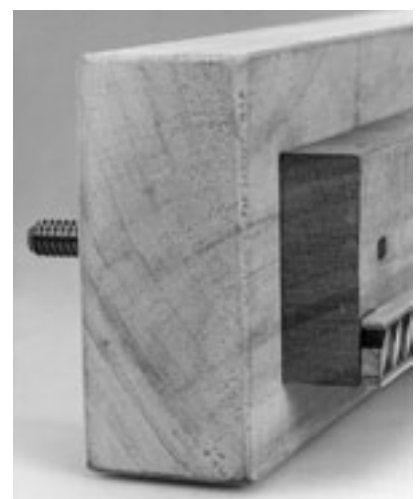

Figure 8

Side view of the attachment of the poplar board shown in Figure 7 (attachment system e). From left to right: the end of a threaded brass extension, the poplar support, the walnut matrix with a remaining nail stub, and a strip of inlay.

Some nail stubs were too small (shorter than 0.5 cm) to be threaded and therefore needed a different extension system. A hollow piece of threaded brass, similar that used by electricians, was secured to the nail stub with carvable epoxy resin (Araldite AV 1253/HV 1253). Before the resin was applied, the wood surrounding the nail stub was isolated with a thin layer of protein glue. The nail stubs were notched and degreased for better adhesion with the epoxy resin. After being secured to the matrix sections, the brass extensions were fastened to the supports by washers and nuts (Fig. 5).

A third method was necessary in areas where the nails had been removed completely. Small round cylinders of wood, measuring about 1.6 cm in diameter and 1.4 cm high, were glued to the matrix sections next to where the nails had been removed. This was done to approximate as closely as possible the original forces in the intarsia panel. The grain of

Figure 9

Reverse of panel 8 top. The separate matrix sections are clearly visible. Remaining nail stubs have been threaded, and wooden cylinders, with their collars, have been put into place.



Figure 10

Reverse of panel 8 top. The new boards have been attached with a combination of attachment systems (d and e—see Fig. 5).

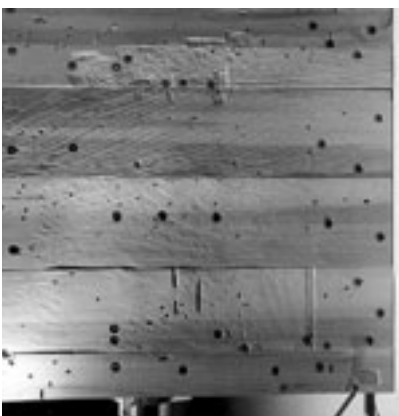
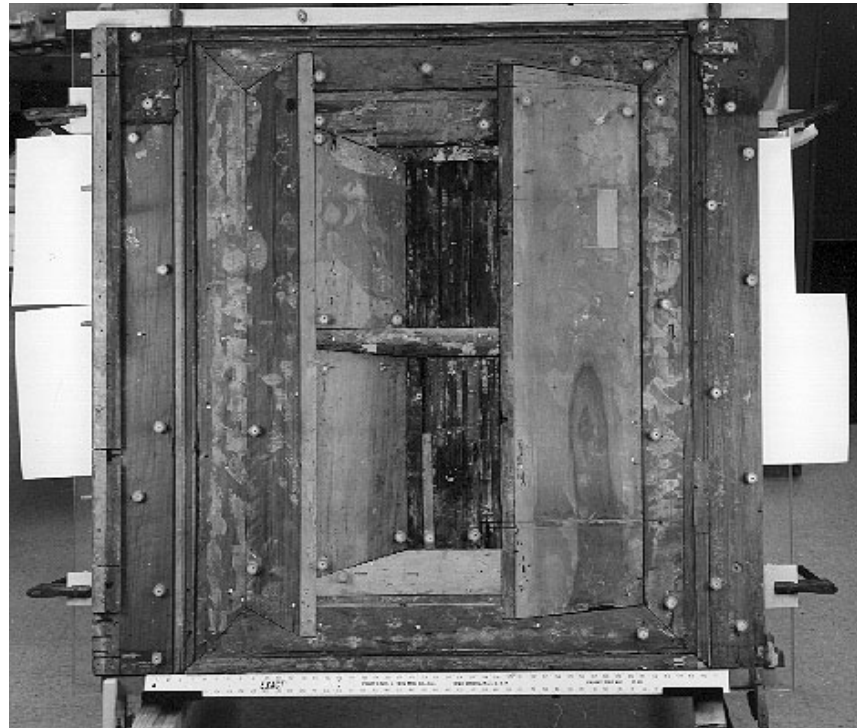

Figure 11

Proper front side of the new support of panel 8 top. This side of the support has been shaped to accommodate irregularities in the matrix sections, thus ensuring that the front of the panel (matrix and inlay) produces a level surface.



the wood cylinders was placed in the same direction to match each matrix section. The cylinders were glued to the matrix section with hot protein glue.¹⁹ A plastic collar was glued around the cones with Araldite to prevent the wood from splitting, because the supports were attached to the cylinders by screws (Figs. 5, 6, and 9).

Cottonwood (*Populus* spp.) was selected for the new support panels, to match as closely as possible the original Italian black poplar and its properties. The wood was purchased air-dried in Louisiana and stored in the conservation studio for two years prior to its use. The new boards, which were mostly sawed in semiquarter direction, were abutted to approximate as closely as possible the width of the original boards. The fronts of all new boards were meticulously shaped to match any irregularities of the matrix section backs. This ensured that the matrix sections had level surfaces once the new supports had been installed (Figs. 10, 11).

One board in panel 9–10 top had to be removed from the support because it was too deteriorated to provide adequate structural strength for the intarsia panel (Figs. 12, 13). X radiographs confirmed extensive wood-worm tunnels that former restorers had filled with stucco, a plasterlike material (Fig. 14). The board was removed, as much as possible in one piece, so it could be kept and stored separately from the studiolo. The remaining nails²⁰ attaching the matrix to the support were straightened, and the entire board was lifted from the matrix sections. Two pieces of cottonwood, cut to the size of the old board, were glued together to make a new board. The old nails were reused—but not in the traditional manner, which might have broken them. They were cut with a thread so that they could be fastened with a washer and nut through the new board. Where necessary, additional round sections of wood were glued to the matrix sections, in close proximity to the old nails, to ensure that there were ample areas of attachment. The new board provided enough strength

Figure 12

Panel 9–10 top. The panel has been photographed on one of the specially designed project worktables. The working surface of the tables can be tilted vertical (as shown) to allow proper viewing of the work in progress.

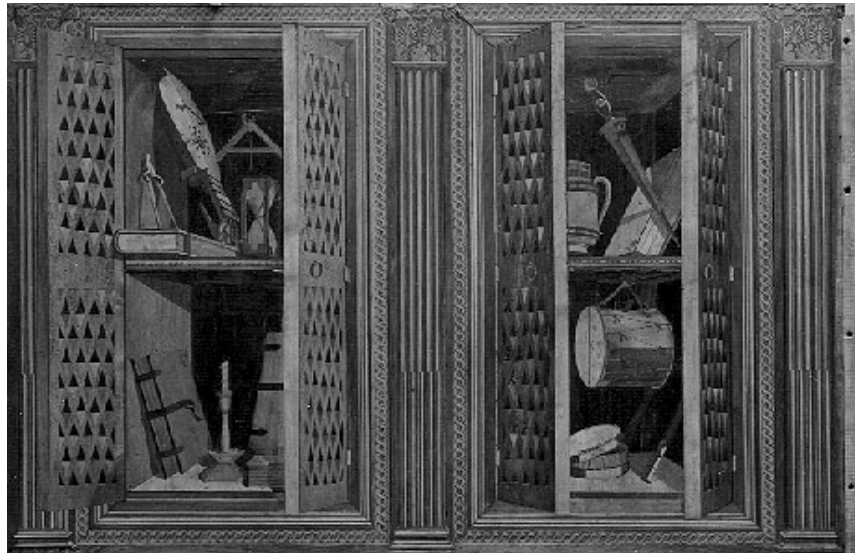

Figure 13

Reverse of panel 9–10 top. The second board from the bottom was too deteriorated to provide adequate support.

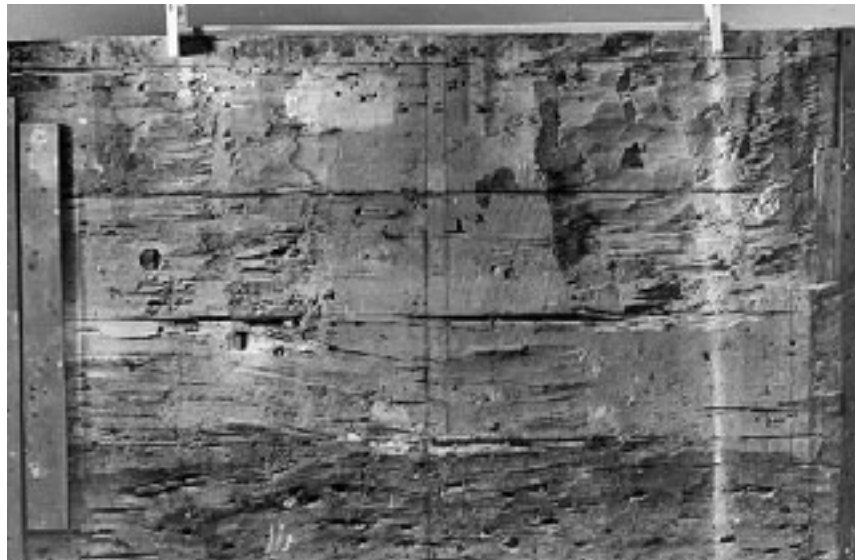

Figure 14a, b

Reverse of panel 9–10 top. The deteriorated board has been removed, and the remaining nails piercing the matrix sections have been straightened (a). The X radiograph (b) reveals the extensive stucco fills, which, combined with the deterioration, were the main reason for the removal of the board.



a



b

Figure 15

Reverse of panel 9–10 top. The new board is in place, and new battens have been attached. The substantial damage to the lower board was not treated; the gap in the center was filled, however, with sections of balsa placed without adhesive.



to the intarsia panel so that none of the adjacent boards, which had fragmentary deterioration at the sides, required removal (Fig. 15).

Ceiling and Polychrome Elements

The polychrome coffered ceiling, in keeping with fifteenth-century practice and similar to the ceiling in the Urbino studiolo, had been constructed from poplar (*Populus* spp.) with very little wood joinery but with an abundance of handwrought nails (Figs. 16, 17) (Luchinat 1992:23–27; Rotondi 1973).

The nailing system of the ceiling contributed to the fairly well preserved structure of the ceiling components. Areas of extensive former woodworm infestation, however, needed conservation treatment. The ceiling had been restored and expanded with fir, although the original wood was poplar. The nineteenth- and twentieth-century polychrome restorations were badly discolored and flaking, while the fragmentary remaining fifteenth-century paint was fairly well preserved under a layer of grime.

Treatment of the Ceiling and Polychrome Elements

The infested areas of the ceiling components needed to be treated in order to preserve the ceiling and to ensure safe display at a height of 5.3 m. Consolidation with synthetic resin was considered but not executed because this plan would have substantially increased the weight of the ceiling. Instead, a mechanical system was devised to support the infested areas from above the polychrome hexagons. Steel plates of the proper shape were welded to a 20 cm piece of threaded steel.²¹ These plates were mounted above the hexagons, with their thread through the backing. The nineteenth-century beams bore the weight by means of smaller aluminum crossbars.

Figure 16

View of the small ceiling from the window niche during the conservation treatment. This portion of the ceiling was almost entirely repainted in the nineteenth century. The decorative borders, with their fifteenth-century gilding and azurite paint, are mostly original.

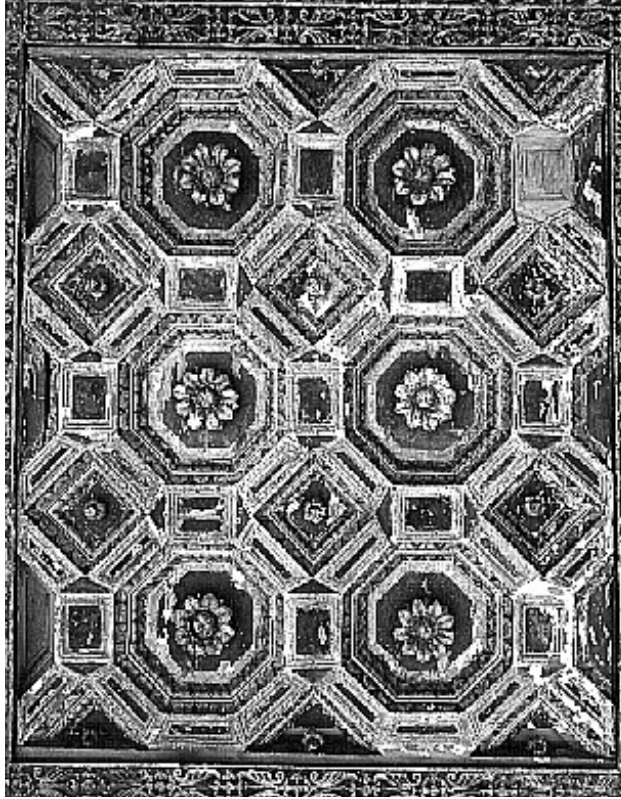
*Figure 17*

X radiograph of the ceiling of the window niche, showing the absence of joinery and the abundant use of nails. The fifteenth-century paint has survived only fragmentarily, as can be seen, for example, in the octagons, which have dark "islands" of slightly denser original paint.

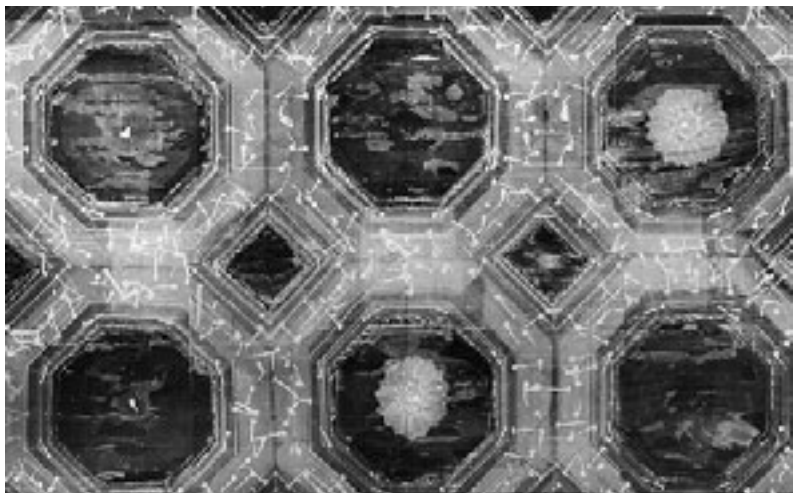

The original fifteenth-century paint was consolidated with fish glue and the surface lightly cleaned with saliva. Most of the nineteenth- and twentieth-century restorations were removed with either a methylcellulose gel or an acetone gel, according to which binding media was used in the later restorations. A new ground of gesso was applied after the wood had been prepared with glue size. The decorative elements were repainted with gouache and dry pigments in Arkon P90 resin²² as a binder. New gilding was applied in the traditional manner. All new inpainting was executed to match the aged, original fifteenth-century paint.

Through the conservation treatments discussed above, this Italian Renaissance masterpiece has regained some of its former glory (Figs. 18, 19).

Figure 18
Main ceiling of the studiolo after conserva-
tion treatment.

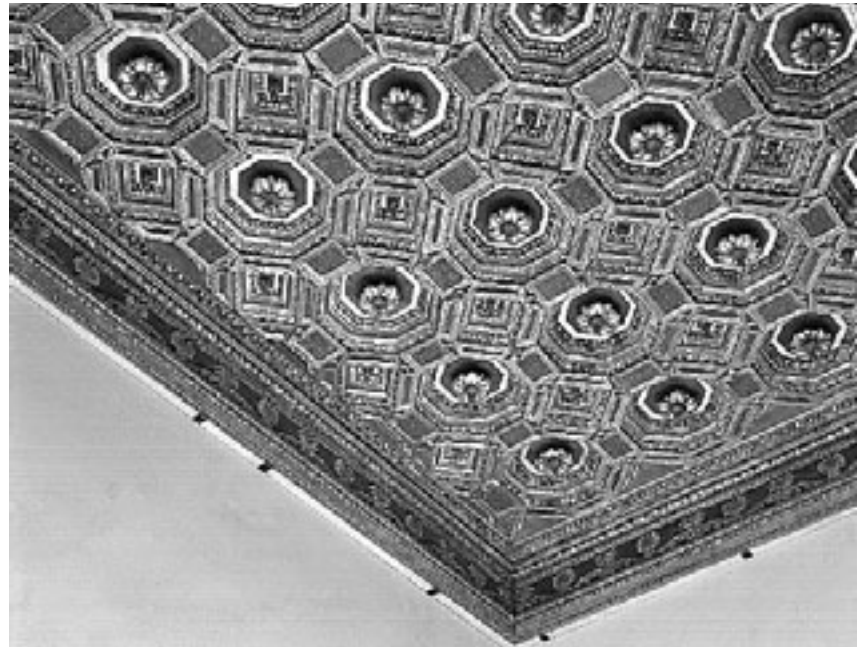

Figure 19
The Gubbio studiolo after conserva-
tion treatment.



Acknowledgments

The author dedicates this article to Charles D. Wright and John Kitchin, retired chief conservation officers of Furniture and Woodwork at the Victoria and Albert Museum, London, and to Bertus F. Boekhoff, retired senior furniture conservator at the Historical Museum of Amsterdam, for so kindly and generously handing him the tools of his profession.

The conservation treatment of the Gubbio studiolo could not have been achieved without the support, advice, and interest of a number of key players. The author would like to express his gratitude to Olga Raggio, Iris and B. Gerald Cantor Chair of the Department of European Sculpture and Decorative Arts, for her guidance and continuous support of the conservation treatment of the Gubbio studiolo. He is grateful to Tony Frantz, conservator in charge of the Sherman Fairchild Center for Objects Conservation, for his trust and encouragement during the many years of conservation work. He also owes a great debt to George Bisacca, conservator at the Sherman Fairchild Center for Paintings Conservation, who generously shared his vast knowledge of Italian intarsia, woodwork, and technology. Over the years a number of conservators, conservation fellows, and students have been part of the Gubbio conservation team. The author would especially like to thank and acknowledge Susan Klim, formerly associate conservator, and Mechthild Baumeister, associate conservator, as well as John Canonico, Rudy Colban, Mark Minor, Fred Sager, Pavol Andrasko, Albert Neher, Dennis Degnan, Ralph Stoian, Birgitte Uhlrau, Carmen Chizzola, John Childs, Jack Flotte, Susan Müller-Arnecke, Constanze Doerr, Ann MacKay, Anke Tippmann, Henriëtte Bon-Gloor, Carole Hallé, Perry Choe, Hong Bae Kim, Amy Kalina, Stephanie Massaux, and Jacqueline Blumenthal for their valuable contributions to the project and for their excellent and skilled conservation work on the Gubbio studiolo. He also sincerely thanks Bruce Schwarz and Bob Goldman of the Metropolitan Museum's photo studio for their superb photography and print work.

Notes

- 1 At the time this paper was presented in spring 1995, the conservation treatment was in progress; it has since been completed. The room opened for exhibition in May 1996.
- 2 A *Metropolitan Museum of Art Bulletin* on the Gubbio studiolo authored by Olga Raggio and Antoine M. Wilmering was published in spring 1996 to celebrate the studiolo's reinstallation. Olga Raggio is the Iris and B. Gerald Cantor Chair of the Department of European Sculpture and Decorative Arts. A major book on the subject is being prepared by the same authors; it is scheduled for publication by the Metropolitan Museum of Art in 1998.
- 3 Two paintings of the set, *Music* and *Rhetoric*, have been preserved at the National Gallery in London. Two more paintings, *Astronomy* and *Dialectic*, were preserved up to World War II at the Kaiser Friedrich Museum in Berlin. The liberal arts were commonly, although not exclusively, grouped as seven in the *trivium* and *quadrivium*. It is unknown whether any more paintings of the group exist.
- 4 The Latin text had suffered losses over time and was restored on several occasions. In the various descriptions by Dennistoun (1909), Laspeyres (1882), and Gabrielli (late sixteenth century), published in Menichetti (1987), different losses and discrepancies are apparent.
- 5 The author is grateful to John Marincola, associate professor at Union College, Schenectady, New York, for his suggestion for a missing section in the Latin inscription, as well as for his suggestions for the translation of the text, which is partially based on the *Codice Gabrielli* cited by Menichetti (1987), Nachod (1943), and Laspeyres (1882). The translation is taken from Raggio (1996).

- 6 Paul Laspeyres, a German architectural scholar who visited the ducal palace in 1873, mentions that Prince Lancellotti purchased the studiolo for L 7,000 and that it had been thoroughly restored (Laspeyres 1882).
- 7 The author is grateful to Mrs. William J. Robertson, who shared much information on the restoration of 1937. She was eighteen years old at the time the studiolo was at her father's workshop, and she recalls having been involved in the restoration of the incomplete Latin text. The workshop operated separately from Adolph Loewi, but according to Mrs. Robertson, it executed all restorations for the firm.
- 8 Intarsia making typically involves a design drawing from which cartoons on paper are produced (Haines 1983). These cartoons are suitable for transferring the design onto the wood. In this process the cartoons are cut into smaller pieces and glued to the wood surface. This technique allows the intarsiatori to cut accurately along the outline with woodworking tools to produce properly shaped tesserae. The technique, in which the cartoons are destroyed, is practiced today by marquetry cutters (Ramond 1989).
- 9 The author owes a great debt to M. Kirby Talley Jr. for kindly allowing him to reproduce the passage quoted at the beginning of this article (Talley 1992).
- 10 See note 4 above.
- 11 Some elements—for example, one of the boards of the support panel opposite the studiolo's entrance—had to be replaced because they no longer provided adequate structural strength.
- 12 The natural wood colors would have been richer, and the designs of the intarsia panels would have had more contrast in the fifteenth century. Wood owes much of its color to the gums and deposits it contains. Light-colored woods generally have fewer of these materials than darker colored woods. During aging, two factors play a role in the change of a wood's color. First, the gums and deposits tend to fade, much as do natural textile dyes. Second, the main components of wood, cellulose and hemicellulose, bleach upon aging, while lignin darkens. Thus, the aging process causes the wood colors to draw together in tone and display a less vivid chroma.
- 13 "Noch sah ich dasselbe, wenn auch im Zustande arger Verwahrlosung im Jahre 1873" (Laspeyres 1882:77).
- 14 No signs of active woodworm infestation marked any of the panels or ceiling components. It is very likely that the panels and ceiling were fumigated around 1937–39.
- 15 South American rosewood would not have been available in Italy in the third quarter of the fifteenth century. Small quantities of tropical woods may have been available through the trade routes in Africa and Asia. It is unlikely, however, that these precious woods would have been used in secondary areas in the intarsias (Baxandall 1986; Meilink-Roelofs 1962; Origo 1985).
- 16 The mildest cleaning emulsion consisted of 600 ml Shellsol 71, 100 ml water, and 0.75% Brij 35, a nonionic soap. The author is grateful to Richard Wolbers, associate professor in the Art Conservation Department at the University of Delaware, for his advice in making this emulsion. Where necessary, a slightly stronger cleaning agent (composed of 445 ml benzene, 40 ml oleic acid, 15 ml triethanolamine, and 500 ml water) was used.
- 17 A 7.5% shellac solution was preferred to a B72 solution, because the shellac provided fuller color saturation for proper evaluation of the intarsia images. It formed a base for inpainting some of the nineteenth- and twentieth-century restorations. It also protectively coated the wood surface during consolidation in case of glue spillover.
- 18 The brass extensions were fabricated by Gerard Den Uijl, supervising maintainer of the machine shop at the Metropolitan Museum of Art.
- 19 A high-quality protein glue with a strength of about 640 g was used. It is a very pure glue, possessing a high shear factor and no additives, made to the specifications of William Monical, violin maker and restorer. The author is grateful to Stewart Pollens, associate conservator of the Department of Musical Instruments at the Metropolitan Museum of Art, for advice about this glue and its properties.
- 20 Many nails had already been removed, probably by the Loewi restoration of 1938.
- 21 The stainless steel plates were made by Gerard Den Uijl, supervising maintainer of the machine shop at the Metropolitan Museum of Art.

- 22 Arkon P90 is a synthetic resin that dissolves in Shellsol 71. It is a very stable resin and has little tendency to cross-link, or discolor, when mixed with a small quantity of Tinuvin 292, a UV inhibitor (Rie and McGlinchey 1990).

Materials and Suppliers

Araldite AV 1253/HV 1253, Industrial Sales Association Inc., 39 Henry J. Drive, Tewksbury, MA 01876.

Arkon P90 resin, Conservation Support Systems, P.O. Box 91746, Santa Barbara, CA 93190.

Brij 35, Sigma, P.O. Box 14508, St. Louis, MO 63178.

Golden acrylic, Golden Artist Colors Inc., 188 Bell Road, New Berlin, NY 13411.

Shellsol 71, Shell Solvents, 200 Pickett District Road, New Milford, CT 06776.

Tinuvin 292, Conservation Support Systems.

References

- 1992 **Bagatin, P. L.**
Studiolo. In *Piero e Urbino, Piero e le corti rinascimentali*, ed. P. Dal Poggetto, 356–60. Venice: Marsilio.
- 1986 **Baxandall, M.**
Schilderkunst en leefwereld in het quattrocento. Nijmegen: SUN.
- 1992 **Blanchette, R. A., A. M. Wilmering, and M. Baumeister**
The use of green-stained wood caused by the fungus *Chlorociboria* in intarsia masterpieces from the 15th century. *Holzforschung* 46(3):225–32.
- 1991 **Cheles, L.**
Lo studiolo di Urbino: Iconografia di un microcosmo principesco. Ferrara: Franco Cosimo Panini.
- 1955 **Davies, M.**
Early Netherlandish School. London: National Gallery.
- 1909 **Dennistoun, J.**
Memoirs of the Dukes of Urbino. Annotated by E. Hutton. 3 vols. New York: John Lane.
- 1982 **Ferretti, M.**
I maestri della prospettiva. In *Storia dell'arte italiana*, vol. 2, ed. F. Zeri, 457–585. Torino: Einaudi.
- 1983 **Haines, M.**
The "Sacrestia delle Messe" of the Florentine Cathedral. Florence: Cassa di Risparmio di Firenze.
- 1882 **Laspeyres, P.**
Die Baudenkmale Umbriens. 9. Gubbio. In *Zeitschrift für Baukunst*, vol. 31, 62–82. Berlin: Ministerium der öffentlichen Arbeiten.
- 1992 **Luchinat, C. A., ed.**
I restauri nel Palazzo Medici Riccardi. Milan: Silvana.
- 1962 **Meilink-Roelofs, M. A. P.**
Asian Trade and European Influence. The Hague: Martinus Nijhof.
- 1987 **Menichetti, P. L.**
Storia di Gubbio. Vol. 1. Città di Castello, Italy: Petrucci.

- Nachod, H.
1943 The inscription in Federigo da Montefeltro's studiolo in the Metropolitan Museum. *Medievalia et Humanistica* 2:98–105.
- Origo, I.
1985 *De Koopman van Prato*. Amsterdam: Contact.
- Raggio, O.
1992 Lo studiolo del Palazzo Ducale di Gubbio. In *Piero e Urbino, Piero e le corti rinascimentali*, ed. P. Dal Poggetto, 361–65. Venice: Marsilio.
- 1996 The liberal arts studiolo from the ducal palace at Gubbio. *Metropolitan Museum of Art Bulletin* 53(4):5–35.
- Ramond, P.
1989 *Marquetry*. Newton: Taunton Press.
- Remington, P.
1941 The private study of Federigo da Montefeltro. *Metropolitan Museum of Art Bulletin* 36(1):3–13.
- Rie, E. de la, and C. W. McGlinchey
1990 New synthetic resins for picture varnishes. In *Cleaning, Retouching, and Coatings*, ed. John S. Mills and Perry Smith, 168–73. London: International Institute for the Conservation of Historic and Artistic Works.
- Rotondi, P.
1973 Ancora sullo studiolo di Federico da Montefeltro nel Palazzo Ducale di Urbino. In *Restauri nelle Marche: Testimonianze acquisti e recuperi, Urbino, Palazzo Ducale, 29 giugno–30 settembre, 1973*, 561–604. Urbino: Soprintendenza alle Gallerie e Opere d'Arte delle Marche.
- Talley, M. K.
1992 Under a full moon with BB: Building a "house of life." In *Museum Management and Curatorship* 11:347–73. Oxford: Butterworth-Heinemann.
- Wilmering, A.
1996 The conservation treatment of the Gubbio studiolo. *Metropolitan Museum of Art Bulletin* 53(4):36–56.
- Winternitz, E.
1942 Quattrocento science in the Gubbio study. *Metropolitan Museum of Art Bulletin* 1(2):104–16.

Microclimate Boxes for Panel Paintings

Jørgen Wadum

Probably there is no construction that suffers more seriously as a result of the movement of wood than the paint on a painted panel.

—R. D. BUCK, 1952

IN A POORLY CLIMATIZED MUSEUM or during transit, it is crucial to control continuously the moisture content of humidity-sensitive objects such as wood, fabric, and paper.

The use of microclimate boxes to protect vulnerable panel paintings is, therefore, not a new phenomenon of the past two or three decades. Rather, it has been a concern for conservators and curators to protect these objects of art at home and in transit since the end of the nineteenth century. The increased number of traveling exhibitions in recent years has heightened the need to protect paintings during circulation (Thomson 1961; Mecklenburg 1991).

Departures from the usual climatological surroundings may cause swelling or shrinkage of a panel, resulting in cracks, splits, and cleavage of the support or between the support and image layers (Stolow 1967). Early research in packing has covered some aspects that are used as criteria for the microclimate boxes (Stolow 1965, 1966, 1967).¹ Although there may not be an “ideal” relative humidity (RH) for museums, it is evident that some objects require, or would benefit from, separate microenvironments, regardless of the chosen RH set point (Erhard and Mecklenburg 1994).

The use and design of microclimate boxes have been evolving since 1892. These boxes may be divided into three broad groups: those using an active buffer material to stabilize the internal RH, a more recent box containing no added buffer material, and, in recent times, boxes with an altered gas content. Another concern is the appearance (aesthetics) of the box.

Wood as a Hygroscopic Material

The cross-grain instability of wood has been a perennial problem to artisans as it is in the nature of wood and wooden objects to seek an equilibrium between internal moisture content and that of the surrounding atmosphere (Fig. 1a, b) (Buck 1961).²

Examination of the hygroscopic behavior of various wood species shows that green as well as old wood responds to changes in humidity (Buck 1952, 1962).³ The swelling and shrinkage of two panels was

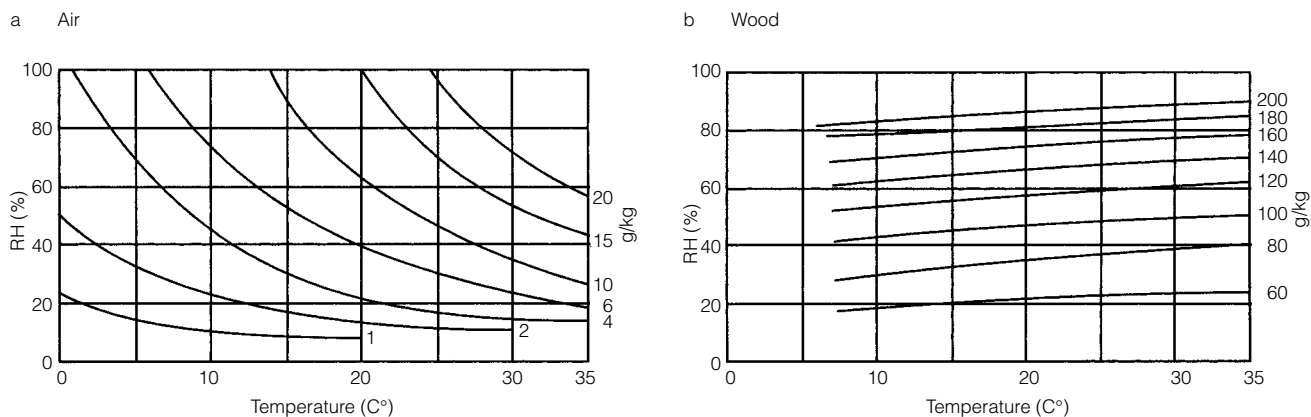

Figure 1a, b
Correlation between RH, temperature ($^{\circ}\text{C}$), and grams of water per kilogram (g/kg) in (a) air, and (b) wood.

measured with strain gauges and recorded. The investigation showed that the movements of a new oak panel and a panel from the seventeenth century were analogous (Klein and Bröker 1990).

Experiments with beech (hardwood) and Scotch pine (softwood) demonstrated that the hardwood has a slightly higher moisture change rate than the softwood, and that the movement of beech samples was therefore larger than that of the Scotch pine samples (Stevens 1961).

The ratio of the area of exposed surface to the volume of the wood also influences the reactivity of the wood. Thin pieces of wood respond more quickly than thick ones, while small pieces respond more quickly than large pieces of equal thickness. When a panel is thinned, as is often done during the cradling process, the ratio of exposed surface to wood is sharply increased; therefore, the diffusion of moisture throughout the bulk of the panel and the response to changes in the atmospheric environment are accordingly accelerated.

It has also been demonstrated that the higher the temperature, the more rapid the rate of moisture transfer. A piece of wood comes to equilibrium about twice as fast at 24°C as at 12°C because the vapor pressure of water at 24°C is twice as great as at 12°C , if the RH is constant.

Finally, the greater the change in RH, the faster the rate of moisture transfer (Buck 1961, 1979).

The preparation of a panel before the painting process must also be considered (for a discussion of historical techniques, see Wadum, "Historical Overview of Panel-Making Techniques," herein). The size and ground may contain hygroscopic materials, such as glue, that also react to changes in RH and temperature.⁴

The behavior of a number of materials found in traditional paintings has been analyzed under the stress of temperature fluctuations and varying RH (Buck 1972; Mecklenburg and Tumosa 1991). Another important result of climatological fluctuations is the changing stiffness of painting materials and mediums in traditional paintings (Michalski 1991).

Changes in RH produce measurable changes in the dimensions of a panel. Research has also shown that paintings change dimensionally as a consequence of temperature, independent of a change in RH (Richard 1991). However, bearing in mind that the thermal expansion of a panel enclosed in a case is small, the conservator should concentrate on keeping the moisture content of the wood constant and thus ensure dimensional stability of the panel.⁵ The unanimous advice given by various authors

holds that a narrow range of temperature and RH change is advisable for the preservation of a panel painting.

Microclimate

Thomson's studies on the different properties related to RH variation with temperature in cases containing wood set the standards for the field (Thomson 1964).

Calculations show that equilibrium moisture content (EMC) is more relevant than RH, since in the microclimate box, the ratio of wood to air will exceed 1 kg of wood per 100 l of air, a ratio that is critical to controlling the humidity of the wood.⁶

Stolow, in particular, provided much useful information and experimental data on tests on enclosed packing cases (Stolow 1965).⁷ Stolow, Thomson, and Padfield were primarily interested in stabilizing RH at a constant temperature (Thomson 1964, 1977; Padfield 1966; Hackney 1987). Apart from Thomson's calculations and experiments showing the RH and temperature changes within cases, as well as the relationships between them, Padfield's contribution to the understanding of the phenomena inside small closed areas must be regarded as part of the standard literature.

If much wood is present, its moisture content determines the RH of the entire volume of the microclimate box. It has been emphasized that the diffusion of water vapor through the case materials and through stagnant air in gaps should be kept in mind when a hermetically sealed case is created (Padfield 1966; Brimblecombe and Ramer 1983). Padfield remarks that water vapor diffuses through air almost twice as fast as oxygen and nitrogen and very much faster than dust particles.⁸

Objections have been raised about the exhibition of objects in almost-closed containers, because of the danger of condensation forming on the glass or object when the temperature suddenly falls. However, Padfield's calculations and experiments confirmed that the stabilizing effect of absorbent materials, such as the wooden panel itself, prevents condensation. Padfield concludes that the conservation of wooden objects in rooms that are heated but not air-conditioned often demands an artificially raised RH in individual showcases. To this end, he recommends using saturated salt or a solution of sodium bromide to stabilize the RH of a showcase.

Toishi describes the common belief that a closed package containing a large quantity of wood dries out when the temperature is raised, even though the wood gives out moisture to balance the dryness of the air. He counters, however, that the quantity of moisture vapor released from the wood when temperature rises is generally so great that it increases the RH (Toishi 1961).

Stolow describes the relationship between EMC and RH, as well as the variations in RH and temperature in sealed cases containing wood. A case at 20 °C with an initial RH of 50% will increase to 53.5% RH when the temperature is increased to 30 °C. If, on the contrary, the temperature were lowered to 10 °C, the final RH would be 46.5%. If the case were not sealed or the air volume were very large, however, he recommends that the internal RH be stabilized with silica gel (Stolow 1967).

To this end, Weintraub tested five different types of silica gel (Weintraub 1981; Stolow 1967). The tests showed no direct relationship between the actual moisture content of a particular sorbent and its relative ability to control the RH of a showcase.⁹

Miura examined sorbents for their static and dynamic characteristics, to estimate their ability to buffer RH changes in a showcase (Miura 1981).

Wood heated to 30 °C lost 2% of its moisture content, which the silica gel or Art-Sorb could easily absorb in order to maintain the RH at stable values (Hackney 1987; Kamba 1993; Wadum et al. 1994).

Microclimate Boxes: 1892–1994

“Sealing a show-case to prevent diffusion and convection and to resist, or deform under, pressure changes up to 0.5 mb would very much reduce the leakage of air and be a major contribution to the conservation of a wide variety of art objects,” Padfield wrote in 1966. This concept, as shall be seen, has been a concern since the end of the nineteenth century.

In deciding the ways and means of creating a microclimate, the conservator should consider the following questions (Cassar 1984, 1985):¹⁰

- What are the requirements of the object, based on its environmental history?
- What is the climate in the gallery where the microclimate case is to be placed?
- What are the functions of the microclimate? Is it to act as a stabilizing, dehumidifying, or humidifying factor to the object?
- What will be the materials used for constructing the display case?¹¹

The importance of using inorganic materials, such as glass and metal, in constructing the case cannot be emphasized enough (Padfield, Erhard, and Hopwood 1982). However, the buffering material can be either organic (wood, paper, textiles) or synthetic or natural derivatives (Nikka pellets, Kaken Gel, zeolite clay, silica gel, Art-Sorb) (Weintraub 1982).¹²

Thomson’s recommendation of 20 kg of silica gel per cubic meter for buffering purposes in exhibition cases has been regarded as a good starting point (Thomson 1977), but in certain circumstances, the same result may be achieved with less. Recent research, however, questions the recommendation of using any buffering material at all in microclimate boxes (Wadum et al. 1994).

Display materials also influence the buffering ability of a display case and should therefore be chosen carefully. They should all be conditioned before installation. Conditioning hygroscopic materials may require up to one month’s exposure to the desired RH before the equilibrium wished in the microclimate environment is achieved (Fig. 2a–c).

Microclimate boxes with added buffers

Even though most authors thought that wood itself could be used as a buffer, there was often a tendency to add an extra buffer to stabilize the internal RH of the microclimate box.

In 1933 a patent appeared for the use of salt-hydrate pairs as regulating substances in cases and picture frames. The humidity should be controlled through a low rate of air exchange, so that all the entering air passes over certain salt-hydrate pairs. In this way, one salt may absorb moisture from air that is too humid, while the other salt will conversely release moisture if the air is too dry (Wilson and Barridge 1933). Shortly thereafter, in

Figure 2a–c

Three main principles behind the construction of a microclimate box: (a) a box containing a panel painting and buffer material; (b) a box containing only a panel painting; and (c) a box containing a panel painting and an altered gaseous content.

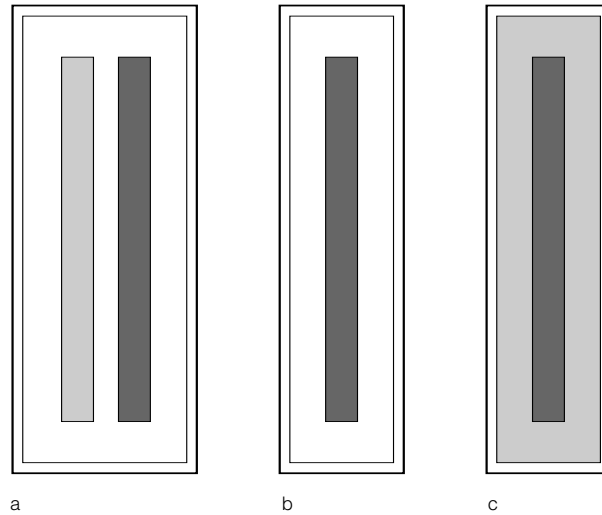

1934, MacIntyre published test results to show that RH in a poorly sealed display case is still more stable than the RH in the surrounding room. He further demonstrated that the hygroscopic panel, frame, and fabric lining of the case would improve this stability so that even with a 1 mm gap around the glass base, a fairly constant RH could be maintained during the week of monitoring (MacIntyre 1934). The results were applied to an air-conditioning system for Mantegna's cartoons at Hampton Court Palace.

In 1934 Constable proposed an alternative to buffers. The idea was to feed conditioned air into the frame (or case) by means of pipes; however, this was dismissed at the time on the presumptions of bulk and inconvenience (Constable 1934). The idea was nevertheless put into practice approximately fifty years later (Lafontaine and Michalski 1984).¹³

In 1936 Curister enclosed a panel painting attributed to Hugo van der Goes. Salts were kept in trays within the base of the double-glazed standing vitrine, which was capable of keeping a stable RH indefinitely, provided the exchange rate with the exterior was not too great.¹⁴ Small glazed openings were made at the top of the cases, through which enclosed hygrometers could be monitored. Before the construction and assembly of the microclimate box, the wood used in the construction of the cases and frames was carefully seasoned and conditioned in an atmosphere of the agreed moisture content. During the most difficult climatological months, the sealed cases showed a stable internal RH of 55%.

More than twenty-five years would pass before a new description of a microclimate box for a panel painting appeared (Sack 1963–64). Sack describes how a controlled environment was made for a panel painting and kept stable during a low winter RH of 12–28%. A large sealed wooden case with a double glass door was constructed that held pans containing a saturated solution of magnesium nitrate hexahydrate. A small fan distributed the conditioned air to all areas within the case. In this manner, the RH was held stable between 50% and 52%.

Shortly after, Stolow published his aforementioned studies of the humidity and thermal properties of a sealed case (Stolow 1967).¹⁵

If the elements (case and painting) are in equilibrium with the environmental RH and temperature when the case is sealed and then subsequently placed in another environment, a new equilibrium will

develop within the case after a certain time.¹⁶ Thus the sealed case—when tightly packed with conditioned wood and similar hygroscopic or moisture-sensitive components—can maintain reasonable RH control over temperature changes.

There are two instances to which the above conditions do not apply and where more complicated formulas must be used. The first arises if the case is not tightly packed; the second occurs when the internal air volume is relatively large compared with that of the humidity-sensitive materials. If the air volume is very large, the moisture properties of the internal air dominate the relationship between RH and temperature; in this case an increase of temperature will cause a decrease of the RH, and vice versa. Stolow advises that silica gel be used to stabilize the RH, as the response of the gel to temperature is negligible.

Based on the studies of Thomson and Stolow, Diamond's 1974 article on a "micro-microclimate" gave the first description of a microclimate box for a panel painting on display. A sixteenth-century French portrait from the school of François Clouet was placed in a showcase. It appeared that with a maximum fluctuation of temperature in the galleries of 11 °C, the RH should vary by less than 4%.

Accordingly, a hardwood box was constructed and fitted at the front with glass, which was puttied to make an airtight seal. A chipboard back was made. This procedure yielded a box of approximately 13.7 l volume, containing about 220 g of wood (picture and frame), which, according to Thomson's figures, should have produced a near-stable environment. The wood of the case was left uncoated so that it could play its part in absorbing and giving off moisture. The whole box was conditioned for two weeks to 55% RH ($\pm 5\%$) and 20 °C (± 2 °C).

The fact that the picture showed signs of distress very soon after being treated suggested either that it was sensitive to changes of RH of less than 4% or that the design of the box was faulty.

The construction of a completely airtight box was impossible, due to finances. Therefore, a buffer was chosen to reduce the RH fluctuations. The principles involved were those laid out by Stolow (1966). The box was fitted with panels of silica gel held in a grid. The grid was crucial, as it spread the silica gel over the largest area possible within the box.¹⁷ The open box and all its materials were left for four weeks to reach equilibrium in a stable environment.

The environment was controlled with a small hygrometer and was stable around 41% RH ($\pm 4\%$) over two months. Variations inside the box were no greater than 5%, so the box was considered a safe container for the painting.

The box protected the painting from considerable fluctuations of approximately 20% during this period. Thus, only minor changes in RH took place inside.

The same year Toishi and Miura described how the *Mona Lisa* from the Louvre was exhibited for fifty days in the Tokyo National Museum (Toishi and Miura 1977). Throughout the run of that exhibition, the painting was enclosed in an iron case equipped with a double-panel glass window and lined with a 75 mm layer of glass. To maintain a stable RH of 50%, zeolite was placed in the case. The zeolite was found to be capable of absorbing various gases such as sulfur dioxide, hydrogen sulfide, ammonia, carbon dioxide, and formaldehyde. The zeolite had been brought to a humidity equilibrium in air at 60% RH (Kenjo and Toishi 1975).

Probably the most-cited contribution on controlling microclimates was written by Thomson in 1977. He derived a formula with experimental support to predict the RH changes inside an unsealed exhibition case that contained a buffer such as silica gel. The formula showed that a well-constructed case (containing about 20 kg silica gel per cubic meter of case volume) should constrain seasonal humidity variation within reasonable limits and, in some climates, make air-conditioning unnecessary. The practical solution recommended by Thomson was to make a showcase of non-moisture-permeable materials and snugly fitting closures, possibly gaskets.

For RH conditions above 50%, silica gel offers little advantage over wood, as its *M* value is about the same.¹⁸ However, at lower RH values silica gel is the best buffer.

In this article Thomson does not take fully into account the change of temperature; his focus is mainly on the RH changes. Tests of the half-time of the case were made under constant temperature levels. Also, the tests were conducted only with silica gel, not with other buffer materials, such as wood.

The leakage rate for the case is important. Thomson refers to important studies by Padfield on the problem of diffusion through various materials (Padfield 1966).¹⁹

Sack and Stolow (1978) reported that in a case designed in 1963 to exhibit a German panel painting in the Brooklyn Museum's main entrance lobby (an area of the museum with a particularly erratic climate), a saturated solution of magnesium nitrate hexahydrate proved to be effective in controlling the RH at 50–52%.

In another situation, a similar box served to control the microclimate around a painting on a thin wooden panel. This microclimate box was constructed to protect a fine Fayum panel on loan to the Brooklyn Museum. The intention was to design a case as airtight as possible to preserve the required level of RH, independent of external variations. The Fayum painting (44.5 × 28.5 × 0.2 cm thick) was painted on thin wood. The wood had been bent to conform to the double convex contours of the original mummy case.²⁰

It was decided to enclose the Fayum painting in a case kept at a constant RH of 50%. Preconditioned silica gel would serve as the RH stabilizing agent in the case. The case consisted of an outer display box and an inner, airtight, metal-and-glass chamber. Inside the case, a wooden frame was covered with fabric containing the preconditioned (50% RH) silica gel, with the painting secured 4 mm in front of the silica gel panel. A section of paper-strip RH indicator was placed in the corner of the case to allow continuous monitoring of the internal RH. The painting flattened considerably from its convex warp while sealed inside this case.

Although the case was almost airtight, a very slow moisture exchange with the exterior could still occur over time. This possibility made it necessary to recondition the silica gel annually. Since it was time-consuming to remove, recondition, and replace the silica gel, a second panel was made. Kept under secure airtight conditions, it could be installed as a replacement to the "worn-out" panel, which would be reconditioned and readied for the next annual replacement.

Acclimatization of two large (922 l) vitrines of air containing five icons was carried out to attempt the difficult task of stabilizing the gallery environment at 50–60% RH (Schweizer and Rinuy 1980). To keep the environment stable, the recommended amount (20 kg m⁻³) of silica gel was

placed in a honeycomb tray and covered with a nylon screen. With the screen facing the interior, the tray formed the back of the case. The results showed that the temperatures in the gallery and showcase were approximately the same at all times. In contrast, the RH within the cases remained stable despite changes of 44–74% in the RH outside the showcases. Evaluation of the amount of silica gel actually required to keep the RH level stable in the vitrine led to a recommendation of 10–15 kg m⁻³—almost half of what Thomson advised. It was also noted that the conditioning of the silica gel should be at an RH value 5% higher than what was actually desired in the case.

At the Sainsbury Centre for Visual Arts at Norwich, England, the use of a mechanical system dependent on electricity was considered impractical to assess RH control employed within showcases (Brimblecombe and Ramer 1983).²¹ The use of a saturated salt solution, which is most effective when auxiliary support is provided by an electric fan, presented the same drawbacks as the fully mechanical system. The use of silica gel enabled the creation of a self-sufficient system without the need for electrical support.

To monitor the mechanism of air exchange between the interior and the exterior of the case, an experiment was designed using a tracer-gas method to monitor the concentration of various gases over time within a standard-sized display case.²² Padfield's indication that the air-exchange process occurs essentially by diffusion was confirmed (Padfield 1966). Additionally, Thomson's studies showing that the exchange of air within a display case—and hence water-vapor variation—occurs exponentially were also verified (Ramer 1981, 1985).

The conclusion reached, based on a calculation of the hygro-metric half-time, was that Thomson's recommendation to use 20 kg m⁻³ of silica gel was valid.

The diffusion of air is the primary cause of RH variation within showcases; therefore, good construction of cases is essential (Ramer 1981, 1985).

Also in 1981, a number of case histories about controlled-climate cases were presented by Stollow (1981). One such case involved a large panel painting and its predella by Neri di Bicci. The acrylic case enclosing the panel was relatively small in air volume compared to the object volume, having only slightly larger dimensions than the artwork to allow for maximum buffering action of the silica gel. The estimated weight of the panel and the predella was 250 kg. After consideration of the panel painting and the supporting materials (i.e., fabrics, wood), it was deemed necessary to place inside the case approximately 200 kg of conditioned silica gel, which was held in place by a screened panel covered with linen fabric.

With the past environment of the panel painting considered, it was decided to establish a slightly higher-than-average RH (45%) within the case. The EMC of the silica gel was periodically tested during the conditioning procedure to verify, via sorption curves (isotherms), that the 45% RH operating level had been reached.

Electronic probes were considered to monitor the interior of the case, but because they are costly and require frequent calibration, they were abandoned in favor of paper RH indicators. After one year of operation, it was shown that the internal RH level had been kept at a fairly constant 40–43% RH, despite wide variations in the gallery climate.

A further example of a specific microclimate box is to be found in a description by Knight of the Tate panels in the Church of All Hallows

Berkyngeschirche by the Tower (Knight 1983). A box was made of Perspex (known in the United States by the trade name Plexiglas), with a sheet of aluminum as a backing board. Steel brackets attached the box to the wall, thus leaving an air gap between the back plate and the wall.

Recommendations by Stolow and by Sack and Stolow provided the basis for the humidity-control requirements of the box (Stolow 1977; Sack and Stolow 1978). Silica gel was placed in the box in small narrow trays that could be individually removed for reconditioning. After installation, a small hygrometer showed that the interior RH was maintained at a level of 56–58%.

The variation in RH in an experimental exhibition case that was intentionally not sealed or airtight was monitored over two years (Schweizer 1984). The RH of the surrounding room varied considerably (20–70%), but the RH inside the case, which contained silica gel, maintained acceptable stability (40–58%). This type of box, therefore, would prove very useful in regions with hot summers and cold winters. The amount of silica gel required was based on Thomson's formula of 20 kg m^{-3} .

Also in 1984, a microclimate box was presented by Ramer for a seventeenth-century panel painting from the Netherlands (Ramer 1984). The goal was to create—with a more aesthetic design than previous microclimate boxes—a humidity-controlled display case for the painting that covered both the panel and frame. The new microclimate box was to be fitted into the extended rabbet of the picture frame, making this the first occurrence of its kind since the late nineteenth century (Simpson 1893) (see the section below entitled "Microclimate boxes that alter the gaseous content").

Practical requirements demanded a low maintenance level and easy recharging of the silica gel humidity buffer. The RH requirement within the case was 55%. The silica gel amount was determined according to Thomson's formula of 20 kg m^{-3} .

The microclimate box was made of inert materials (e.g., aluminum), and the glazing at the front was composed of 5 mm polycarbonate sheeting (Lexan). As in previous designs, the tray of silica gel could easily be remounted and reconditioned. The box was designed by B. Hartley, A. Southall, and B. L. Ramer.

Thirteen Fayum mummy portraits and a panel painting of Saint Luke by Simone Martini, all housed in the J. Paul Getty Museum in Malibu, California, were placed in special cases that had a higher humidity than normally maintained in the paintings galleries (Rothe and Metro 1985). An absolutely airtight microclimate box was constructed, with care taken to make sure that it wasn't too visually overpowering.²³ The case consisted of three basic sections: a back panel, a front bonnet (vitrine), and a silica gel container. Art-Sorb was selected as the buffer in accordance with comparative performance statistics published by Weintraub and Miura (Weintraub 1982; Miura 1981).

For the Simone Martini panel, 4 kg (dry weight) of Art-Sorb was placed in the gel container and conditioned in a humidity chamber to 66% RH. This amount is four times greater than recommended by Thomson (1977) for a case of this size. The showcase had been on display since March 1983 in a temperature- and RH-controlled gallery. The RH in the gallery was always 14–16% lower than the RH inside the case.

The same construction was used for the Fayum portraits, except for the back panel, which was replaced by a Formica panel. The silica gel con-

tainer was made out of birch with a silk-screen fabric stretched over the front and back. The gallery used for this display is open to the outside environment during public hours, a factor that influenced the RH, which ranged from a low of 37% to a high of 68% during the test period. During the year, the temperature ranged from 20 °C to 27 °C. The mummy portraits required cases that were capable of maintaining an ideal environment of 50% RH, with minimal or no fluctuations. After observation of the hygrometers in the cases, it was ascertained that the RH never varied more than 2%. Thus, it was not necessary to recondition the Art-Sorb for two years. Because the cases were constructed of Plexiglas, the objects were clearly visible and could be lit from the outside without any apparent change in temperature.

Dissatisfaction with the microclimate boxes previously used by the Kunsthistorisches Museum, Vienna, led Ranacher (1988) to present a slightly different idea.²⁴ In his concept, silica gel could be renewed without dismantling of the box, and an electronic device enabled convenient external checking of the internal environment (Mayer 1988). The back and sides of the box were made of wood to aid in stabilizing the internal moisture content. The front of the box consisted of a Plexiglas hood, which was mounted on the frame of the backing board. The frame of the painting on display would be mounted over a hole in an internal wooden board covering the backing of silica gel. The amount of buffer material (7 kg m^{-3}) was determined by Ranacher's own experimentation, not chosen according to previously recommended high values of $10\text{--}20 \text{ kg m}^{-3}$, or recommended low values of $1\text{--}2 \text{ kg m}^{-3}$ as recorded by Miura in his laboratory tests (Miura 1981). The ratio used in Vienna had previously been proved adequate for maintaining a stable RH of 50% within a microclimate box that hung in a gallery having temperature fluctuations of $14\text{--}23 \text{ }^\circ\text{C}$. The built-in electronic device for monitoring RH and temperature levels was invisible to the public. Personnel could read the electronic data by plugging in a wire at the bottom edge of the box.

At the United Kingdom Institute for Conservation conference, Cassar and Edmunds individually presented microclimate boxes designed to fit within the frame of the painting, similar to those presented by Ramer in 1984 (Cassar 1988; Edmunds 1988). Cassar enclosed a panel painting in a buildup of the original frame, which permitted the manufacture of a glazing (Perspex) and backing. The environment of the box was kept at a stable RH through the presence of an Art-Sorb sheet placed behind the painting. Edmunds constructed a closed box with low-reflection glass at the front and with Perspex sides and backing. A Perspex grid containing conditioned silica gel crystals in small sacks could be stored behind the panel painting. A hair hygrometer and, later, Grant Squirrel Data Loggers were used to monitor the box interior and surrounding environment. The data showed that the inside RH remained stable for a considerable period at various ambient conditions without recalibration of the silica gel. Cassar also reached the same conclusion.

Bosshard and Richard also recognized the disadvantages of microclimate boxes that enclosed both the painting and its frame (Bosshard and Richard 1989). A box enclosing only the painting was developed and widely distributed by Johnson and Wight in the beginning of the 1980s in California.²⁵ This box was further refined, in conjunction with an empirical trial with the Thyssen-Bornemisza Collection, to become a standard-climate vitrine. This new microclimate box was flat and could, therefore, be fitted

into the frame of the painting (Bosshard 1990). With low-reflection glazing, the box could hardly be seen. The rabbet of the frame often had to be extended to make room for the box, but in situations where this action was not desirable, the sides of the vitrine could be made of a thinner metal foil instead.

Art-Sorb granules were preferred to Art-Sorb sheets, as the gel is more reactive in absorbing and desorbing moisture. The inside of the box was made according to the specifications: one-third panel, one-third silica gel, and one-third air.

Because RH always drops after the box is closed, the Art-Sorb was conditioned to a RH of 3% higher than desired. A paper RH meter was placed in back, making it possible to check the RH inside the box at any time. Foam rubber on the silica gel frame pressed the painting forward to the front of the box. At present, more than fifty-eight panel paintings—on loan or in the Thyssen-Bornemisza Collection—are kept in these vitrines.

Simultaneously with the empirical trial in the Thyssen-Bornemisza Collection, Mervin Richard carried out lab tests at the National Gallery in Washington (Richard 1993). The results showed that the thicker the walls of the box, the greater its stability. The interior RH depends on the amount of the buffer material, and the greater the difference between RH outside and inside the case, the quicker the inside will change to a new equilibrium.

Thomson recommended 20 kg m^{-3} of silica gel. As the Art-Sorb in this case was deliberately over the requirements of the air volume, “overkill” was established. Richard proved with his climate chamber that a temperature change of $10 \text{ }^\circ\text{C}$ resulted in a change of about 2% RH inside the box, depending on its size and capacity to absorb the temperature change.²⁶

In 1990 a microclimate box to be fitted within a frame was constructed in the Mauritshuis, The Hague, largely following the concepts of Ramer, Bosshard, and Edmunds (Wadum 1992).²⁷ The glazing was, however, always a layered safety glass that enabled the box to travel with minimum risk.²⁸ At first the box included silica gel or Art-Sorb sheets to stabilize its internal RH during display and transit (Wadum 1993).²⁹ Between the glazing and the front of the painting, in the rabbet, a grid was placed along all four sides allowing convection of the air from front to back and vice versa.

Small built-in microprocessor loggers monitored the RH and temperature from the time of installation until the painting was returned after loan.³⁰ The printout showed that the RH stayed stable within 2%, despite temperature fluctuations of more than $10 \text{ }^\circ\text{C}$.

Simultaneously with the Mauritshuis, the Rijksmuseum in Amsterdam was also developing a microclimate box. This box, a low-budget variant, was initiated and constructed by Sozzani, who needed a simple, easy-to-mount box to fit into the frame (Sozzani 1992). The box was constructed of safety glass that was mounted and sealed in the rabbet of the frame. Behind this, the painting was mounted in the usual way. Thin wooden battens were built up on the back of the frame, allowing enough depth in the rabbet for the insertion of a sheet of Art-Sorb behind the panel. The stainless steel backing sealed off the box with airtight gaskets.

The primary advantage of this type of box is that the rabbet never has to be extended, a requirement that would be undesirable in many situations. The previously used microclimate boxes from California required

some manipulation of the frame.³¹ The Rijksmuseum boxes also proved effective when monitored with humidity indicator strips or small hygrometers, all of which indicated a stable RH within the boxes in the museum environment.

Extensive studies undertaken by Richard have confirmed that temperature changes affect panel paintings much faster than do RH variations (Richard 1994). Although he concludes that silica gel has no effect on the temperature changes, he nevertheless recommends that the gel remain in use for microclimate boxes. Drawing on the assumption that virtually all microclimate boxes leak, Richard states that silica gel plays an important role in stabilizing the RH in display cases used in unsuitable environments for extended periods.

Microclimate boxes without added buffers

A more recent approach to the construction of microclimate boxes relied on the hygroscopic behavior of the wood panel itself as a stabilizing factor within a small volume of air. Such boxes were not kept at a stable RH through added buffers but instead maintained their own internal moisture equilibrium at changing temperatures.

A critical approach to the consistently recommended use of a moisture buffer in small display cases was presented by Ashley-Smith and Moncrieff (1984). Their experiences in the Victoria and Albert Museum in London showed that the silica gel in a showcase neutralizes the short-term RH fluctuations but does not compensate for seasonal changes. Ashley-Smith and Moncrieff concluded that for wooden showcases, silica gel gives poor results in relation to the time and expense required to purchase, prepare, and handle it, as well as to design and build showcases to accommodate it. They stated that an ordinary showcase without silica gel fares nearly as well—or as poorly—in reducing short-range fluctuations. The same conclusions were drawn in reference to some old-fashioned walnut cases in the Royal Ontario Museum, Toronto, that proved remarkably effective in slowing moderate fluctuations of RH (Phillimore 1979). For best results, a well-sealed case made completely of metal and glass or plastic is usually essential (Brimblecombe and Ramer 1983). However, for the Victoria and Albert Museum, wooden case vitrines serve in themselves as useful, additional buffers (see Cassar and Martin 1994).

Also in the early 1980s a special type of microclimate box was created by Padfield, Burke, and Erhard (1984). A cool-temperature display case was made for a vellum document placed in a close-fitting airtight container. The document required a stable temperature of $\pm 16^\circ\text{C}$, some six degrees cooler than the gallery, and an RH of 40–50%. The box maintained a nearly constant RH after cooling; however, special care was necessary to minimize temperature gradients. The case performed satisfactorily for one year with no change in internal moisture content.

The simplest method possible was chosen for displaying this document. It was sealed inside a thin, airtight container that was cooled by means of the Peltier effect.³² The refrigeration system of the box consisted of two coolers at the bottom of the aluminum tray holding the microclimate box.

A close-fitting, airtight enclosure has many advantages for the temporary exhibition of flat pieces of vellum or paper. It can be designed to maintain a nearly constant moisture content and a safe RH. At room

temperature, paper contains thousands of times more water than an equal volume of air does. In a sealed box full of paper, therefore, it is the paper that controls the RH of the surrounding air, if both are of the same temperature.

Based on the psychrometric chart, it was obvious that a container holding more than 1 g of paper per liter of air has a reasonably stable RH as the temperature varies (a rule of thumb that, incidentally, holds true over the whole range of ambient temperature). This conclusion applies only to a slow temperature change imposed uniformly to the paper and box.

It is important to remember that absorbent material such as paper or silica gel only functions as an RH buffer if it is at the same temperature as the air or object to be buffered. To buffer for eventual air leakage of the sealed box, extra paper was enclosed in the box to increase the buffering capacity.

Apart from using inert material for the inside of the box, a further precaution against air pollution involved using paper containing calcium carbonate to absorb acid gases.

In 1987 Hackney warned against enclosing buffering materials such as silica gel in small, sealed environments. He underlined, as have authors before him, that the equilibrium of silica gel or similar buffers is not dependent on changes in temperature (Stolow 1965, 1967; Thomson 1964, 1977; Weintraub 1982). On the contrary, hygroscopic materials such as wood were characterized by relative equilibrium, showing a higher RH at higher temperatures, and vice versa.

Despite these developments, the creation of microclimate boxes continued with added buffers such as silica gel or Art-Sorb (as discussed above in the section entitled "Microclimate boxes with added buffers"). The tradition continued, under the influences of guidelines laid out by the authors mentioned above, to keep the internal RH stable under all circumstances.

Richard reported in 1991 that in closed cases, falling RH levels caused by temperature decreases should not cause alarm, noting that several publications have emphasized that it is not beneficial to maintain stable RH levels for hygroscopic works in transport if temperature changes are anticipated at the new location. If, for example, a painting were moved from 50% RH and 20 °C into a very cold gallery, a lower RH must be maintained if the EMC is to be kept constant within the object.

Users of microclimate boxes seemed fairly reassured by the stable RH values produced through the use of added buffers such as silica gel or Art-Sorb. However, considerations regarding the effects of temperature fluctuations on the wood of the enclosed panel developed into an extensive test program set up by the Mauritshuis, The Hague; the Central Research Laboratory for Objects of Art and Science (CL), Amsterdam; and the Rijksmuseum, Amsterdam (Wadum et al. 1994).

The tests at the CL demonstrated that buffering material should be avoided in small microclimate boxes. Otherwise, fluctuations in the temperature would initiate a breathing process between the non-temperature-reactive silica gel or Art-Sorb and the panel.

Boxes made of inert material proved effective in maintaining stable environments for the hygroscopic material inside. A box made of an inert front and back, but placed in the wooden rabbet of the frame, also provided effective maintenance against fluctuations of 10–30 °C. Long-term (i.e., more than eight hours) low or high temperatures were not

tested. RH fluctuated between 30% and 70% without any influence on the interior climate. The boxes were well sealed to prevent leakage.

The Mauritshuis microclimate box now uses polycarbonate sheets as a backing; because buffer material is not used, the reverse of the painting is left visible so that the courier or other museum staff can examine it without removing it from the microclimate box.³³

Dimensional movement of different types of wood in closed cases, with and without silica gel, was studied by Kamba (1993). He states that the dimensional change of the wood inside the box without silica gel was less pronounced than that of the wood in the silica gel-buffered case. Kamba's studies thus confirmed the results from the tests at the CL, in which an equilibrium between wood and the surrounding air at different temperatures was attained without added buffers.

For these reasons the most recent microclimate boxes for panel paintings at the Mauritshuis and the Rijksmuseum are now made without any added sorbent material. The buffering role of the panel itself is regarded as sufficient for the small, enclosed environment of a microclimate box. However, care is taken to ensure stable temperatures around the microclimate box, whether it is on display in the gallery or in transport (Wadum et al. 1994). To this end, the research at the CL also showed that maintaining an open air space of 2 cm or more between the microclimate box and the wall increases considerably the stability of temperature within the box (see also Ranacher 1994). Thermally insulated transit crates may maintain a relatively stable temperature inside the microclimate box on long journeys (Fig. 3a–d).

Microclimate boxes that alter the gaseous content

Apart from one very early foray, the use of microclimate boxes with an altered gaseous content has become popular only in the last decade. This new interest arose from the need to reduce the deteriorating effects of oxygen.

The first known attempt to make a microclimate box was in 1892 in England by Simpson, to protect a painting by J. M. W. Turner in the Victoria and Albert Museum (Simpson 1893). The characteristics—tailored to fit the specific painting—of this sealed, airtight box were very similar to a modern microclimate box. Simpson's box was even intended to be fitted into the original gilt frame and hung in the usual manner. The front was composed of glass; the back comprised glass, metal, or other materials. In Simpson's box, nozzles were placed at the bottom for attachment to an exhauster, which could extract air from the box to create a vacuum around the picture.

Figure 3a–d

Four main types of microclimate boxes: (a) a box containing a panel and buffer and no framing, (b) a box encapsulating a framed panel and buffer, (c) a framed box containing a panel and buffer, and (d) a framed box containing only a panel.

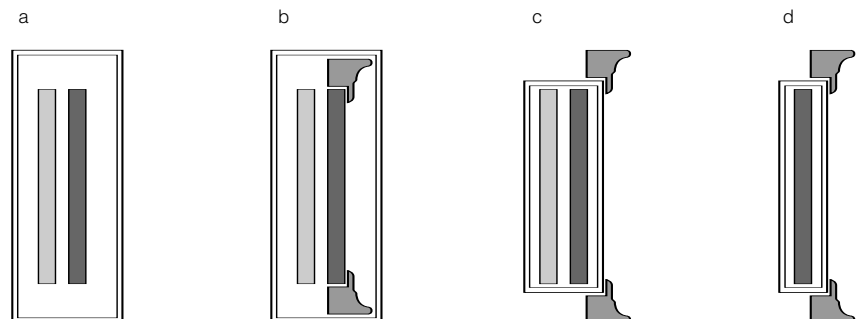

Simpson concludes his description by asserting that the color of the picture in the box would be hitherto immune to light, sun rays, dampness, or other damaging external influences.³⁴ Indeed, time has shown that the Turner painting is in excellent condition to this day; until the present, the box has not been opened. Although hardly subject to vacuum for very long, Simpson's box represents the first attempt to create an altered gaseous content around the object enclosed in the microenvironment.

The first inert gas display case was described by Byrne (1984). An effigy figure from Easter Island was placed in a round Plexiglas tube acting as a display case. The ends were sealed with Plexiglas disks fitted to the tube. Silicone rubber served as a gasket. The tube was 20 cm in diameter; its walls were 6.3 mm thick. To avoid the presence of water vapor around the effigy figure, the tube was charged with nitrogen gas to exclude oxygen and moisture. A modified aneroid barometer monitored the pressure within the case and confirmed the presence of a stable charge of nitrogen gas. Four years later the case showed a loss of pressure, so nitrogen gas was added again. A humidity indicator strip was placed in the case, and future recharging with nitrogen was accomplished by first bubbling the gas through a water bath.

The use of Ageless as a means of generating low-oxygen atmospheres for the treatment of insect-infested museum objects is discussed by Gilberg (1990). Ageless is a type of oxygen scavenger that is described by the manufacturer to be a mixture of finely divided moist iron, (ferrous) oxide, and potassium chloride, a combination that rapidly absorbs atmospheric oxygen. The oxygen concentration in a microclimate box can be reduced to less than 0.05% as the introduced Ageless quickly reacts with any oxygen leaks. Ageless can also reduce the oxygen concentration in a closed environment to less than 0.01% and can maintain this level indefinitely, depending on the permeability of the packing material.

Ageless is available in different package sizes that correspond to the amount of oxygen to be scavenged (for example, Ageless Z-200 is capable of absorbing the 200 ml of oxygen contained in 1 l of air). Ageless-Eye is an oxygen indicator in tablet form that changes color in relation to the absence or presence of oxygen. Tests in which insect-infested objects were kept at 30 °C and 60% RH resulted in convincingly stable, low oxygen levels and stable RH.

Ageless is being used to prevent deterioration of rubber, which becomes brittle as a result of ultraviolet light, ozone, and oxygen (Shashoua and Thomson 1991). After some rubber objects in the British Museum, London, were sealed in bags, the oxygen was reduced; an investigation into the deterioration rate of the objects showed positive results.

Further investigations on the uses and reactions of Ageless were undertaken at the Getty Conservation Institute to develop hermetically sealed, inert, gas-filled display and storage cases (Lambert, Daniel, and Preusser 1992).

No matter how well cases are designed and constructed, some air can always enter. If their value as oxygen-free chambers is to continue, the leaking cases must be reflushed with nitrogen or some other inert gas. After the original flush, the oxygen-free life span of the case can be greatly extended by an oxygen scavenger placed in the case. Calculation of the approximate lifetime of a case is obtained by dividing the oxygen-absorbing capacity of Ageless in the case by the leak rate per day.

The Getty Conservation Institute studies were conducted on packets of Ageless-Z in boxes, in which RH-conditioned nitrogen was produced by control of the mixing ratio of dry nitrogen obtained from the cylinder, to humidified nitrogen—the result of dry nitrogen bubbling through water at room temperature (Byrne 1984). The test chamber was initially flushed with nitrogen until the oxygen reached the 1000–9000 ppm range. At this point Ageless was rapidly inserted and the test chamber hermetically sealed. The RH inside the chamber was maintained at 52% with saturated salt solutions (magnesium nitrate). This research showed that Ageless reacts rapidly and thoroughly with oxygen in a sealed case that is filled with an inert gas, and that has an optimal RH above about 50%.

Sealed cases filled with inert gas prevent the oxidation of the objects placed therein. In small flexible containers with little air content, Ageless can perform well in spite of slight warming. It is hazardous, however, to place Ageless in a large rigid case containing air because of the heat produced and also because of the risk of implosion when the oxygen (20% of air) is removed. A sealed case filled with an inert gas should have flexible bellows attached, to compensate for temperature and pressure fluctuations in the museum atmosphere.

A slight color change in cinnabar, litharge, and sienna has been observed on objects in nitrogen-filled sealed cases (Toshiko 1980). There is good evidence, however, that a nitrogen atmosphere retards the fading of watercolors.

The Getty Conservation Institute, as well as Gilberg and Grattan, concluded that Ageless is a rapid and efficient oxygen scavenger (Gilberg and Grattan 1994). Its use in an inert, gas-filled, hermetically sealed display case with a moderate leak rate should maintain the oxygen content at a very low level for several years. An environment with an RH of 53% or above is recommended. Both the level of the oxygen content and the interval after which an Ageless-equipped case will require a replacement and flushing can be readily predicted if the case leakage rate is known.

Measuring Devices

There are many devices for measuring RH; they range from aspiration and sling hygrometers to thermohygrographs, dial hygrometers, cobalt salt strips, and data loggers of various kinds. Thomson and Brown have described the pros and cons for a number of devices, showing how unreliable they can often be, either because of an instrument's poor accuracy or lack of calibration or because of mistakes made by the person manipulating the instrument (Thomson 1981; Brown 1994). Suggestions for the monitoring of showcases include a special built-in sensor with digital read-out or a printer (Mayer 1988). A number of small measuring devices have also been used to keep track of activity inside the microclimate boxes.

Diamond placed a small Edney dial hygrometer inside the box, after checking it for accuracy against a sling psychrometer. Diamond's microclimate box covered both picture and frame, so the hygrometer could be placed flat at the bottom of the vitrine, enabling the viewer to monitor the environment from the front of the box (Diamond 1974).

The vitrines used by Rothe and Metro of the J. Paul Getty Museum had been tested with small thermohygrographs from Pastorelli and Rapkin (Rothe and Metro 1985).³⁵ They were not as accurate as much larger and more sophisticated thermohygrographs but were, in this

instance, proved to be reliable, since they provided warning about air leakage. According to Rothe and Metro, the only evident disadvantage is a necessity for frequent monitoring because no printout (that can be read later) is produced.

Paper RH indicators with impregnated bands of cobalt salts change from pink to blue in relation to the ambient RH. This type of indicator has been used by most modern authors, and a thorough investigation into their effectiveness has indeed proved them to be reliable and long lasting (Daniels and Wilthew 1983). A reference color against which to compare the RH values on the strips is recommended.³⁶ As dial RH measuring instruments have hair, paper, or special plastic sensing elements, they need frequent recalibrating; strips, in contrast, are not altered over time.

Placement of the cobalt strips next to the painting within the vitrine is necessary to obtain an accurate reading. Since this is aesthetically not a very pleasant solution and distracting for spectators, other placements have been explored. The cards have often been placed on the back of the boxes, but microclimate boxes that fit within the frame can only be monitored when the painting is turned, a procedure that requires much time-consuming and unnecessary handling of the object in order to track the changes in the microclimate box.

When daily monitoring of a microclimate box and its painting is not feasible, a continuous record of activity is possible only with small data loggers. Inspired by the National Gallery in Washington, D.C., the Mauritshuis began monitoring the RH and temperature within microclimate boxes using ACR data loggers (Wadum 1992).³⁷ The small logger was mounted behind the panel on the inside of the backing lid of the microclimate box, with its communication socket in the frame of the vitrine. This method allowed for initialization of the logger inside the box without its being opened. When the painting was traveling, the courier made backups of the logged RH and temperature after arrival at the destination museum.³⁸ Then, a new interval of logging (typically around three months) was set for the loan period to follow.³⁹ The courier and the registrar could then evaluate the transit period and eventually arrange for improvements before the return of the painting. These small loggers make it possible to keep a complete record of a specific painting's climatological history, starting from the moment of installation.⁴⁰

Aesthetics

Discussing the aesthetics of microclimate boxes can initiate a heated dialogue between most curators and conservators, as well as among the public. Most people would probably prefer being close to an object of study, without having the feeling of looking into a vitrine. Paintings in vitrines seem remote—the vitrine forms a barrier between the spectator and the artwork.

As previously discussed, microclimate boxes have developed from vitrines hanging on the wall, enclosing painting and frame inside, to small boxes placed behind and within the frame. This evolution clearly reflects the goal of distracting the spectator as minimally as possible. De Guichen and Kabaoglu once made an ironic list of recommendations regarding the optimum manufacture of a showcase (de Guichen and Kabaoglu 1985). Almost all of their “guidelines” could also apply to the microclimate boxes (to wit: one suggestion, to “be sure to display the locking mechanism

prominently,” reflects the assembling screws or painted backing boards that make a disturbing impression on many a microclimate box).

During the installation of a painting in a microclimate box, dust can become a nerve-racking nuisance (“Avoid sealing the showcase too tightly, because exhibits always look better when covered with a uniform coat of dust,” de Guichen notes). Many microclimate boxes on display do show small specks of dust on the inside of the glass, and cleaning them out is impossible without dismantling the whole box, a practice usually acceptable only when the box has returned to the controlled environment of the lending museum.

The protective Perspex or glass is another main issue. Many microclimate boxes recall de Guichen’s “helpful” suggestion to “polish the glass of your showcase to a mirror finish.” Any glazed painting, particularly a darker one, reflects at certain viewing positions. Perspex has the most reflective qualities; coated and low-reflection glass can reduce the amount of reflection to a minimum. In some instances, detection of the protective glass in front is impossible without specific inspection (Saunders and Reeve 1993).

The small (366 × 257 mm) François Clouet picture that Diamond placed in his microclimate box is aesthetically and physically delicate (Diamond 1974). It has an extremely finely wrought rosewood frame inlaid with silver and mother-of-pearl, “clearly not the sort of thing you just put in a box and screw to the wall,” he states. The proportions of the box, as well as the color and texture of its lining, were thus critically considered in the design; ultimately, the museum agreed that the picture actually benefited from its more aesthetic installation, as well as its new, larger presence on the gallery wall.

This particular approach for a small picture has also been used in the display of fragments of altarpieces on gallery walls. These so-called shadow boxes not only serve as buffers but also enhance the object’s physical presence.

Rothe and Metro state that microclimate boxes should not be too visually overpowering, since their main function is to protect the painting (Rothe and Metro 1985). Rothe and Metro’s Perspex box for the Simone Martini also covered the painting’s original, inseparable frame; the box around the Fayums—which, for obvious reasons, do not have frames—could, of course, only be of a showcase type. Here the objects became, in a sense, archaeological fragments; without the microclimate boxes, the visitor would not have the opportunity to view these fragile objects.

With a microclimate box covering both the painting and the frame, the vitrine does not have to be built to fit the panel painting exactly. Rather, it can be made in standard sizes, allowing reuse for another painting at a later date. Disadvantages include the high reflection factor of Plexiglas and the fact that some viewers find the box aesthetically displeasing.

Ramer, however, suggested that to fulfill aesthetic requirements, the microclimate box around his Netherlandish painting should be fitted into the extended rabbet of the picture frame (Ramer 1984). The box in this case “pretends” not to be present, leaving the viewer’s attention focused on the painting. Most of the more recent constructors of microclimate boxes (i.e., Cassar, Edmunds, Bosshard, Wadum, Sozzani) included these considerations, preferring small, narrow boxes made to fit behind the frame.

The use of low-reflection glass of low iron content (which takes the green out of normal glass) has limited the amount of disturbance to a minimum.

Conclusion

Encapsulating panel paintings in microclimate boxes in this manner reinforces the protection and care of our cultural heritage, benefits that promote an increased willingness by museums to lend their most vulnerable panel paintings.

It would be wrong, however, to suggest that all problems can be overcome by fitting a panel painting in a microclimate box. More secure microclimate boxes with better seals against leakage have yet to be made. Also, the problem of adequate thermal buffers when a painting is on loan has not, in many instances, been satisfactorily handled. The level of shock or vibration to which a paint film and its carrier are exposed during transit still begs further definition: a better solution to this trauma must be found. Correct acclimatization in historic buildings and museums also requires much more research and attention, if the dimensional movement of painted wood that is displayed or stored is to be stabilized.

Acknowledgments

The author is grateful for help and suggestions from Nicola and Nic Costaras and from Feroza Verberne. Special thanks are offered to Aleth Lorne and Victor Wadum for their support during the preparation of this article.

Notes

- 1 Standards for sealed transport cases of wood painted with water-resistant paint, or lined on the inside with a nonpermeable water-resistant membrane, are given by Stolow (1965). The standards include precise volumes for wood and silica gel in the cases.
For maximum thermal insulation, a case should have thick walls, high thermal capacity, small thermal conductivity, and small surface area (Stolow 1967). Stolow gives examples from air transit, in which hulls of planes may reach temperatures of -40°C , or in which hulls have no pressure correction, and therefore, at low pressure, air escapes the box. Upon a plane's return to earth, air again enters because of the higher pressure, and this air may be of an undesired climatological condition. Therefore, cabin-pressure control and temperature control during air transit are important factors to take into account.
- 2 Buck concludes that while good moisture barriers may almost completely insulate a panel from short-cycle humidity variations, they may nonetheless be surprisingly ineffective against seasonal cycles. For recent studies on moisture buffers applied on panel paintings, see Brewer 1991.
- 3 Buck suggests that the larger fluctuations in RH in the United States could be the reason for a tendency to cradle panels more often in the United States than elsewhere (Buck 1962). He further demonstrates that a cradled test panel that was kept in a heated, dry room for several months showed shrinkage of roughly 1.4% in its width, with the members of the cradle sticking out at the sides. Buck invites rheologists to communicate with restorers to learn about the laws that govern the flow and deformation of materials.
- 4 The addition of hygroscopic material (having the same quick response as gelatin) at the rear of the canvas and the sealing of the reverse by a loose lining would help reduce the rate of response of the glue. Glazing with acrylic and a backboard creates further enclosure for the original object and thus provides protection from unwanted reactions to temperature changes (see Hackney 1990).
- 5 Investigation of thermal properties of transport cases is important when traveling exhibitions are on the move. During travel, the cases may be exposed to unforeseen temperature conditions, and the use of thermal linings can offer significant protection and permit greater RH stability within the cases (Stolow 1966).
It is also possible to maintain constant moisture content of soft-packed paintings by controlling temperature, provided that the moisture barrier used as a wrapping material (polyethylene) is well sealed (Saunders, Sitwell, and Staniforth 1991).
An early example of polyethylene as a tight wrap for paintings coming from Europe to Canada is recorded by Thomson (1961).

6 When wood and other moisture-containing materials are heated, they give off moisture. At the same time, heated air can hold more moisture; so together the wood and the air reach a new equilibrium. In an empty case of nonabsorbent material such as glass or metal, a rise in temperature will cause a fall of RH, and vice versa. In a case holding a quantity of wood, the situation is reversed: a rise in temperature will cause a rise in RH. When wood gets hotter, it will give up moisture unless the surrounding RH rises. In a closed case, the RH will indeed rise because of the moisture given off by the wood, and the two tendencies will counteract each other. At median humidity, wood contains about twelve times as much moisture as air, volume for volume. Therefore, wood or other cellulosic materials will have the dominant effect on the interior of a small microclimate box.

Thomson showed in practical experiments that a ratio of 120 g wood per 100 l air achieves a constant RH at changing temperatures (Thomson 1964). The change of RH will not exceed about one-third of the temperature change ($^{\circ}\text{C}$) and will be in the same direction—provided that there is no entry of outside air of a different RH into the case. For ratios greater than 1 kg of wood to 100 l of air, the standard curves for wood equilibrium may be used.

7 Based on the rather dramatic climatological changes occurring in Canada, Stolow demonstrates his findings on different forms of small environments within packing cases (Stolow 1967). It is seen that a sealed case is capable of maintaining a certain level of RH when it contains wood or similar cellulosic materials preconditioned to the desired level. The use of silica gel permits exposure to even greater external temperature changes while it retains the same RH control.

8 The diffusion coefficient of water vapor through air is about $0.24 \text{ cm}^2 \text{ sec}^{-1}$ (Padfield 1966). This is about twice the coefficient of the other gases found in air. The coefficient for diffusion through wood is about $1.2 \times 10^{-4} \text{ cm}^2/\text{sec}$ for water vapor, and $0.75 \times 10^{-4} \text{ cm}^2/\text{sec}$ for carbon dioxide (see Stamm 1964). This means that 1 m^2 of wood allows as much air to diffuse as 3 cm^2 of hole through it, and it leaks water vapor as fast as a 5 cm^2 hole.

9 Weintraub introduces a number of tools for determining which sorbents will be most efficient within a specific RH range (Weintraub 1981). In the 1978 International Council of Museums Conference on Climatology in Museums, there was a general consensus that a sorbent should be temperature independent and have as large a surface area as possible (e.g., powdered silica gel).

10 As a consequence of the many different types of microclimate vitrines being introduced by various authors, Cassar proposed standardization of symbols to be used in classifying the more commonly used types of case construction designs (Cassar 1984).

11 Many woods (especially British and European oak) give off organic acid vapors, which can accumulate and harm many types of objects, including those of metal, marble, materials such as mother-of-pearl and shell, and paper and textiles, in cases where the exchange of air between inside and outside has been reduced to a minimum. All adhesives, adhesive tapes, and sealants used should be tested for stability to ensure that none give off harmful vapors.

12 The choice of the right sorbent is essential and should be considered together with the RH level required for the specific object. Therefore, it is essential to consider the isotherms for the different kinds of sorbents before a decision is made.

13 The RH-control module designed to service a number of display cases is based on a mechanical system combined with a buffering agent such as silica gel (Lafontaine and Michalski 1984). A plastic tubing system distributes the well-conditioned air to a number of display cases, relying on an air exchange in the display cases of a certain amount per day. Air in the display cases equipped with this humidity-control module should be supplied at a rate of at least double the natural leakage. One RH-control module can thus control many display cases. The conditioned air enters the cases through the tubes and leaves again via natural openings that permit leakage. There is no active temperature control—the module passively follows the room temperature. The system, therefore, works only if none of the cases is cooler than the control module.

14 The salts used were hepta- and hexahydrates of zinc sulfate, which are at equilibrium in an atmosphere of 55% RH at a temperature of $15 \text{ }^{\circ}\text{C}$ (Curister 1936).

15 Stolow gives as an example a case for which the wood and silica gel are both 1000 g and the RH is kept stable (Stolow 1967). Even a smaller ratio of gel to wood would have a stabilizing effect, buffering the internal RH against temperature changes. If silica gel is used, it should be packed in a way that gives it as large a surface area as possible.

- 16 The change of RH is somewhat more than a third of the imposed temperature change, and in the same direction as the change (e.g., if the initial RH were 50%, the temperature 20 °C, and the case exposed to 30 °C, the resulting RH would be 53.5% RH; if the case were exposed to a temperature of 10 °C, the final RH would then go to 46.5%).
- 17 Stolow recommends a silica gel granola, not exceeding 3 mm, spread out thinly over as large a surface as possible. He also advises the use of a dry weight of silica gel at least double the weight of the material to be protected (Stolow 1966). In the box discussed, 450 g of silica gel was used.
- 18 The *M* value is the "specific moisture reservoir" (moisture gain in g/kg for a 1% rise in RH).
- 19 Theoretical and experimental research at the Canadian Conservation Institute has shown that if gaps at the top and bottom seams of a case are smaller than 0.3 mm, the leakage rate of the case will be less than two air changes per day (Michalski 1985).
- 20 Previously the panel underwent conservation treatment as follows: The reverse was covered with Saran F-300 (a copolymer of vinylidene and acrylonitrile, soluble in methyl ethyl ketone) and a layer of glass fabric, in an effort to stabilize the panel. Prior to this treatment, it was noted that there was a dark, water-soluble layer (skin-glue sizing perhaps) between the paint film and the wooden support. Four other Fayum portraits (two painted in encaustic, two in a water-soluble medium) were examined, and it was concluded that the intermediate layer between paint and wood was indeed very hygroscopic. The Saran and glass fabric on the reverse side of the Fayum on loan may have altered the warpage pattern, as the panel developed a pronounced concave configuration.
- 21 The museum display cases used in the Sainsbury Centre and their exchange of water vapors are being evaluated. The hygrometric half-time is calculated, as is the half-life for water diffusion in the cases. The better sealed the case, the longer the half-life (Brimblecombe and Ramer 1983).
- 22 A large amount of nitrogen was passed into the case, via the screw hole where the Perspex top was secured. Increasing the concentration of nitrogen acted to deplete the oxygen level to approximately half its normal value. Immediately after the introduction of the nitrogen, a small volume of carbon dioxide was added, which increased the carbon dioxide level of the air in the case to about ten times its normal value. The following day, small samples of gas were extracted and injected into a gas-liquid chromatograph in order that the oxygen and carbon dioxide content might be determined. In this way the gradual loss of carbon dioxide and the invasion of oxygen could be monitored. The half-lives for the exchange of oxygen and carbon dioxide gases with the display case were calculated to be 2.3 and 2.7 days, respectively.
- 23 The case was designed in collaboration with Helmuth Guenschel, Inc., Baltimore, which actually built the case.
- 24 Ranacher's concept was based on the microclimate boxes from the Philadelphia Museum of Art (Ranacher 1988).
- 25 This box was made by the California company of G. F. Wight Conservation, following the principle laid out by Bosshard and Richard.
- 26 This result is explained by the specific characteristics of Art-Sorb, which according to Bosshard desorbs or absorbs different amounts of humidity depending on temperature. However, contradictory reports by several authors as to the nature of the silica gel or Art-Sorb emphasize its stability despite changes in temperature (Richard 1991).
- Richard tested two vitrines of different size: one with an RH of 50%, the other with an RH of 30%. After three months the RH in the small vitrine had decreased to 1%, the large vitrine to only 0.5%. This result proves that the half-time will be around two years for the less sealed of the two. Both tests were made in empty vitrines. It is concluded that the climate would have been even better with the panel inside, as the hygroscopic material would help stabilize the microenvironment. During transit the same benefit was recorded: 16 °C fluctuations in the vehicle but only 2 °C fluctuations in the box. RH fluctuations of 45% were recorded in the vehicle, but only 1% were recorded in the box, as it was kept in a well-insulated transport crate.
- 27 The box was made as a joint project with the Museum Boymans-van Beuningen, Rotterdam, which had the skilled technical staff required for its production. Nicola Costaras, Luuk Struik

- van der Loeff, and Carol Pottasch all contributed to creating this first box, which was designed by André van Lier (Wadum 1992).
- 28 The safety glass used for the first model was Noviflex; at present the thinner and less-costly Mirogard Protect Magic, Low-Iron, is used.
- 29 A method later found not advisable (Wadum 1993).
- 30 ACR data loggers from ACR Systems, Inc., were used. They were typically set at measuring intervals of 30 seconds during transit and at 10 minutes throughout the duration of the loan.
- 31 See note 25 above.
- 32 The Peltier effect describes the absorption or emission of heat when an electric current passes across the junction of two dissimilar conductors.
- 33 The microclimate boxes were initially made by Smit Mobile Equipment B.V., Oud-Beijerland, the Netherlands; they are now produced by the technical staff of the museum, according to the most recent manual.
- 34 The author is indebted to Susannah Edmunds at the Victoria and Albert Museum for information on this early microclimate box.
- 35 Pastorelli and Rapkin Ltd., London, was taken over in 1983 by M and T Precision Instruments Ltd., Enfield.
- 36 The Humidical Corp. type card no. 6203-BB seemed to satisfy most users.
- 37 The author is indebted to Sarah Fisher, National Gallery of Art, Washington, D.C., for sharing her information on measuring devices.
- 38 Shock monitoring may also constitute part of the recording of a painting in transit. The most recent literature on this topic can be found in Mecklenburg 1991, in which several authors deal with the subject. The author has had fruitful discussions on this topic with David Saunders of the National Gallery, London.
- 39 The logging interval during transit would often be 30 seconds; the interval during exhibition would generally be 10 minutes.
- 40 With regard to the investigation into the performance of humidity sensors, M. Cassar is conducting a comparison of ten different sensors for stability, drift, and long-term performance. This work in progress will provide valuable information for the assessment of measurements obtained by study of artifacts on display or in transit.

Materials and Suppliers

ACR data loggers, ACR Systems Inc., 8561 - 133rd Street, Surrey, British Columbia, Canada V3W 4N8.

Ageless, Ageless Z, Ageless Z-200, Ageless-Eye, Mitsubishi Gas Chemical Co., Mitsubishi Building, 5-2 Marunouchi 2-chome, Chiyoda-ku, Tokyo, 110 Japan. (Different types of Ageless are available depending upon the water activity (WA) of the packaged commodity: AgelessZ WA \leq 0.85%, Ageless A-200 indicates that 200 ml of oxygen can be absorbed. Ageless-Eye is used as a color-changing oxygen indicator.)

Art-Sorb, Fuji Silysia Chemical Ltd., 6th Floor, YH Hisaya Building, 13-35, 1-Chome, Izumi, Higashi-Ku, Nagoya-Shi, Aichi-Ken, 461 Japan.

Edney dial hygrometer, Edney 2 in dial hygrometer (ref. PH2P), M and T Precision Instruments Ltd., Queensway, Enfield, Middlesex EN3 4SG, U.K.

Grant Squirrel Data Loggers, Grant Instruments Ltd., Barrington, Cambridge CB2 5QZ, U.K.

Humidical Corp. type card no. 6203-BB, Humidical Corp., 465 Mt. Vernon Avenue, P.O. Box 464, Colton, CA 92324.

Kaken Gel, Kaken Pharmaceutical Co. Ltd., 2-28-8 Honkomagome, Bunkyo-ku, Tokyo, Japan.

Lexan, General Electric Plastics, Old Hall Road, Cheshire M33 2HG, U.K.

Mirogard Protect Magic, Low-Iron, Deutsche Spezialglas AG, (DESAG/Schott), Postfach 2032, 31074 Grünenplan, Germany.

Nikka pellets, Nippon Kasseihakudo Co. Ltd. (Nippon Activated Clay Co. Ltd.), 7th Floor, Daisan-Azuma Bldg., 1, Kandahirakawacho, Chiyoda-ku, Tokyo, 110 Japan.

Saran F-300, Dow Plastics, 2020 Willard Dow Center, Midland, MI 48674.

Squirrel, Eltek Ltd., 35 Barton Road, Haslingfield, Cambridge CB3 7LL, U.K.

References

- Ashley-Smith, J., and A. J. Moncrieff
1984 Experience with silica gel for controlling humidity in showcases. In *ICOM Committee for Conservation 7th Triennial Meeting, Copenhagen, 10–14 September 1984, Preprints*, vol. 2, ed. Diana de Froment, 84.17.1–5. Paris: ICOM Committee for Conservation.
- Bosshard, E.
1990 Klimavitrinen für Gemälde, Eine wirksame und ästhetisch befriedigende Methode. *Restaurio* 3:176–80.
- Bosshard, E., and M. Richard
1989 Climatized vitrines for paintings: An uncomplicated but efficient method. In *American Institute for Conservation: Annual Meeting Preprints, Cincinnati*. Washington, D.C.: AIC.
- Brewer, J. A.
1991 Effect of selected coatings on moisture sorption of selected wood test panels with regard to common panel painting supports. *Studies in Conservation* 36:9–23.
- Brimblecombe, P., and B. Ramer
1983 Museum display cases and the exchange of water vapors. *Studies in Conservation* 28:179–88.
- Brown, J. P.
1994 Hygrometric measurement in museums: Calibration, accuracy, and the specification of relative humidity. In *Preprints of the Contributions to the Ottawa Congress, 12–16 September 1994: Preventive Conservation—Practice, Theory and Research*, ed. Ashok Roy and Perry Smith, 39–43. London: IIC.
- Buck, R. D.
1952 A note on the effect of age on the hygroscopic behavior of wood. *Studies in Conservation* 1:39–44.
- 1961 The use of moisture barriers on panel paintings. *Studies in Conservation* 6:9–19.
- 1962 Is cradling the answer? *Studies in Conservation* 7:71–74.
- 1972 Some applications of rheology to the treatment of panel paintings. *Studies in Conservation* 17:1–11.
- 1979 *The Behavior of Wood and the Treatment of Panel Paintings: The 7th International Congress of the International Institute for Conservation of Historic and Artistic Works, Wood in Painting and the Decorative Arts, Oxford Congress 1978*. Minneapolis: Upper Midwest Conservation Association.
- Byrne, R. O.
1984 An Easter Island effigy figure display case. In *ICOM Committee for Conservation 7th Triennial Meeting, Copenhagen, 10–14 September 1984, Preprints*, vol. 2, ed. Diana de Froment, 84.17.9–10. Paris: ICOM Committee for Conservation.

- Cassar, M.
1984 Proposal for a typology of display case construction designs and museum climate control systems. In *ICOM Committee for Conservation 7th Triennial Meeting, Copenhagen, 10–14 September 1984, Preprints*, vol. 2, ed. Diana de Froment, 84.17.11–15. Paris: ICOM Committee for Conservation.
- 1985 Checklist for the establishment of a microclimate. *The Conservator* 9:14–16.
- 1988 A microclimate within a frame for a portrait hung in a public place. In *United Kingdom Institute for Conservation 30th Anniversary Conference Preprints*, comp. Victoria Todd, 46–49. London: United Kingdom Institute for Conservation.
- Cassar, M., and G. Martin
1994 The environmental performance of museum display cases. In *Preprints of the Contributions to the Ottawa Congress, 12–16 September 1994: Preventive Conservation—Practice, Theory and Research*, ed. Ashok Roy and Perry Smith, 171–73. London: IIC.
- Constable, W. G.
1934 Framing and the control of humidity. Appendix 3 of *Some Notes on Atmospheric Humidity in Relation to Works of Art*, 48. London: Courtauld Institute of Art.
- Curister, S.
1936 Control of air in cases and frames. *Technical Studies in the Field of the Fine Arts* 6:109–16.
- Daniels, V. D., and S. E. Wilthew
1983 An investigation into the use of cobalt salt impregnated papers for the measurement of relative humidity. *Studies in Conservation* 28:80–84.
- de Guichen, G., and C. Kabaoglu
1985 How to make a rotten show-case. *Museum* 37(2):64–67.
- Diamond, M.
1974 A micro-micro-climate. *Museums Journal* 4:161–63.
- Edmunds, S.
1988 A microclimate box for a panel painting fitted within the frame. In *United Kingdom Institute for Conservation 30th Anniversary Conference Preprints*, comp. Victoria Todd, 50–53. London: United Kingdom Institute for Conservation.
- Erhard, D., and M. Mecklenburg
1994 Relative humidity re-examined. In *Preprints of the Contributions to the Ottawa Congress, 12–16 September 1994: Preventive Conservation—Practice, Theory and Research*, ed. Ashok Roy and Perry Smith, 32–38. London: IIC.
- Feller, R. L.
1969 Transportation of a panel painting by courier in winter. In *Papers Given at the Annual Meeting of IIC-American Group*, 13–14. Los Angeles: IIC, American Group.
- Gilberg, M.
1990 Inert atmosphere disinfestation using Ageless oxygen scavenger. In *ICOM Committee for Conservation 9th Triennial Meeting, Dresden, German Democratic Republic, 26–31 August 1990, Preprints*, vol. 2, ed. Kirsten Grimstad, 812–16. Los Angeles: ICOM Committee for Conservation.
- Gilberg, M., and D. W. Grattan
1994 Oxygen-free storage using Ageless oxygen absorber. In *Preprints of the Contributions to the Ottawa Congress, 12–16 September 1994: Preventive Conservation—Practice, Theory and Research*, ed. Ashok Roy and Perry Smith, 177–80. London: IIC.

- Hackney, S.**
1987 The dimensional stability of paintings in transit. In *ICOM Committee for Conservation 8th Triennial Meeting, Sydney, Australia, 6–11 September 1987, Preprints*, 597–600. Marina del Rey, Calif.: Getty Conservation Institute.
- 1990 Framing for conservation at the Tate Gallery. *The Conservator* 14:44–52.
- Kamba, N.**
1993 Measurement of the dimensional change of wood in a closed case. In *ICOM Committee for Conservation 10th Triennial Meeting, Washington, D.C., U.S.A., 22–27 August 1993, Preprints*, vol. 1, ed. Janet Bridgland, 406–9. Paris: ICOM Committee for Conservation.
- Kenjo, T., and K. Toishi**
1975 Purification of air with zeolite. *Science for Conservation* 12:27–31.
- Klein, P., and F. W. Bröker**
1990 Investigation on swelling and shrinkage of panels with wooden supports. In *ICOM Committee for Conservation 9th Triennial Meeting, Dresden, German Democratic Republic, 26–31 August 1990, Preprints*, vol. 1, ed. Kirsten Grimstad, 41–45. Los Angeles: ICOM Committee for Conservation.
- Knight, P.**
1983 An enclosure for the Tate panels in the Church of All Hallows Berkyngeschirche by the Tower. *Conservator* 7:34–36.
- Lafontaine, R. H., and S. Michalski**
1984 The control of relative humidity: Recent developments. In *ICOM Committee for Conservation 7th Triennial Meeting, Copenhagen, 10–14 September 1984, Preprints*, vol. 2, ed. Diana de Froment, 84.17.33–37. Paris: ICOM Committee for Conservation.
- Lambert, F. L., V. Daniel, and F. D. Preusser**
1992 The rate of absorption of oxygen by Ageless: The utility of an oxygen scavenger in sealed cases. *Studies in Conservation* 37:267–74.
- MacIntyre, J.**
1934 Air conditioning for Mantegna's cartoons at Hampton Court Palace. *Technical Studies in the Field of Fine Arts* 2(4):171–84.
- Mayer, M.**
1988 Erfassung des Vitrinenklimas. In *Mitteilungen des Österreichischen Restauratorenverbandes*, 51–56. Vienna: Österreichischer Restauratorenverband.
- Mecklenburg, M. F., ed.**
1991 *Art in Transit: Studies in the Transport of Paintings*. Washington, D.C.: National Gallery of Art.
- Mecklenburg, M. F., and C. S. Tumosa**
1991 Mechanical behavior of paintings subjected to changes in temperature and relative humidity. In *Art in Transit: Studies in the Transport of Paintings*, ed. M. F. Mecklenburg, 173–216. Washington D.C.: National Gallery of Art.
- Michalski, S.**
1985 A relative humidity control module. *Museum* 37(2):85–88.
- 1991 Paintings: Their response to temperature, relative humidity, shock, and vibration. In *Art in Transit: Studies in the Transport of Paintings*, ed. M. F. Mecklenburg, 223–48. Washington D.C.: National Gallery of Art.

- Miura, S.**
1981 Studies on the behaviour of RH within an exhibition case. Part II: The static and dynamic characteristics of sorbents to control the RH of a show-case. In *ICOM Committee for Conservation 6th Triennial Meeting, Ottawa, 21–25 September 1981, Preprints*, 81.18.5.1–10. Paris: ICOM Committee for Conservation.
- Padfield, T.**
1966 The control of relative humidity and air pollution in show-cases and picture frames. *Studies in Conservation* 1:8–30.
- Padfield, T., T. Burke, and D. Erhard**
1984 A cooled display case for George Washington's Commission. In *ICOM Committee for Conservation 7th Triennial Meeting, Copenhagen, 10–14 September 1984, Preprints*, vol. 2, ed. Diana de Froment, 84.17.38–42. Paris: ICOM Committee for Conservation.
- Padfield, T., D. Erhard, and W. Hopwood**
1982 Trouble in store. In *Science and Technology in the Service of Conservation: Preprints to the Washington IIC Congress, 3–9 September 1982*, ed. N. S. Bromelle and G. Thomson, 24–27. London: IIC.
- Phillimore, E. A., ed.**
1979 *In Search of the Black Box: A Report on Proceedings of a Workshop on Micro-Climates Held at the Royal Ontario Museum, February 1978*. Toronto: Royal Ontario Museum.
- Ramer, B. L.**
1981 Stabilizing relative humidity variation within display cases: The role of silica gel and case design. In *ICOM Committee for Conservation 6th Triennial Meeting, Ottawa, 21–25 September 1981, Preprints*, 81.18.6.1–12. Paris: ICOM Committee for Conservation.
- 1984 The design and construction of two humidity-controlled display cases. In *ICOM Committee for Conservation 7th Triennial Meeting, Copenhagen, 10–14 September 1984, Preprints*, vol. 2, ed. Diana de Froment, 84.17.46–49. Paris: ICOM Committee for Conservation.
- 1985 Show-cases modified for climate control. *Museum* 37(2):91–94.
- Ranacher, M.**
1988 Zum Bau von Klimavitrinen mit direkter elektronischer Messung. In *Mitteilungen des Österreichischen Restauratorenverbandes*, 41–49. Vienna: Österreichischer Restauratorenverband.
- 1994 The cold wall problem as a cause of accelerated aging of paintings. Poster presented at International Institute for the Conservation of Historic and Artistic Works (IIC) Ottawa Congress, 12–16 September 1994.
- Richard, M.**
1991 Control of temperature and relative humidity in packing cases. In *Art in Transit: Studies in the Transport of Paintings*, ed. M. F. Mecklenburg, 279–97. Washington, D.C.: National Gallery of Art.
- 1993 Conversation with the author. Conservation Laboratory, National Gallery of Art, Washington, D.C.
- 1994 The transport of paintings in microclimate display cases. In *Preprints of the Contributions to the Ottawa Congress, 12–16 September 1994: Preventive Conservation—Practice, Theory and Research*, ed. Ashok Roy and Perry Smith, 185–89. London: IIC.
- Rothe, A., and B. Metro**
1985 Climate controlled show-cases for paintings. *Museum* 37(2):89–91.

- Sack, S. P.
1963–64 A case study of humidity control. *Brooklyn Museum Annual* 5:99–103.
- Sack, S. P., and N. Stolow
1978 A micro-climate for a Fayum painting. *Studies in Conservation* 23:47–56.
- Saunders, D., and T. Reeve
1993 Protective glass for paintings. *National Gallery Technical Bulletin* 15:98–103.
- Saunders, D., C. L. Sitwell, and S. Staniforth
1991 Soft pack: The soft option. In *Art in Transit: Studies in the Transport of Paintings*, ed. M. F. Mecklenburg, 311–21. Washington, D.C.: National Gallery of Art.
- Schweizer, F.
1984 Stabilization of RH in exhibition cases: An experimental approach. In *ICOM Committee for Conservation 7th Triennial Meeting, Copenhagen, 10–14 September 1984, Preprints*, vol. 2, ed. Diana de Froment, 84.17.50–53. Paris: ICOM Committee for Conservation.
- Schweizer, F., and A. Rinuy
1980 Zur Mikroklimalisierung zweier Vitrinen mit Ikonen für eine temporäre Ausstellung. *Maltechnik-Restaur* 4:239–43.
- Shashoua, Y., and S. Thomson
1991 A field trial for the use of Ageless in the preservation of rubber in museum collections. In *Canadian Conservation Institute Symposium '91, Saving the Twentieth Century: The Degradation and Conservation of Modern Materials, Abstracts*, 14. Ottawa: Canadian Conservation Institute.
- Simpson, W. S.
1893 *An Improved Method of Means of Preserving Oil Paintings, Water Colour Drawings, Engravings, Photographs, Prints, and Printed Matter from Atmospheric Deterioration and from Decay*. London: Her Majesty's Stationery Office.
- Sozzani, L.
1992 Climate vitrine for paintings using the picture's frame as primary housing. Report, Conservation Department, Rijksmuseum, Amsterdam.
- Stamm, A. J.
1964 *Wood and Cellulose Science*. New York: Roland Press.
- Stevens, W. C.
1961 Rates of change in the dimensions and moisture contents of wooden panels resulting from changes in the ambient air conditions. *Studies in Conservation* 1:21–24.
- Stolow, N.
1965 Report on controlled environment for works of art in transit. Joint meeting of the ICOM committee for Scientific Museum Laboratories and the ICOM sub-committee for the Care of Paintings, Washington and New York. Typescript.
- 1966 Fundamental case design for humidity sensitive museum collections. *Museum News* (Washington, D.C.) 44(6):45–52.
- 1967 Standards for the care of works of art in transit. Report, International Institute for the Conservation of Historic and Artistic Works London Conference on Museum Climatology. Typescript.
- 1977 The microclimate: A localized solution. *Museum News* (Washington, D.C.) 56:52–63.
- 1981 Controlled climate cases for works of art: Installation and monitoring. In *ICOM Committee for Conservation 6th Triennial Meeting, Ottawa, 21–25 September 1981, Preprints*, 81.18.8.1–4. Paris: ICOM Committee for Conservation.

- Thomson, G.**
 1961 Museum climate: Humidity control, packing and transport. *Studies in Conservation* 6:110–11.
- 1964 Relative humidity: Variation with temperature in a case containing wood. *Studies in Conservation* 9:153–69.
- 1977 Stabilization of RH in exhibition cases: Hygrometric half-time. *Studies in Conservation* 22:85–102.
- 1981 Control of the environment for good or ill? Monitoring. *National Gallery Technical Bulletin* 5:3–13.
- Toishi, K.**
 1961 Relative humidity in a closed package. *Studies in Conservation* 6:111–12.
- Toishi, K., and S. Miura**
 1977 Purification of air with zeolite. *Science for Conservation* 14:1–7.
- Toshiko, K.**
 1980 Studies on long-term conservation of cultural properties: The effect of different concentration of oxygen on pigments used for cultural properties. *Scientific Papers on Japanese Antiques and Art Crafts* 15:103–7.
- Wadum, J.**
 1992 De betere klimaatdoos. *Het Mauritshuis Nieuwsbrief* 2:8–9.
- 1993 Microclimate-boxes revisited. Talk given at the ICOM-CC meeting of the Working Group on the Care of Works of Art in Transit, August, 1993, Washington, D.C.
- Wadum, J., I. J. Hummelen, W. Kragt, B. A. H. G. Jütte, and L. Sozzani**
 1994 Research programme microclimates: Paintings on panel and canvas. Poster presented at International Institute for the Conservation of Historic and Artistic Works (IIC) Ottawa Congress, 12–16 September 1994.
- Weintraub, S.**
 1981 Studies on the behavior of RH within an exhibition case. Part I: Measuring the effectiveness of sorbents for use in an enclosed showcase. In *ICOM Committee for Conservation 6th Triennial Meeting, Ottawa, 21–25 September 1981, Preprints*, 81.18.4.1–11. Paris: ICOM Committee for Conservation.
- 1982 A new silica gel and recommendations. In *American Institute for Conservation of Historic and Artistic Works: Preprints of Papers Presented at the 10th Annual Meeting, Milwaukee, Wisconsin, 26–30 May 1982*, 169–73. Washington, D.C.: AIC.
- Wilson, B. H., and L. W. Barridge**
 1933 *Improvement in Controlling the Humidity of Air in Enclosed Spaces Such as Containers, Picture Frames, and Rooms*. London: Her Majesty's Stationery Office.

Technical Considerations for the Transport of Panel Paintings

Mervin Richard, Marion Mecklenburg, and Charles S. Tumosa

OVER THE YEARS, panel paintings have suffered damage from a wide range of causes—accidents, natural catastrophes, improper handling, dramatic environmental changes, and misguided conservation treatments. Once damaged, panel paintings can be difficult to repair. Due to this risk, many museum professionals and collectors are hesitant to transport panels unless absolutely necessary. Some institutions have even adopted policies that forbid their loan. In the United States, panel paintings are not indemnified by the Arts and Artifacts Indemnity program, a government program that provides insurance for international exhibitions designated as being in the national interest.

Indeed, some paintings on wood supports are very fragile and should not be transported or loaned to other institutions. Even the most ideal packing case cannot protect a painting in very poor condition. Many panel paintings are very stable, however, and can be safely packed and transported.

A thorough technical examination of panel paintings considered for loan is probably the most crucial aspect of the loan process. This examination is especially useful if condition and treatment records have been maintained for many years. Paintings that have recurring problems such as flaking paint are poor candidates for loans, unless the cause of the insecurity of the paint is clearly understood and controllable.

There are four environmental conditions that should be considered when evaluating any painting for possible loan: relative humidity (RH), temperature, shock, and vibration. The overall safety of a painting during transit is gauged by any expected response to these conditions; this response must then be evaluated in terms of what the painting will be able to withstand and what protection the proposed transport is able to provide. For example, a very fragile painting might suffer impact poorly, and no packing condition would be able to provide the protection needed to ensure safe transport. If this is the particular case, transport of the painting is not recommended. However, if the painting can sustain moderate fluctuations in RH and temperature (factors easily controlled during transport), and the panel can safely resist the anticipated levels of shock and vibration, then the panel is a more likely candidate for loan.

There are several things to consider about the painting itself when contemplating a possible loan, including the following: the size of the painting, its materials and construction, the condition of the design (paint and ground) layers, and the condition of the wood supports. Small

paintings usually present fewer difficulties than large paintings, since they are lightweight, easily moved, and frequently made of a single piece of wood. Large panels are heavier and more subject to bending moments during handling operations, because of their own weight and width. Bending or flexing can also result from impact and vibration, which will increase the stress throughout the panel and have particularly adverse effects on poorly glued joints and existing cracks in the wood.

Considerable anecdotal evidence shows that some panels have been exposed to extensive environmental fluctuations for years without apparent damage, while others subjected to similar conditions have suffered. Some paintings have remained stable for centuries, probably only because their environment has also remained relatively stable. If subjected to a different environment, the same paintings might rapidly develop problems.

Until recently, the only way to verify and observe this effect was to change the environment to see what occurs. Obviously, this test can prove destructive: damage has been reported when paintings have been moved from relatively damp churches to drier and better-controlled environments in museums or private homes. Similar problems also have developed when central heating systems without humidification have been installed in buildings that were normally cold and damp. These reports have led institutions to become cautious when considering the advisability of lending a panel painting. Lenders to exhibitions frequently require that borrowers maintain environmental RH levels closely matching the conditions where their paintings are exhibited.

Battens or cradles have often been added to the reverse of panels, either to reinforce the panels or to reduce warping. Usually such restoration treatments have limited success and often lead to additional problems, since these devices tend to restrain RH- and temperature-related movement in the cross-grain direction of the panel. This restraint can lead to excessive stresses (either compressive or tensile) if the RH or temperature significantly deviates from the conditions present when the battens or cradle were applied.

The issue, then, lies in assessing the effects of changes in temperature and RH, as well as the events of impact and vibration on panel paintings, and recognizing the limitations of controlling these factors during transport. The typically short duration of transport usually precludes chemical damage to paintings, but occasionally biological problems, such as mold growth, arise. For the most part, determining the risks inherent to the transport of a panel painting is an engineering problem that requires a knowledge of the mechanics of artists' materials. This particular discipline is an important part of the authors' current research, and a summary of materials' behavior is a significant focus of this article.

RH and Moisture Content

All the materials typically found in panel paintings are hygroscopic; they adsorb water when the RH increases and desorb water when the RH decreases. These materials include the wood supports, hide glues, gesso and paint layers, and varnishes. When these materials are unrestrained, changes in their moisture content result in expansion and contraction. It should be noted that panel materials respond differently to the gain and loss of water vapor. Oil paints and gessos show relatively little dimensional response to moisture, for example, as compared to pure hide glue or to wood cut in the tangential direction. Wood cut in the radial direction

shows about one-half of the dimensional response of wood cut in the tangential direction (U.S. Department of Agriculture 1987). The dimensional response of wood in the parallel-to-grain direction is 0.05–0.08% of that in the tangential direction. In the tangential direction, some woods (e.g., cottonwood [*Populus* spp.] and white oak [*Quercus* spp.]) can swell as much as 7% when subjected to changes from 5% to 95% RH. Other woods (e.g., spruce [*Picea* spp.] and mahogany [*Swietenia macrophylla* sp.]) swell only 3.5% under similar conditions. The rate of dimensional change with respect to RH is usually called the *moisture coefficient of expansion* and is cited in units of strain per percentage RH (mm/mm/% RH). It is of critical importance to recognize that free-swelling dimensional changes are stress-free strains. It is only when under restraint that hygroscopic materials subjected to RH changes develop stress-associated strains. These are called mechanical strains, in the truest sense of the word.

A coefficient of expansion is often considered to be a constant; however, the moisture coefficients for these materials are not only variable but highly nonlinear as well. In Figure 1, the moisture coefficients for four materials are plotted versus RH. These materials are a fifteen-year-old flake white oil paint, gesso with a pigment volume concentration of 81.6%, hide glue, and a sample of white oak in the tangential direction. In this plot, the longitudinal direction of the white oak (or of any wood) would factor almost along the zero line. In Figure 1 all of the materials have very low rates of dimensional response with respect to RH in the 40–60% range. Outside this range the wood and glue show dramatic increases in the rate of dimensional response with respect to RH, and there is a significant deviation of the wood and glue responses in relation to the paint and gesso responses. This mismatch in the coefficients is indicative of the source of most of the problems associated with environmental changes. Wood in the longitudinal direction responds much less to the environment than do the paint and gesso, which essentially means that different responses are occurring to the painting's layers in the two perpendicular directions of the panel. The responses of the materials to RH can be studied either alone or as part of a composite construction.

A material that is allowed to expand and contract freely can be repeatedly subjected to a fairly wide RH range without damage. In addition, woods (e.g., white oak) show a dramatic hysteresis when the unrestrained dimensional response is measured over a very large range of humidity. The increasing RH path tends to stay lower than the decreasing RH path; therefore, if the measurements are taken at 25–75% RH, the increasing and decreasing paths are almost the same.

A structural problem arises when either full or partial restraint is present. This restraint can result from defects such as knots in the wood, cross-grain construction (often found in furniture), or battens that are attached to the reverse of a panel. If battens and cradles restrict the dimensional movement of the wood, stresses and strains develop perpendicular to the grain with changes in RH. Internal restraint can develop when the outer layers of a massive material respond more quickly than the interior layer.

Research has shown that there are reversible levels of stress and strain. In the case of a fully restrained material (white oak in the tangential direction, for example), some changes in RH can occur without ill effect to the wood (Mecklenburg, Tumosa, and Erhardt 1998). Organic materials (i.e., wood, paints, glue, gesso) have *yield points*, which are levels of strain

below full reversibility and above permanent deformation. Measured by an axial mechanical test, the initial yield points for woods, paints, and glues are approximately 0.004. These materials can, however, harden under strain, a process that creates substantial increases in their yield points. For a brittle gesso found in a traditional panel painting, the yield point is approximately 0.0025. If gesses are richer in glue, both their yield points and their strains at failure increase significantly. The magnitudes of yield points do not appear to be appreciably affected by RH, but generally the strains to breaking will increase parallel to increases in RH. Finally, RH- and temperature-related events are biaxial and triaxial events. This means that yielding can occur at significantly higher strain levels than axial testing would indicate. In this article, the lowest axially measured strain level of 0.004 will be used for all materials except gesso, which yields at 0.0025. These yield points will be used to determine the maximum allowable RH fluctuations in panels. This approach is a fairly conservative one to assessing the effects of RH and temperature on panel paintings, and it should be considered accordingly. It also should be noted here that while materials yield at strains of 0.004 or greater between 35% and 65% RH, strains of 0.009 or greater are necessary to cause failure. The strains at failure in seriously degraded materials are often lower because the process of degradation usually reduces strength. When the magnitude of the failure strains approaches that of the yield strains, the materials of the panel painting are considered fragile and probably difficult to handle, as they will break in an elastic region rather than plastically deform.

Response of restrained wood to RH: Tangential direction

Research has shown that the moisture coefficient of a material can be used to calculate the RH change required to induce both yielding and failure strains in a restrained material (Mecklenburg, Tumosa, and McCormick-Goodhart 1995). Equation 1 shows how these mechanical strains can be calculated as a function of RH. Using this equation, the strain change ($\Delta\Sigma$) for any RH change can be calculated by integrating from one RH point to another as

$$\Delta\Sigma = \int \partial \, dRH \quad (1)$$

where: $\partial = d\Sigma/dRH$, the moisture coefficient of expansion.

The yield point for white oak is about 0.004 at all RH levels, and its breaking strains increase with increasing RH. These strain values are shown in Figure 2. The failure strains are small at a low RH and increase dramatically as RH increases.

With the information from Figures 1 and 2 and Equation 1, it is possible to develop a picture of the effects of RH on the strains of white oak fully restrained in the tangential direction. This is a hypothetical example of the worst condition possible; fortunately, few objects in collections are actually fully restrained. The plotted results of calculations made using Equation 1 are shown in Figure 3. In this plot, the calculated results show what would occur if white oak in the tangential direction were restrained at 50% RH, then subjected to RH changes. A decrease to approximately 33% RH would result in tensile yielding of the wood. Further decreasing, to 21% RH, could cause the wood to crack. Increasing the RH from 50% to approximately 64% would cause the wood to begin

Figure 1

Moisture coefficients of expansion versus RH for four materials: white oak in the tangential direction, hide glue, gesso, and fifteen-year-old flake white oil paint. The radial-direction coefficient for white oak is approximately one-half of the tangential, and the longitudinal-direction coefficient is about one-tenth of the tangential. The swelling rate is the lowest in the midrange RH levels.

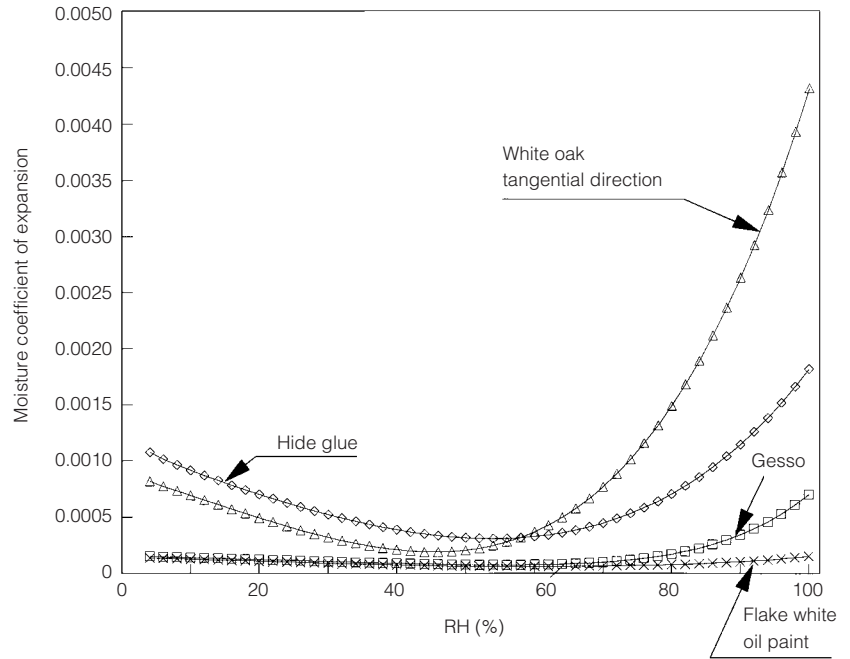
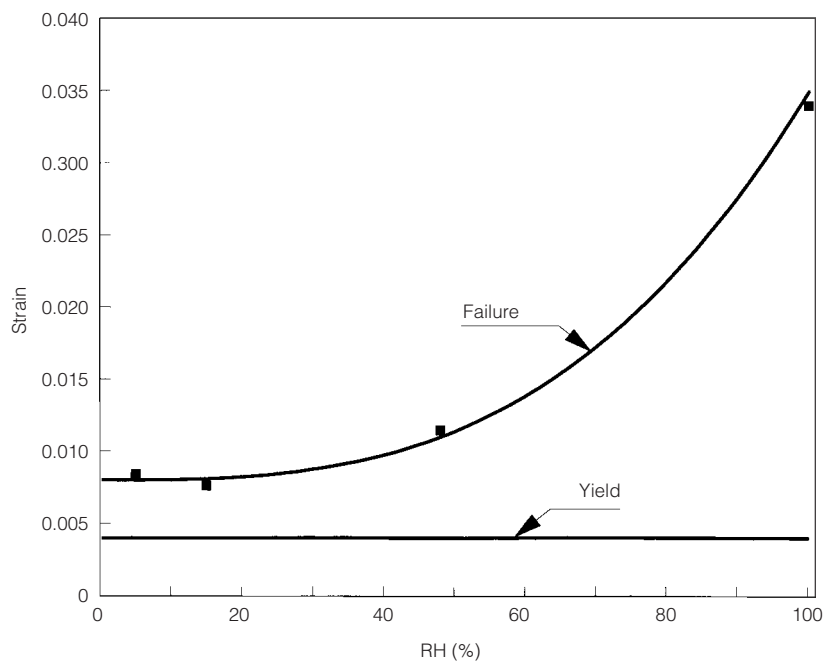

Figure 2

Measured yield and breaking strains of tangential-direction white oak versus RH (axial tensile test).



compression yielding. As long as the RH remains between approximately 33% and 64%, the wood can respond dimensionally without its structure being altered. However, if the RH increases above approximately 64%, *compression set* may occur, which is a permanent deformation of the wood. Compression set also re-initializes the wood to a new, higher RH environment, causing the wood to behave like one acclimated to a higher RH.

The plots in Figure 4 were obtained by recalculating Equation 1 for the fully restrained white oak panel, now acclimated to 70% RH (the circumstances under which the panel acclimated to a higher ambient RH are irrelevant—it does not matter whether the painting has always been maintained at 70% or whether it was temporarily stored in a damp location).

Figure 3

Calculated reversible RH range of fully restrained, tangentially cut white oak versus ambient RH. A yield value of 0.004 was used as the limiting criterion in both tension and compression. The values of the dotted lines are for stress-free wood that has been fully equilibrated to 50% RH.

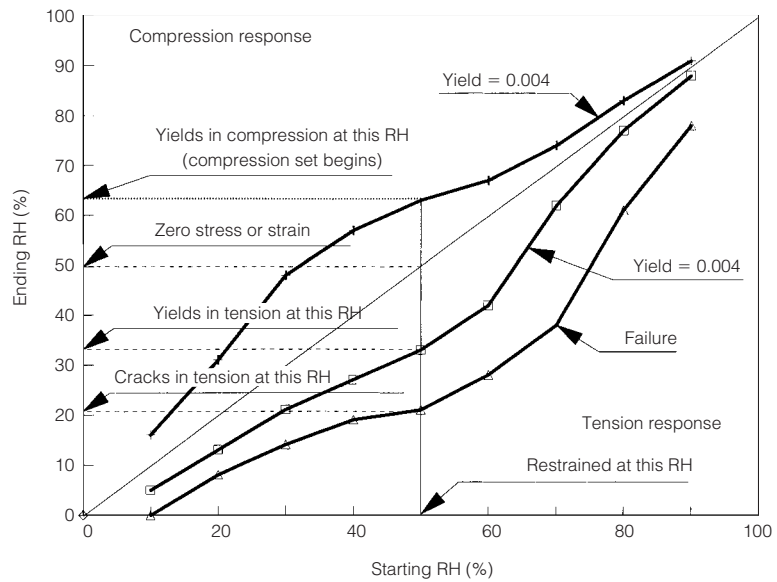
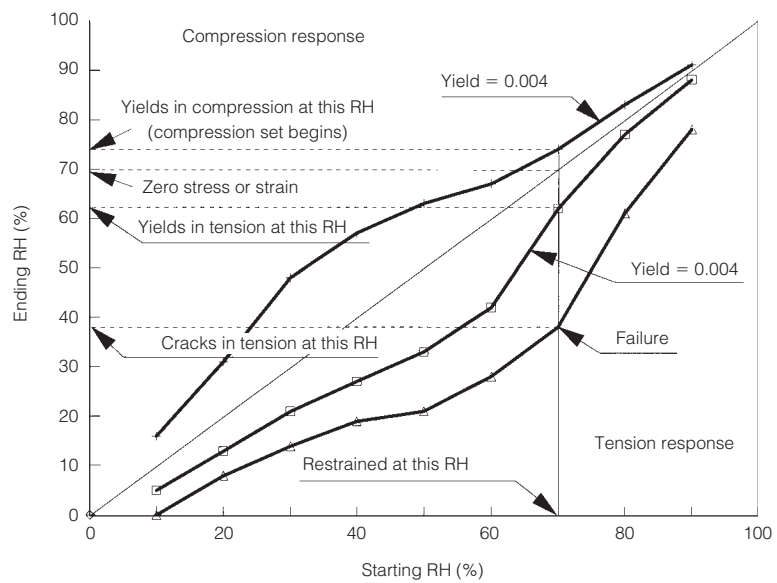

Figure 4

Calculated reversible RH range of fully restrained, tangentially cut white oak versus ambient RH. A yield value of 0.004 was used as the limiting criterion in both tension and compression. The wood has been fully equilibrated to 70% RH. The allowable RH range has been severely reduced in comparison to wood equilibrated to 50% RH.



A problem becomes apparent when desiccation of the panel is attempted. A drop from 70% to 62% RH causes tensile yielding, and a drop to approximately 38% RH can cause cracking of the wood. Increasing the RH to approximately 74% induces yielding in compression. The panel cannot tolerate the much larger variations in RH that are possible with a panel equilibrated to 50% RH, as seen in Figure 3. This narrow range of RH must be considered when evaluating the risks of lending panel paintings acclimated to high RH.

In the past, some panels have been treated with water or large amounts of water vapor in an attempt to flatten them. Battens or cradles

Figure 5

Calculated reversible RH range of fully restrained, tangentially cut white oak versus ambient RH. A yield value of 0.004 was used as the limiting criterion in both tension and compression. The wood has been fully equilibrated to 36% RH. The allowable RH range is still fairly broad, but it has been shifted to lower values.

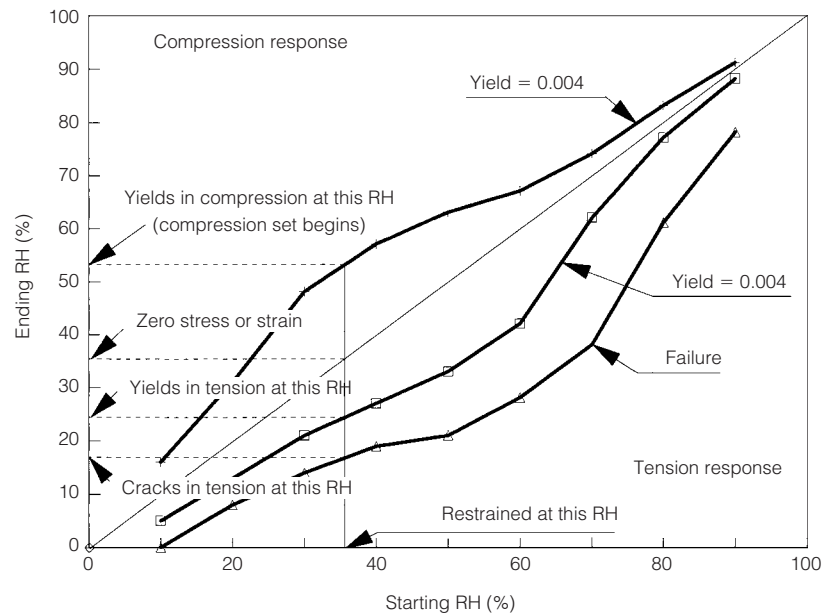

were often attached to the reverse while a panel was still wet. The effect of this treatment was to restrain the panel while it was still acclimated at an extremely high RH. As the panel dries, the adhesive hardens, and the point of full restraint could easily have a moisture content equivalent to acclimation of the wood at 75% RH. If this is the case, this panel will yield in tension at around 68% RH and could quite possibly crack at approximately 45% RH. If a restrained panel were to be subjected to a flood (such as occurred in Florence in 1966), the simple act of drying would be almost certain to cause wood-support damage unless all of the restraint were removed before drying.

Figure 5 shows the results of RH fluctuations on a typical white oak panel restrained and equilibrated at 36% RH. In this case the panel will yield in compression at approximately 53% RH and in tension at 25% RH. The effect is to simply ensure that the reversible environment for the painting support panels is changed to a lower RH.

For comparison purposes, the moisture coefficient of expansion for a 100-year-old white oak sample was measured in the tangential direction. This measurement allows for a comparison of the strain development in new and aged oak. Figure 6 shows that when the same yield criterion (0.004) is used, the 100-year-old oak appears to be able to sustain slightly greater RH variations, particularly at the extreme ranges of the RH spectrum. Many other woods used as painting supports have less dimensional response to moisture than white oak, so their allowable fluctuations will be significantly greater, even in the tangential grain direction.

Response of restrained wood to RH: Radial direction

The moisture coefficient of expansion in the radial direction is about one-half that of the tangential direction. If a wood panel support is made so that the two primary directions of the wood are longitudinal and radial, the panel can sustain significantly greater variations in humidity than if a primary direction were tangential. Figure 7 shows a comparison of the

Figure 6

Calculated reversible RH range of fully restrained, new, tangentially cut white oak versus ambient RH, compared to 100-year-old oak. A yield value of 0.004 was used as the limiting criterion in both tension and compression. It is assumed that the wood has been fully equilibrated to 50% RH.

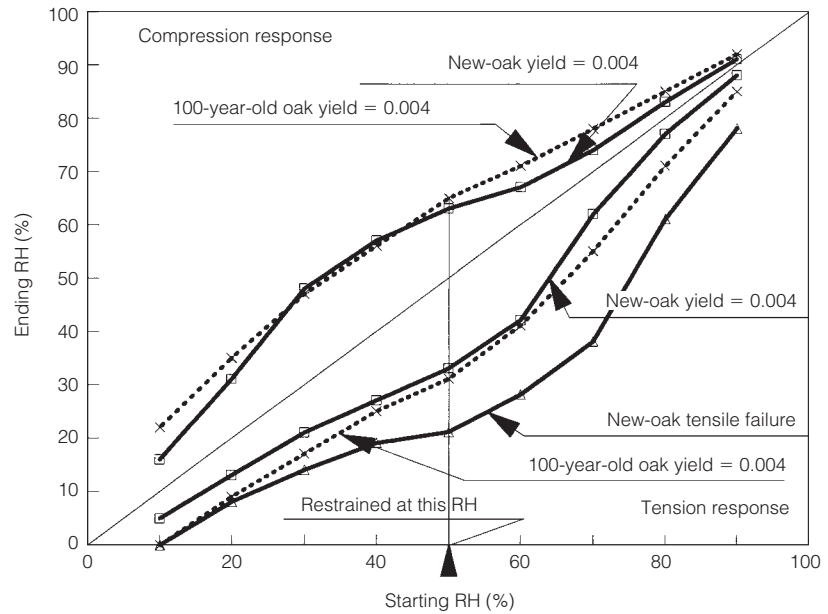
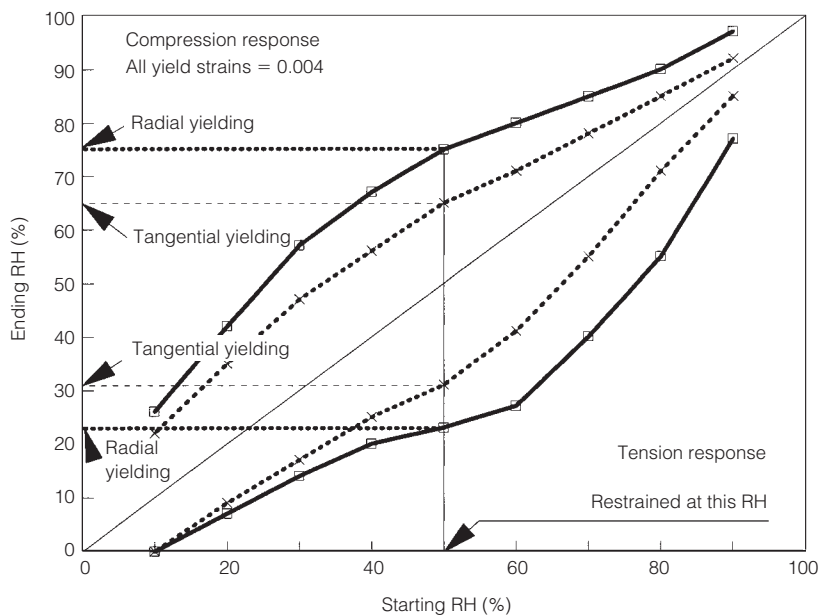

Figure 7

Calculated reversible RH range of fully restrained, 100-year-old, radially cut white oak versus ambient RH, compared to 100-year-old tangentially cut oak. A yield value of 0.004 was used as the limiting criterion in both tension and compression. It is assumed that the wood has been fully equilibrated to 50% RH. The significant increase of allowable RH in the radial direction demonstrates the advantages of preparing panel supports in that direction.



calculated RH changes required to reach yield in both the radial and tangential directions for 100-year-old white oak. If it is assumed that the panels had been restrained at 50% RH, the RH change required to cause yielding in tension is a decrease to 31% in the tangential direction and to 23% in the radial direction. An increase in RH to 65% would cause compressive yielding in the tangential direction; an increase in RH to 75% would cause compressive yielding in the radial direction. Because of its substantial increase in the allowable changes in RH, radial cutting is an important consideration for woods that are to be acclimated and restrained at high RH. In Figure 8 the restrained panels are shown as equilibrated to 70% RH. In the radial direction the wood would be capable of sustaining a drop to

Figure 8

Calculated reversible RH range of fully restrained, 100-year-old, radially cut white oak versus ambient RH, compared to 100-year-old tangentially cut oak. A yield value of 0.004 was used as the limiting criterion in both tension and compression. It is assumed that the wood has been fully equilibrated to 70% RH. The significant increase of allowable RH in the radial direction demonstrates the advantages of preparing panel supports in that direction. This consideration is particularly important in the case of panels equilibrated to high RH levels.

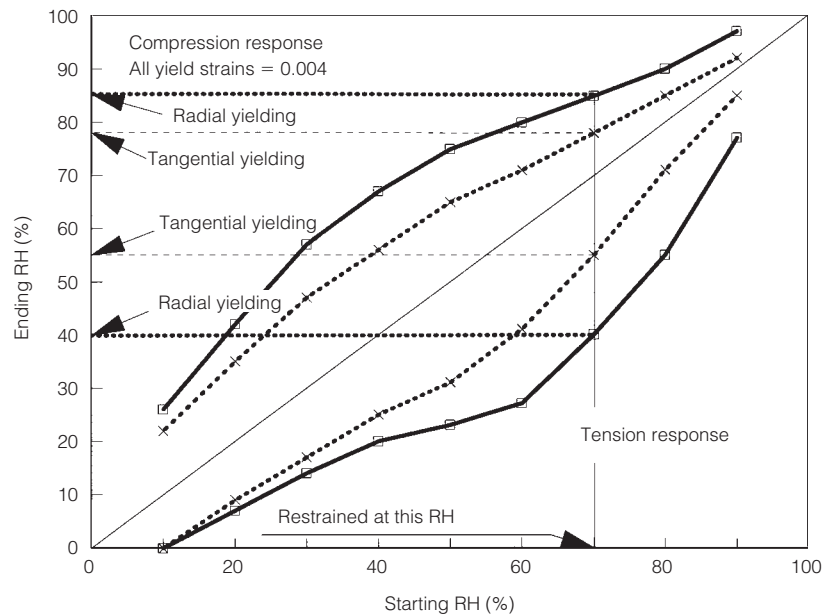

40% RH before yielding in tension, and capable of sustaining an increase to 86% RH before compression set begins. In the tangential direction, the panel is restricted to a range of 55–79% RH. The implications of these results are clear: panels cut in the tangential direction present a significantly greater risk of movement, particularly if acclimated to a high RH. In contrast, restrained panels cut in the radial direction are low risk, even if they have been acclimated to 70% RH.

The above examples help illustrate the response of wood to RH. Knowledge of the history, wood type, treatment record, and grain orientation of a panel painting is highly useful in helping to determine its potential risk from changes in RH and its subsequent potential for safe travel. This study used the extremes of conservative yield criteria and assumptions of worst-case full restraint.

Response of the design layers to RH

Until now, only the wooden panel has been discussed. However, it is also important to examine other components of the panel, such as gesso and oil paint layers. Since paint and gesso have very similar dimensional responses to changes in RH over most of the RH range, similar effects will occur when these layers are considered as coatings on panels that are both restrained and unrestrained (i.e., without battens, cradles, or framing techniques).

The primary difference between the two materials is that paint will be assumed to yield at a strain of 0.004 and gesso at a strain of about 0.0025. Therefore, while gesso and paint do have similar dimensional responses to changes in RH, the gesso will yield sooner to those changes than will the paint. As was seen with the wood, once paint or gesso is beyond the yield point, nonreversible strains occur. Depending on the environment to which the panel is acclimated, damage can be anticipated if the equilibrated RH deviations are well in excess of those causing yielding. Since not all paintings have gesso layers, the following comments will

distinguish between the effect of RH on panels having both gesso and paint layers and the effect on panels having paint directly applied to the wood.

Unrestrained wooden panels in the tangential direction exhibit substantial dimensional fluctuations with RH changes. If the swelling coefficients of expansion of all materials applied to the wood panel are the same as those of the wood, then RH variations will induce no stresses in the attached layers. If the swelling coefficients differ, mechanical stresses and strains will develop as a result of RH changes. For example, in the longitudinal direction of a panel painting, the wood is minimally responsive to RH. The paint and gesso coatings are responsive, but the wood restrains these layers from shrinking and swelling with changes in RH. In the tangential direction, however, the wood is much more responsive to RH variations than the gesso or paint. The responsiveness of the wood also creates stresses and strains in the design layers. In effect, the wood is overriding the response of the design layers.

The mechanical strains in the paint and gesso layers can be calculated using Equation 2. This equation can be used for any material applied to any substrate, provided the substrate is substantially thicker than the applied layers. (To check this equation, assume that the coefficient of expansion for the substrate is zero; Equation 2 would then simplify to Equation 1.) Equation 2 is

$$\Delta\Sigma_p = [(1 - \int\alpha_s dRH) - (1 - \int\alpha_p dRH)] / (1 - \int\alpha_s dRH) \quad (2)$$

where: α_s is the swelling coefficient of the substrate, which is thick relative to any attached layers; and α_p is the swelling coefficient of the coatings, either flake white paint or gesso. In our examples white oak is the substrate.

Response of the design layers to RH: Panels cut in the tangential direction

In Figure 9 the calculated mechanical strains for flake white oil paint and gesso (calcium carbonate and hide glue) on an unrestrained white oak panel are plotted versus RH. The paint, gesso, and wooden support panel are considered to be equilibrated to 50% RH, with initial stresses and strains of zero. The strains are plotted versus RH in both the tangential and longitudinal directions of the wooden panel support. In the longitudinal direction, the wood acts as a full restraint to the applied coatings (paint and gesso), and strains remain low over most of the RH range. The oil paint and gesso are minimally responsive to moisture—for the paint, the plot shows that it is possible to desiccate from 50% to 8% RH before tensile yielding occurs. Compressive yielding in the paint occurs when the RH is raised from 50% to approximately 95% (note that the paint is yielding, not breaking). However, in the gesso (which yields at a lower strain), the range for acceptable RH is narrower. In this case, tensile yielding will occur at approximately 19% RH, and compressive yielding at approximately 83% RH. This indicates that fairly large RH variations can occur without yield in the design layer. However, it is well known that cracks do develop perpendicular to the grain of the wood, indicating that the stresses and strains are parallel to the grain. This study shows that these cracks do not usually occur as a result of moderate RH changes. Drops in temperature are more likely to cause these types of cracks, as will be discussed below.

Figure 9

Calculated strains in gesso and flake white oil paint applied to an unrestrained, tangentially cut white oak panel versus RH. The panel painting is assumed to be equilibrated to 50% RH. Both the gesso and paint have fairly large allowable RH fluctuations, even in the tangential direction of the wood.

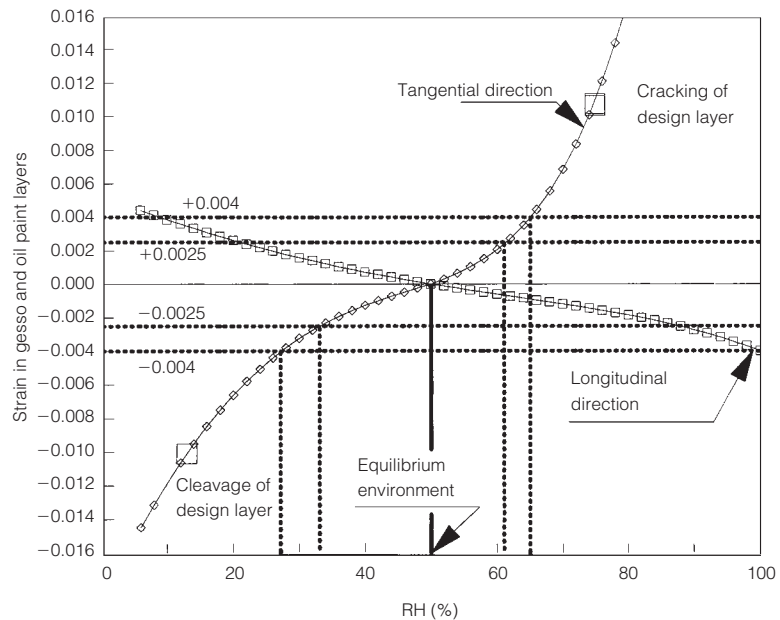

As it responds to the moisture changes, the wooden substrate significantly affects the mechanical strains in both the paint and the gesso layers. The strains of the design layers actually become compressive with desiccation, because the wood shrinks at a greater rate than either the paint or gesso—the gesso yields at 33% RH, and the paint yields at 27% RH. Further desiccation from the yield points causes permanent deformation in both layers. If the desiccation continues below 15% RH and the gesso ground is not firmly attached, crushing may occur, and cleavage ridges will develop parallel to the grain.

Raising the RH above 50% causes a different problem. At approximately 62% RH, the gesso begins to yield in tension; at about 65% RH, the paint begins to yield in tension. At about 75% RH or above, strains in the design layer can be high enough to induce cracking in a brittle gesso layer. This cracking of the gesso can subsequently crack the paint film applied above it. These cracks appear parallel to the grain of the wooden support panel. If no gesso layer is present, paint cracking would not begin until well above 85% RH.

Diagrams similar to that in Figure 9 demonstrate the response of gesso and paint layers attached to the panel when they are equilibrated to RH levels other than 50%. Figure 10 shows the calculated resulting strains developed in the paint and gesso when the panel painting has been equilibrated to 64% RH. Tensile yielding in the paint now occurs at about 43% RH (higher than when the painting was acclimated to 50% RH). At 53% RH the gesso yields in tension. A 14% variation (50–64% RH) in the equilibrium environment will have a major effect on the dimensional response of the panel. This panel is to some degree restricted to a narrower and higher environment, as compared to a panel equilibrated to 50% RH. If, however, the equilibrium environment is higher (e.g., about 70%), greater differences will occur in the response of the panel to the environment. This is illustrated in Figure 11, which shows the calculated strains of the design layers applied to a panel equilibrated to 70% RH. Under the condi-

Figure 10

Calculated strains in gesso and flake white oil paint applied to an unrestrained, tangentially cut white oak panel versus RH. The panel painting is assumed to be equilibrated to 64% RH. The paint still has a fairly large allowable RH fluctuation, even on the tangentially cut wood, but the gesso is now confined to a more restricted RH range.

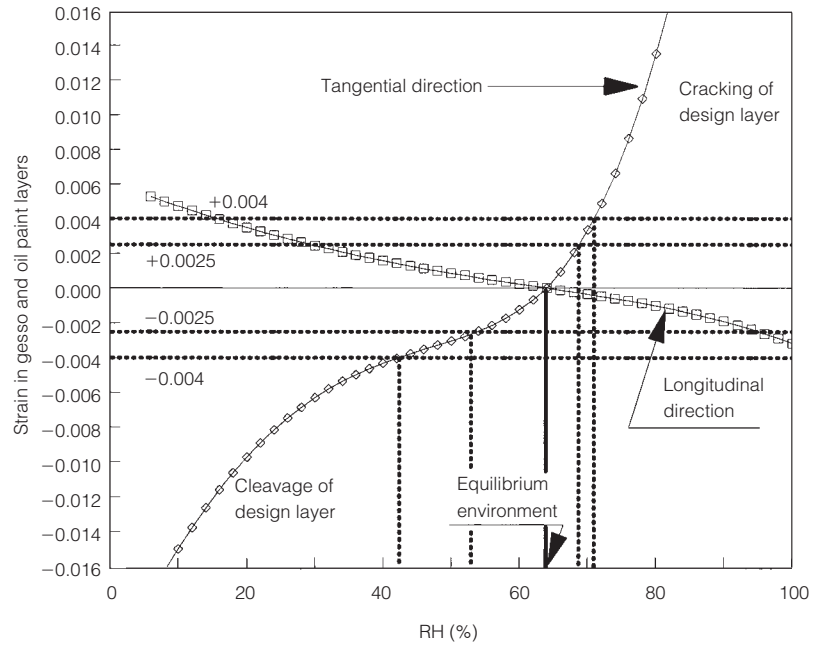

tions in this example, the gesso layer will yield with a drop in RH from 70% to 64%, and the paint will yield when the RH drops to 60%. Crushing or cleavage of the design layer could occur at about 35% RH if the gesso ground is not sound. A panel equilibrated to a high level of RH will suffer some permanent deformation if subjected to the well-controlled environments found in many institutions. In addition, a smaller increase in RH, (6–8%), is needed to cause tensile yielding when compared to a panel equilibrated to 50% RH.

How realistic is the example above? At such a high RH level, there is a strong potential for biological attack that should be observed and noted. For a panel's RH to equilibrate to a high annual mean, RH levels during the more humid periods of the year must also be high. Evidence of

Figure 11

Calculated strains in gesso and flake white oil paint applied to an unrestrained, tangentially cut white oak panel versus RH. The panel painting is assumed to be equilibrated to 70% RH. Both the gesso and paint are now confined to a very restricted RH range in the tangential direction. This painting would be at serious risk if subjected to low RH levels.

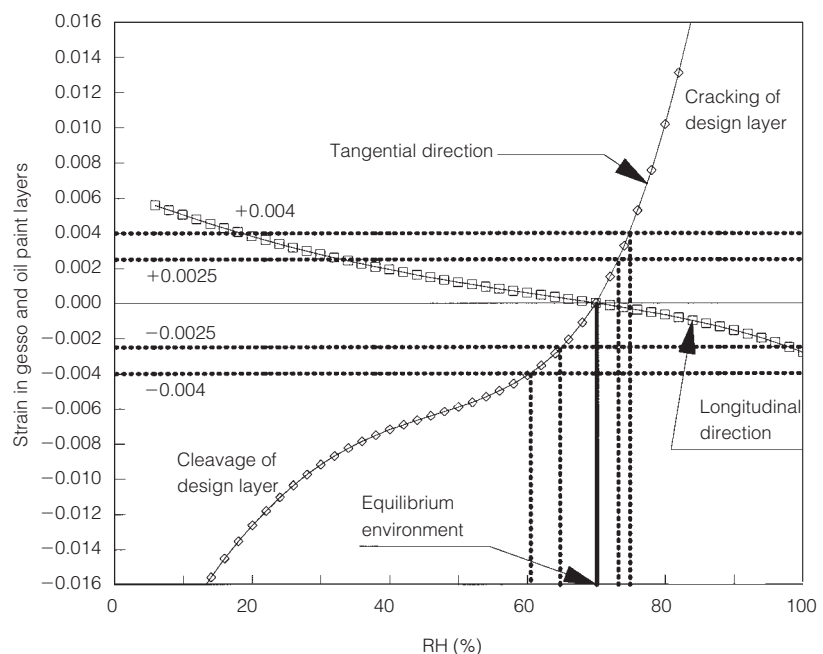
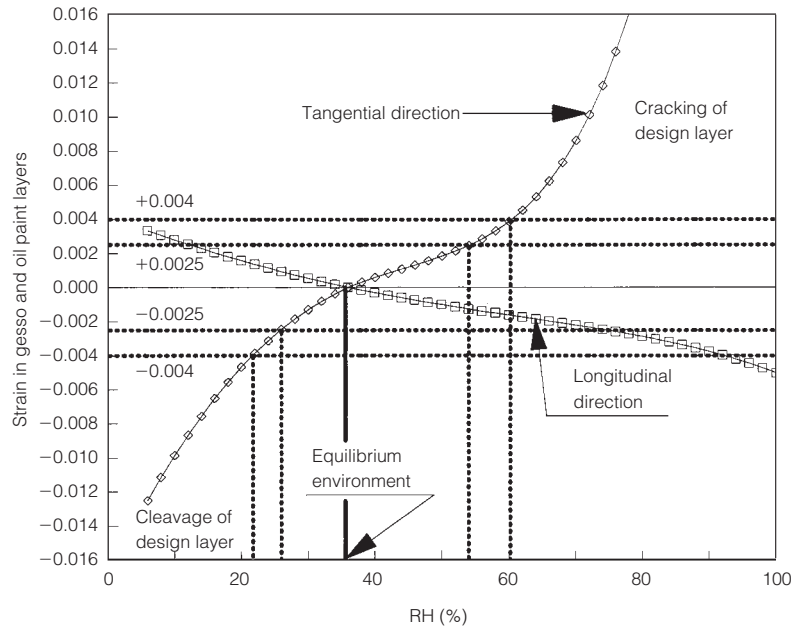

Figure 12

Calculated strains in gesso and flake white oil paint applied to an unrestrained, tangentially cut white oak panel versus RH. The panel painting is assumed to be equilibrated to 36% RH. Both the gesso and paint have large allowable fluctuations of RH, even in the tangential direction. This painting would not be at risk unless it were subjected to RH levels above 55%.



mold damage could be an important indication that a panel painting may have equilibrated to an excessively high humidity and therefore is a less-than-suitable candidate for shipment.

If a panel painting has equilibrated to an environment lower than 50%, the RH changes needed to cause yielding are not significantly affected. Figure 12 shows the calculated results for a painting equilibrated to 36% (rather than 50%) RH. Note that with a 14% downward shift in the equilibrium environment, only about a 6% downward shift in the RH is necessary to attain compressive yielding in both the gesso and the paint layers. The panel painting equilibrated to this low-RH environment can still sustain significant deviations in the mid-RH range without yielding. In addition, the painting has to drop to 26% RH for yielding in the gesso to occur, and to 22% RH for yielding in the paint to occur.

Response of the design layers to RH: Panels cut in the radial direction

Paintings executed on radially cut wooden panels are at reduced risk during transport, and the layers applied to such panels are far less likely to suffer RH-related damage. Figure 13 illustrates the different responses of the design layer to the unrestrained movement of white oak. In the longitudinal direction, there is little difference between tangentially and radially prepared panels, and the strains in the gesso and paint layers are similar to those shown in Figure 9. (As before, the assumed yield strains are 0.004 for the paint and 0.0025 for the gesso.)

In a panel cut in the radial direction and acclimated to 50% RH, gesso shows compressive yielding at 22% and shows tensile yielding at 79%. In a panel cut in the tangential direction, the gesso shows compressive yielding at 33% RH and tensile yielding at 63% RH. If there is no gesso layer, the paint film attains compressive yielding at 13% RH and tensile yielding at 86% RH. These RH values are not substantially reduced from the RH yield points of the paint in the longitudinal direction. The

Figure 13

Calculated strains in gesso and flake white oil paint applied to unrestrained, radially and tangentially cut white oak panels versus RH. The panel paintings are assumed to be equilibrated to 50% RH. Both the gesso and paint have large allowable fluctuations of RH, even in the tangential direction, but the radial direction shows a significant increase in the allowable fluctuations over the tangential cut.

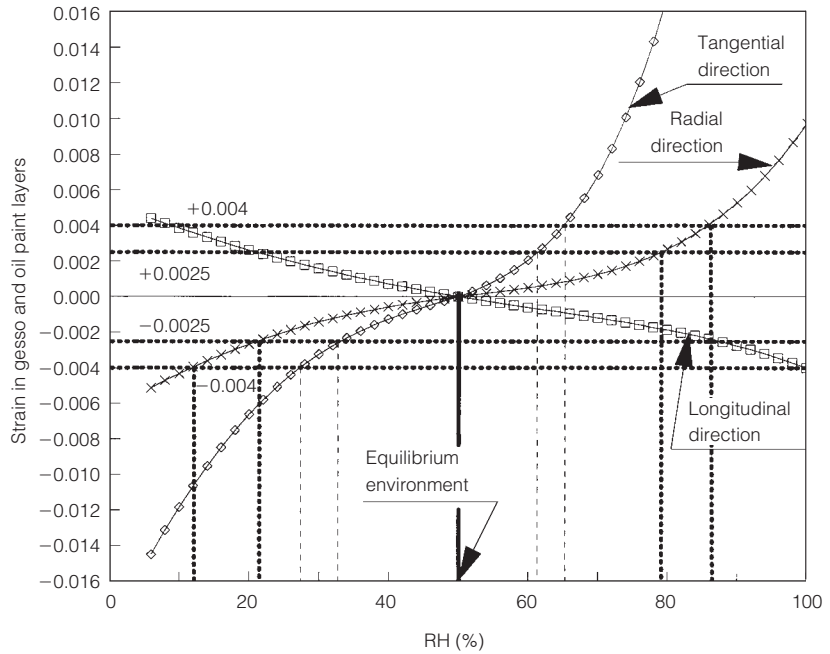

difference is that with desiccation, the paint and gesso experience compression in the cross-grain direction and tension in the longitudinal direction, while increases in humidity induce the opposite reaction. Both the wood and the design layers are more stable on a radially cut panel.

Of significant interest is the response of the design layers that have been applied to radially cut oak and equilibrated to a high RH. In Figure 14, the calculated strains in the paint and gesso layers applied to radially cut oak and equilibrated to 70% RH are given. When desiccation occurs, compressive yielding occurs in the gesso at 32% RH and in the paint at 19% RH. Upon equilibration to 50% RH, tensile yielding in the gesso occurs at 85% RH and in the paint at 90% RH. This is a sub-

Figure 14

Calculated strains in gesso and flake white oil paint applied to unrestrained, radially and tangentially cut white oak panels versus RH. The panels are assumed to be equilibrated to 70% RH. Both the gesso and paint have very small allowable fluctuations of RH in the tangential direction, but the radial direction shows a significant increase in the allowable fluctuations. Where the tangentially cut panel is at risk when equilibrated to high RH, the radially cut panel can still sustain large RH fluctuations.

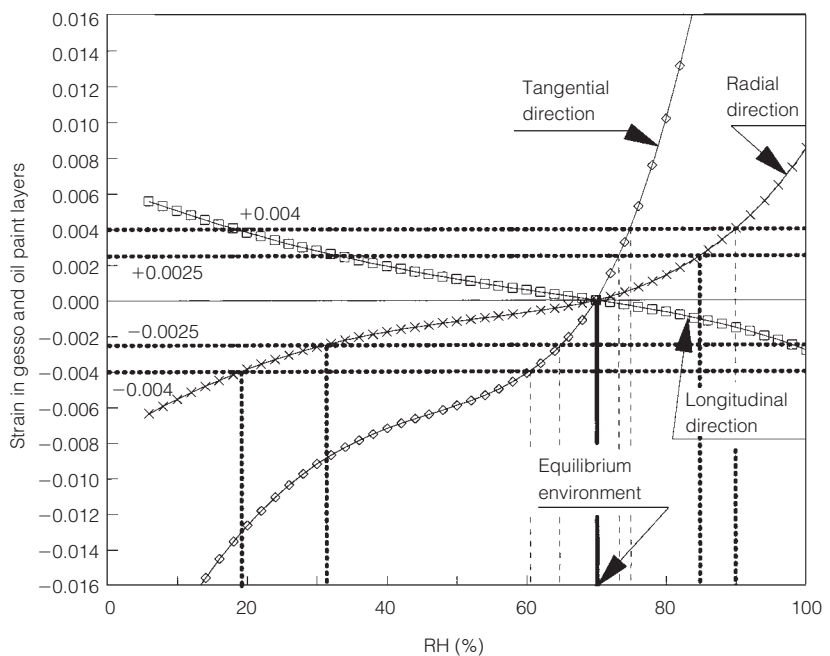

stantial improvement over the strains that developed in the design layers that were applied to tangentially cut wood. Panels cut tangentially and equilibrated to a high RH are at serious risk if desiccated. Panels cut radially are at considerably less risk, even when desiccated and equilibrated to a high RH. For example, paintings on plywood panels that are made entirely of restrained, tangentially cut wood fare poorly when exposed to RH fluctuations, as compared to paintings on radially cut panels, whether restrained or not.

The equilibrium RH of a panel painting's environment establishes its risks for transport. Knowing the equilibrium RH allows for the development of environmental guidelines for both the transit case and the new, temporary exhibition space. Tangentially cut panels acclimated to high RH are at risk. This risk can occur when warped panels have been flattened with moisture before the addition of battens or cradles. In such instances a warped panel is often thinned, moistened on the reverse, and finally attached to battens or a cradle to forcibly hold the panel flat. As a result, considerable tensile stress can build up as the wood dries, since the battens or constricted cradles can restrict the return to warpage.

When panels are thinned, there are other consequences. Decreasing the thickness reduces the bending stiffness of a panel and makes it more flexible. The reduction in stiffness is inversely proportional to the cube of the thickness of the panel (Weaver and Gere 1965:115–17). This thinning makes the panel prone to buckling when restrained. At a high RH, a panel with a locked-in cradle is subjected to high RH-induced compressive stresses in the spans between the cradle supports, and because of the cradle, such stresses are not uniform. They cause out-of-plane bending or buckling of thinned panels.

It is important to assess whether a panel's movement is restricted—an assessment that may be difficult in some cases. Panels with battens or cradles that have locked up by friction present higher risks for transport if they are cracked or if the panel has equilibrated to a very high RH environment (Mecklenburg and Tumosa 1991:187–88). In addition, research suggests that an unrestrained panel with a gesso layer equilibrated to a high-RH environment is at greater risk of damage upon desiccation than is a sound (free of cracks), restrained panel. This risk occurs because the gesso layer is subject to compression cleavage when an unrestrained panel contracts from desiccation. Almost all the panel paintings of the fifteenth- and sixteenth-century Italian Renaissance have gesso grounds. This gesso layer and the wood panel itself should be considered the crucial components when the movement of such paintings is contemplated.

In contrast, oil paintings on copper supports seem to have fared well over the centuries. Research shows that oil paint responds only moderately to changes in RH, particularly if extremely high RH levels are avoided. Additionally, copper is dimensionally unresponsive to RH fluctuations. The combination of these two materials results in a painting that is durable with respect to changes in atmospheric moisture.

Contemporary panel paintings having wooden supports and either acrylic or alkyd design layers may also be analyzed in relation to the criteria discussed above. Figure 15 shows the coefficients for swelling of alkyd and acrylic emulsion paints compared to those of oil paint. All of these paints have dried for fifteen years or more under normal drying conditions. Both the alkyd and the acrylic emulsion paints are much less dimensionally responsive to moisture than is oil paint. When acrylic paints are

Figure 15

Moisture coefficients of expansion versus RH for oil, alkyd, and acrylic paints. The dimensional responses of the alkyd and acrylic paints are substantially lower than those of the oil paint.

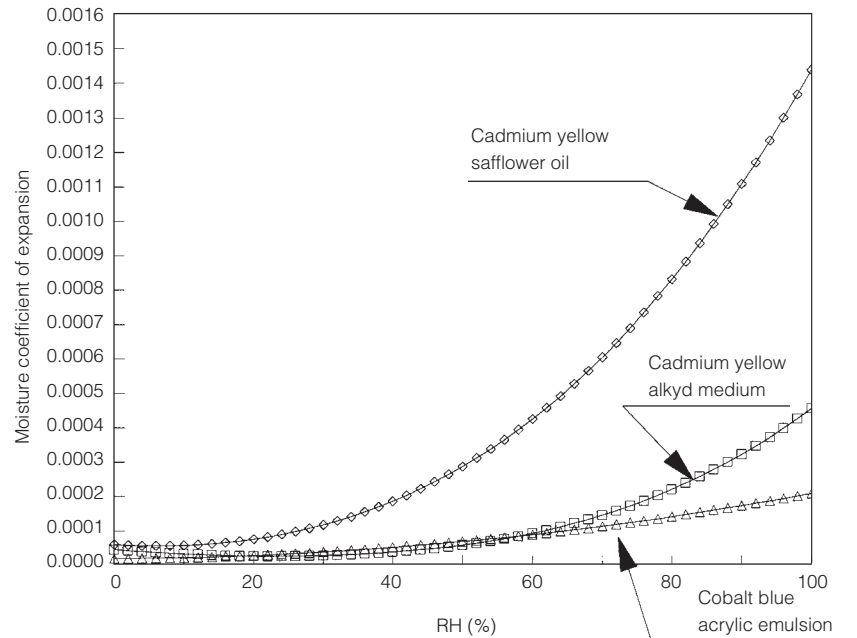

applied to a wooden panel, RH changes have very little effect in the longitudinal direction of the wood. In the tangential direction, the movement of the paint is almost totally dictated by the movement of an unrestrained wooden panel. However, the RH change needed to develop yield in alkyd or acrylic paints will be approximately 2–3% less than the change needed for oil paint on wooden panels because the moisture coefficient of expansion of the oil paint is higher.

Control of transport RH

RH levels may also vary during transport, but fortunately this problem can be solved with proper packing. Since the RH levels in trucks depend largely on weather conditions, the RH inside even an air-conditioned truck may be very high on a hot, humid day. If the weather is very cold, the RH in the truck may be low because of the drying effects of the cargo-area heating system. At high altitudes, the RH in a heated and partially pressurized aircraft cargo space is always low—often as low as 10–15%. Panel paintings exposed to this extreme desiccation for the duration of an average flight could be damaged. This desiccation can be avoided if the painting is wrapped in a material that functions as a moisture barrier (wrapping of panel paintings is discussed further below).

Temperature Effects

The dimensional response of wooden panels to temperature variations has been largely ignored by many conservators, because temperature has been considered to have a much smaller effect on wood than has RH. This precept holds true if one considers only the relative dimensional response of wood to temperature as compared to its response to moisture. It would take a change of several hundred degrees in temperature to induce the same dimensional change in wood that can be caused by a large change in RH. Panel paintings are rarely exposed to such temperature extremes, and they are usually exhibited or stored where temperature variations are relatively small. The problem, however, is not so much the response of the

Table 1 Thermal coefficients of expansion of selected painting materials

Material	Thermal coefficient of expansion
White oak—longitudinal	0.0000038/°C
White oak—tangential	0.0000385/°C
White oak—radial	0.00003/°C
Oil paint	0.000052/°C
Gesso	0.00002/°C
Hide glue	0.000025/°C
Copper	0.000017/°C

wood as it is the response of the gesso and paint layers. Therefore, when the effects of temperature are considered, it is also necessary that the mechanical properties of the different paint media, as well as their dimensional responses, are understood. In the temperature ranges most likely to be encountered, the thermal coefficients of expansion for the materials found in panel paintings can easily be considered as constants. Some values for these materials are given in Table 1.

To determine the effect of temperature on paint or gesso applied to different substrates, it is again possible to use Equation 2. Note that changes in temperature will change the moisture content of materials even when the ambient RH is held constant. At a constant RH, heating will desiccate materials somewhat, and cooling will increase their moisture content. The following discussion does not take these effects into account. Figure 16 plots the calculated mechanical strains of flake white oil paint directly applied to panels in the longitudinal, tangential, and radial directions of the wood, and to a copper panel as well. Because the thermal coefficient of expansion of the paint is greater than the thermal coefficient of wood in any direction, the paint responds to drops in temperature by developing tensile strains. The wood's shrinkage in the tangential and radial directions relieves a considerable amount of the paint strain, since the coefficients in these directions more closely match those of the paint. In the longitudinal direction of the wood, the coefficient is the smallest and strain relief to the paint the lowest. Hence, the greatest mechanical strain increase in the paint occurs in the direction parallel to the grain of the wood. As the temperature drops, the paint may pass through its glass-transition temperature (T_g). At this approximate temperature, the paint undergoes a transition from ductile to very brittle and glassy. Below T_g , the paint is very fracture sensitive and prone to crack under low stresses and strains. In this example, cracks could result when the strains reach levels as low as 0.002. In the longitudinal direction of a wooden panel painting, cracking occurs if the temperature drops from 22 °C to approximately -19 °C. A copper panel painting, however, requires a temperature drop to -35 °C to produce the same strain level.

Figure 16 Calculated temperature-related strains in flake white oil paint when applied to white oak and copper. The paint strains in the longitudinal direction are the highest, and failure can most likely occur when the temperature drops below the glass-transition temperature (T_g). This type of failure results in cracks in the oil paint perpendicular to the grain of the wood.

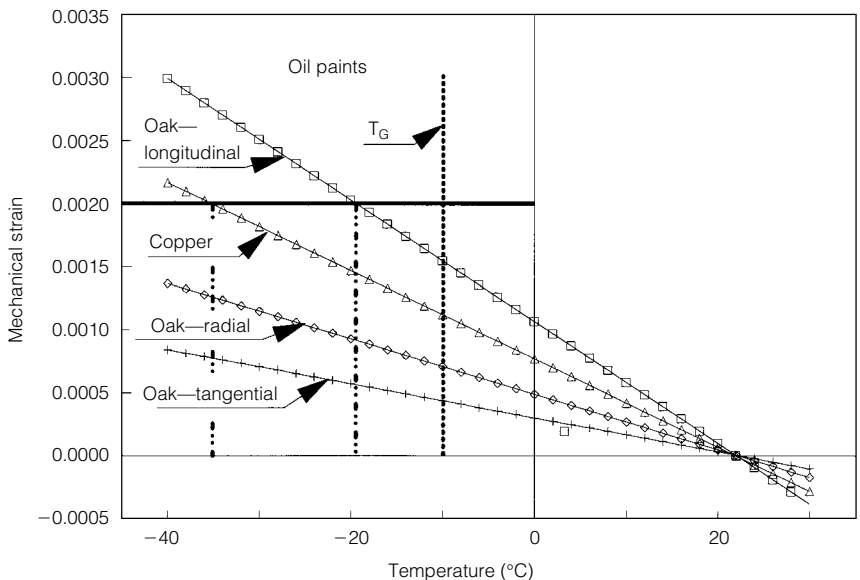

Cracking in varnish and polyurethane coatings on wood has, in fact, been recorded when the temperature has dropped from 24 °C to -20 °C. In the radial and tangential directions of the wood, the temperature must drop to well below -50 °C to produce similar strains in the oil paint layers.

It is unlikely that cracks in oil paint layers could occur perpendicular to the grain of the wood because of RH variations. However, with regard to temperature, even moderate subfreezing temperatures can crack oil paint in this direction. Low temperatures are less likely to cause cracking of paint parallel to the grain, unless the wooden support panel is fully restrained from thermal movement during the temperature drop. As Figure 16 shows, oil paint layers applied to copper can survive a substantial drop in temperature. Note that resultant embrittlement of the paint layer is far more severe when it is exposed to low temperature at moderate RH than when exposed to low RH at room temperature.

Other paint media suffer embrittlement similar to that suffered by oil paint, but at higher temperatures. With alkyd paints, a T_g occurs at approximately -5 °C, while with acrylic paints, it occurs at approximately 5 °C. While unlikely, it is possible for the temperature inside packing cases to drop to 5 °C in the cargo holds of aircraft, on the airport tarmac, or inside an unheated truck. T_g should be considered the lowest allowable temperature for a safe environment, because embrittled materials are more vulnerable to damage.

The effect of temperature on gesso applied to wooden panel paintings is different from the effect of the same temperature on paint applied to wooden panels. In general, gesso has a low thermal coefficient of expansion that is higher than that of the longitudinal direction of white oak and lower than the oak coefficients in the radial and tangential directions. Figure 17 plots the calculated temperature-related mechanical strains in the three different grain orientations for a gesso coating applied to a white oak panel. First, the developed mechanical strains are minimal, even at -40 °C. In the longitudinal direction the gesso strains are tensile, and in the tangential and radial directions they are compressive. Thus, it

Figure 17

Calculated temperature-related strains in gesso when applied to white oak. The gesso strains in the longitudinal (tensile) and cross-grain (compressive) directions are never very high, and failure is not likely to occur, even if the temperature drops significantly.

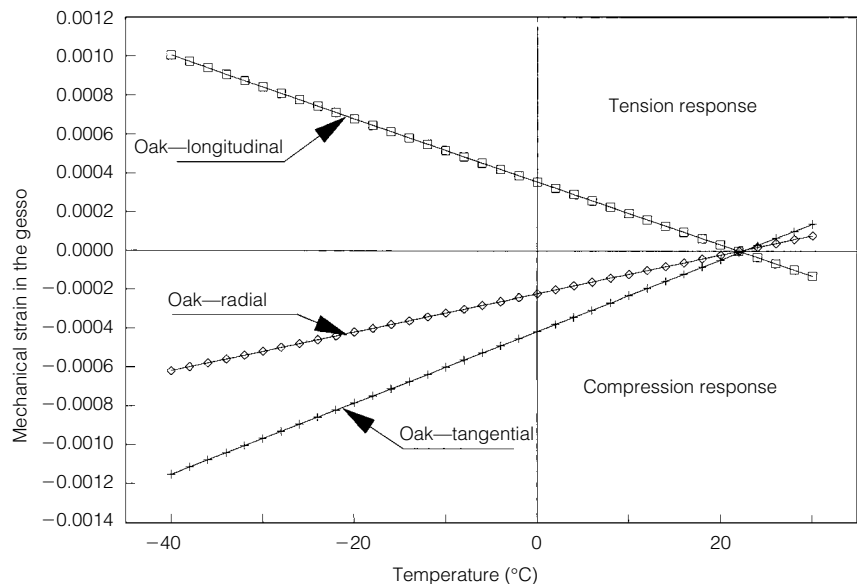

appears that temperature has a significantly smaller effect on gesso than it has on oil paint.

In the panel itself, the most probable damage would occur in the tangential direction if the wood were fully restrained and subjected to a drop in temperature. The tangential direction has the highest thermal coefficient of expansion and the lowest strength. However, even in this direction, a drop in temperature from 22 °C to -40 °C causes a mechanical strain of only 0.00246, which is not a serious concern for wood.

Excessive heat can cause undue softening of paint and varnish layers and therefore is to be avoided. In the transport environment, temperature changes can be great enough to cause damage to the paint (and varnish) layers. Thus, precautions must be taken to avoid exposing panel paintings to extremes of hot or cold environments.

Temperature variations are inevitable in most transport situations (Saunders 1991; Ostrem and Godshall 1979; Ostrem and Libovicz 1971). Although variations are usually minimal during a local move in a climate-controlled vehicle, they can grow extreme during a long truck trip during harsh winter months. In the northern United States and Canada, for example, winter lows of -20 °C are typical, and temperatures of -40 °C are possible. These extremely low temperatures can cause damage to panel paintings and must be avoided.

In the summer, temperatures of 40–50 °C can be found in many parts of the world; because of solar heating, temperatures inside stationary vehicles can be even higher. High temperatures are less likely to cause cracking in panel paintings, since heat softens the paint. However, varnishes can become tacky at high temperatures, causing wrapping materials to adhere to the panel surface. The use of climate-controlled vehicles for transporting works of art is the best way to minimize temperature variations, but contingency plans should be made in case of mechanical problems with vehicles or with their climate-control systems. Should a problem occur, insulation in packing cases will slow the rate of temperature change inside packing cases, but for only a short while (Richard 1991a).

Temperature variations can also occur in the cargo holds of aircraft. Cargo holds of all modern commercial aircraft now have heating systems, however, and barring mechanical failure, the temperature should not fall below 5 °C. Acrylic paintings are at high risk at these lower temperatures, but sound oil paintings on panel are not.

Shock

In addition to environmental variations, handling can add sufficient stress to a panel structure to cause paint loss, propagate cracks, separate joints, and permanently deform its wood.

Shocks in the transport environment are derived from three basic sources: handling before a work is packed, handling of the packing case, and the motion of the vehicle carrying the packing case. Shock levels in trucks and planes are low if packing cases are properly secured to the vehicle. In contrast, handling operations “are generally considered as imposing the most severe loads on packages during shipment” (Marcon 1991:123). “Packaging designers have achieved reasonable success in preventing shipment losses due to shock by designing packages and cushioning systems according to the presumption that shocks received during handling operations will be the most severe received by the packages during the entire shipment” (U.S. Department of Defense 1978:9).

Because old panel paintings are fragile, the shock level to which they are exposed must be minimized. The *fragility factor*, or *G factor*, is a measure of the amount of force required to cause damage, and is usually expressed in Gs. Mass-produced objects are destructively tested to measure their fragility, but obviously this test is not possible with works of art. Until recently, no attempt has been made to determine the fragility-factor range for panel paintings. Instead, art packers have relied on estimates. Conservatively, a packing case should ensure that a panel painting is not subjected to an edge-drop shock level greater than 40 G. The edge drop, however, is not the greatest concern.

One of the most serious accidents can occur when a painting resting upright on the floor and leaning against a wall slides away and falls to the floor. Another possible accident involves a case toppling over. In both of these handling situations, a panel painting is at serious risk because of inertially induced bending forces applied to the panel. The bending stresses induced in a panel are potentially the most damaging, and the thinner the panel, the greater the risk. While a thin panel has a low weight (low mass), for a given action, the bending stresses increase as a function of the inverse square of the thickness of the panel. For example, consider a sound, 2.54 cm thick white oak panel painting measuring 100 cm in the direction perpendicular to the grain, and 150 cm in the direction parallel to the grain. If this panel painting is bowed and supported in a frame, it is very likely that the support is along the two long edges (Fig. 18). If this painting were to topple so that the rotation were along one of the long edges, there would be bending stresses in the wood perpendicular to the grain. These stresses can be calculated by first determining the effective loading on the panel that results at the time of impact. If the impact were 50 G, the maximum bending stresses would be approximately 4.66 Mpa. This stress is calculated by first determining the shear (Fig. 19) and bending (Fig. 20) resulting from the impact forces. White oak has a specific gravity of approximately 0.62, which means that it has a density of approximately 0.171 kg cm⁻³. At 50 G, the density of the wood is 0.032 kg cm⁻³ along the impact edge and diminishes to zero at the rotating edge. For a 2.54 cm thick panel, the loading for every 2.54 cm of width of the panel at the impact edge is 0.032 kg cm⁻³, and the loading tapers to zero at the other edge (Fig. 18). From the bending moment diagram, the bending stresses can be calculated from the equation

$$\sigma = M_c / I \tag{3}$$

where: σ is the bending stress, in either tension or compression, at the outer surfaces of the panel; M is the bending moment calculated and shown in Figure 20; c is one-half the thickness of the panel; I is the second area moment of the cross section of the panel segment under consideration, and $I = bd^3 / 12$, where b is the width of the panel section, and d is the thickness of the panel.

The calculated bending stresses resulting from a 50-G topple impact to a 100 × 150 × 2.54 cm thick oak panel are shown in Figure 21. The maximum stresses are stationed approximately 58 cm from the rotating edge and reach 4.88 Mpa. This amount is slightly more than half the breaking strength of structurally sound oak in the tangential direction.

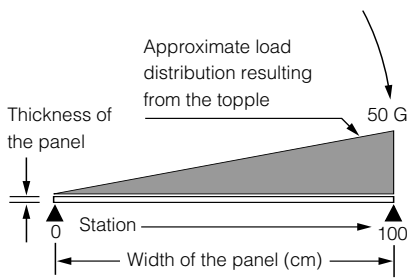

Figure 18
Approximate loading that occurs to a panel painting subjected to a 50-G topple accident. In this case, it is assumed that the panel is supported only along the two parallel-to-grain directions. It is always better to support the panel continuously around the edges.

Figure 19

Shear in newtons (N) for a 2.54 cm wide strip of a 100 × 150 × 2.54 cm thick panel subjected to a 50-G topple accident.

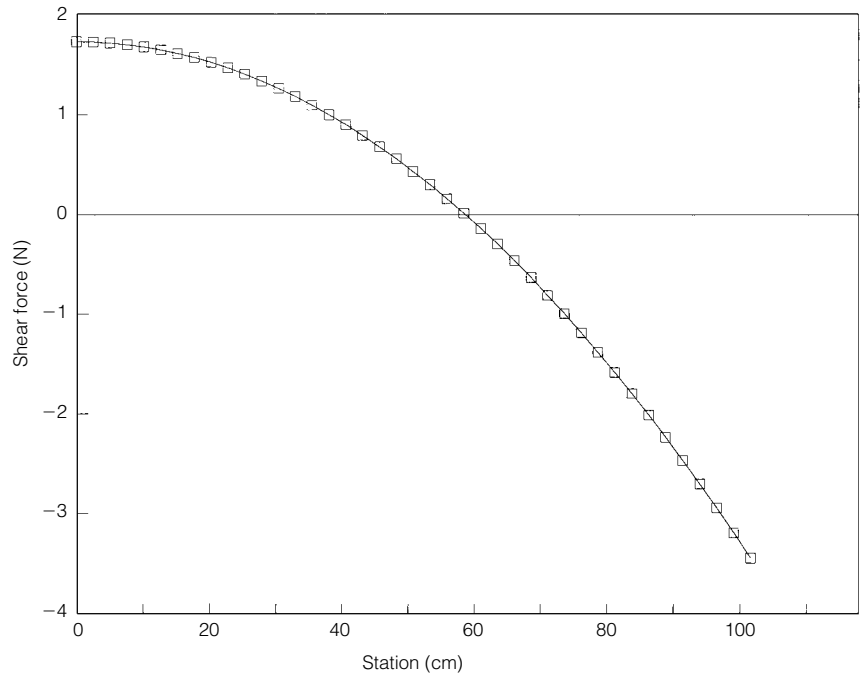
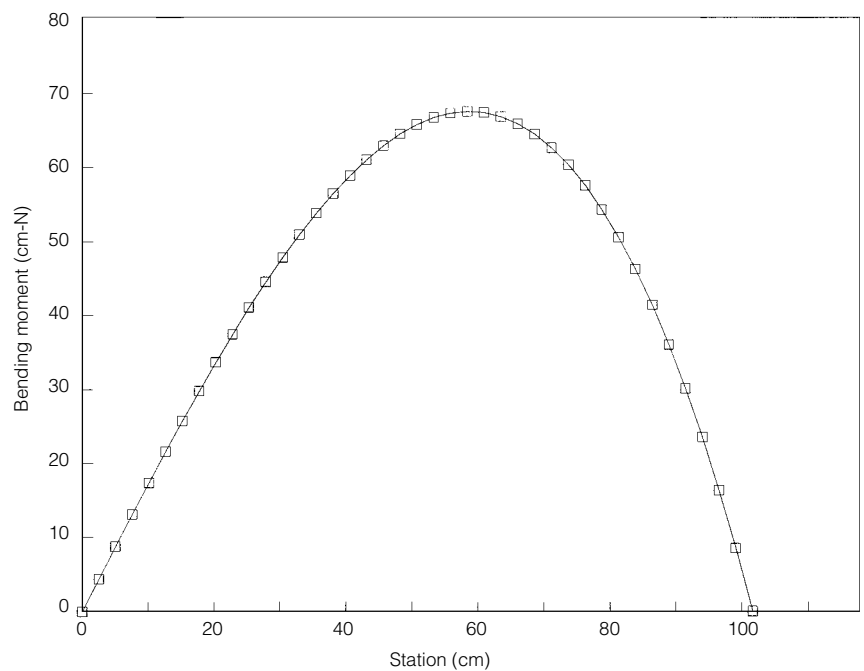

Figure 20

Bending-moment diagram for a 2.54 cm wide strip of a 100 × 150 × 2.54 cm thick panel subjected to a 50-G topple accident. The bending moments of panels subjected to topples can be quite high.



If the same event occurred to an oak panel 1.25 cm thick (with the other two dimensions the same), the bending stresses would be 9.8 Mpa. Even though the 1.25 cm thick panel weighs half as much as the 2.54 cm one, it incurs twice the stress. The measured breaking stress of white oak at room temperature and 50% RH is approximately 8.9 Mpa. The thinner panel will likely crack in a 50-G topple accident. The 2.54 cm thick panel would require a 100-G topple impact to crack it. If either panel were supported continuously around the edges, the risk of damage would decrease by a factor of five.

Figure 21

Distribution of the calculated bending stresses for a 2.54 cm wide strip of a 100 × 150 × 2.54 cm thick panel subjected to a 50-G topple accident. The bending stresses of panels subjected to topples can be quite high, and in this case they reach about one-half the breaking stress of oak in the tangential direction. Thinner panels are at even greater risk.

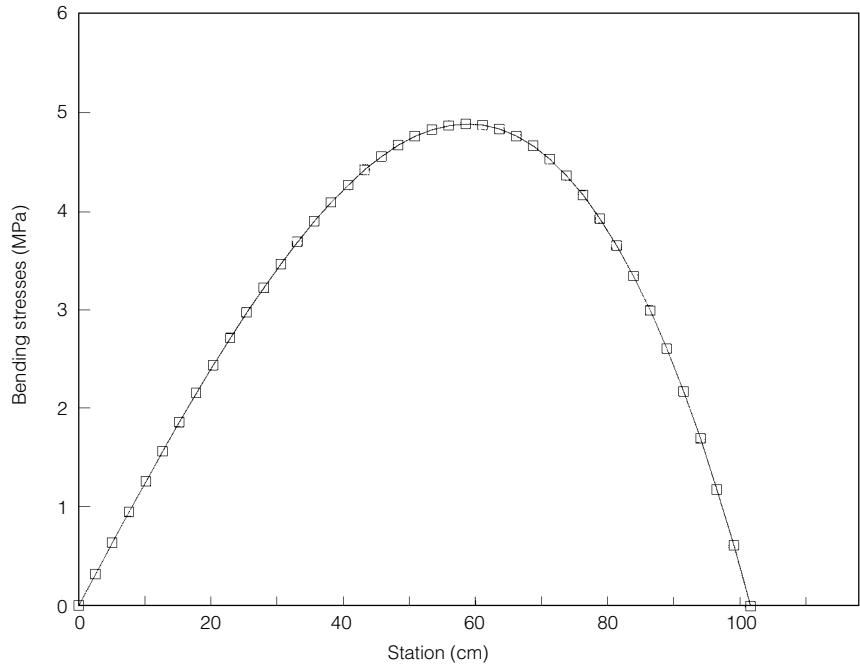
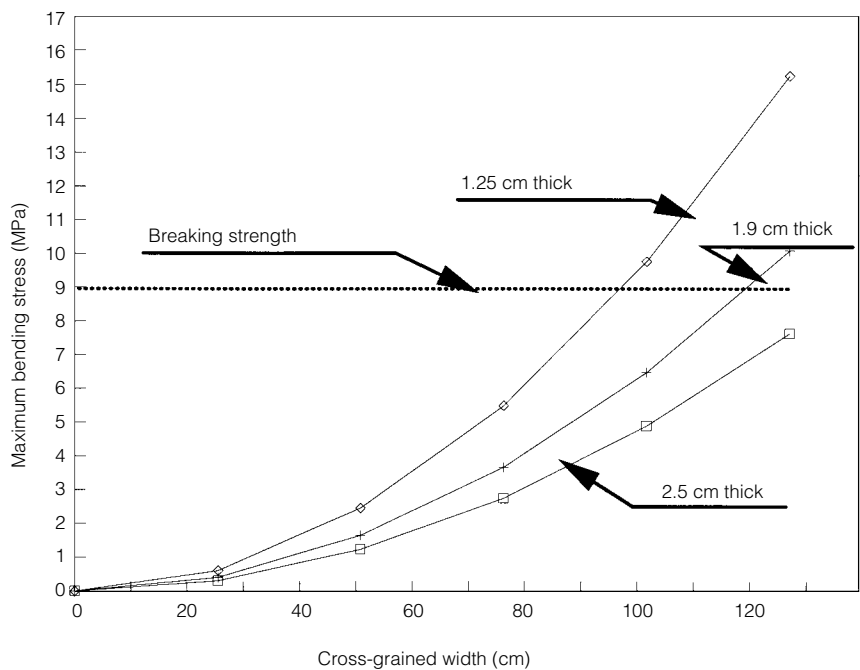

Figure 22 shows the calculated bending stresses of oak panels of different sizes and thicknesses subjected to 50-G topple impacts. These panels are assumed to be supported on the parallel-to-grain edges only, and the topple is a rotation of one of those edges. For this test, it is also assumed that there are no battens or cradles attached to the reverse, since they would provide a certain degree of bending protection.

Panels constructed of lighter woods such as pine (*Pinus* spp.; specific gravity, 0.34) will develop comparatively lower bending stresses when subjected to a 50-G topple impact. However, the strength of the

Figure 22

Calculated maximum bending stresses for white oak panels of different thicknesses and sizes when subjected to 50-G topple accidents. These stresses assume that the panels are supported only on the two parallel-to-grain edges.



lighter wood is also lower, and the result is that the risk of damage is greater than for denser woods. Figure 23 illustrates the results of the calculated bending stresses for different thicknesses of oak and pine panels of 100 × 150 cm subjected to 50-G topple impacts. The breaking stress of the pine in the tangential direction is only 3.10 Mpa. As was the case with white oak, the thinner pine panels are at greater risk, and the pine panels must be thicker than oak panels to prevent failure under the same topple conditions.

This implies that a single packing criterion is not sufficient for the impact protection of panel paintings. Larger and thinner panel paintings obviously need greater protection than those that are smaller and thicker. In addition, in this analysis it is assumed that the panel is sound, since existing cracks reduce the total strength. Panel paintings should be supported continuously around the edges in a way that allows them to expand and contract with RH and thermal fluctuations. Special care should be taken to prevent topple accidents; one way to do this is to pack more than one painting in a case, effectively increasing the width of the case and reducing the possibility of a topple.

Panel paintings in the size range of 100 × 150 cm will often be thicker than 2.54 cm, and those that are thinner are probably supported by either battens or cradles. Yet a 2.54 cm thick oak panel that is 125 cm wide or greater will fail in a 50-G topple. Based on this information, a 30-G maximum impact criterion for topple should be considered reasonable.

It should not be difficult to provide 30-G topple protection for larger panels. For one thing, the risk for an edge drop is much lower. It is fairly easy to provide 40-G protection for edge drop heights of 75 cm or less, using foam cushioning materials (the use of foam cushioning to reduce shock will be discussed below).

Vibration

The primary sources of vibration in the transit environment come from the vehicles used for transport. “Trucks impose the severest vibration loads on cargo with the railcar next, followed by the ship and aircraft”

Figure 23
 Calculated maximum bending stresses for 100 × 150 cm white oak and pine panels subjected to 50-G topple accidents versus panel thickness. These stresses assume that the panels are supported only on the two parallel-to-grain edges. Even though the pine is a lighter wood, because of its substantially lower strength, panels made from it are at serious risk in the event of a topple.

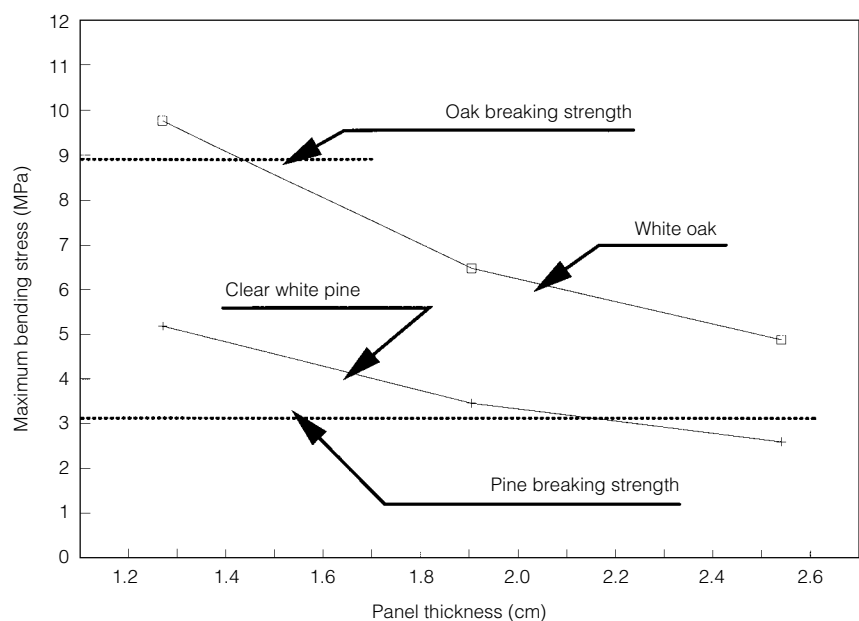

(Ostrem and Godshall 1979:29). In trucks, the main sources of vibration are the natural frequencies of its body, engine, tires, drive train, and suspension system. The properties of the road surface are also a factor. The vibration levels in vehicles are all relatively low and random in nature, as vehicles are usually designed for passenger comfort.

Low levels of vibration are unlikely to damage panel paintings unless sustained vibrations create resonant vibrations in the panel; the random nature of vehicle vibration makes this unlikely. In addition, the resonant frequencies of panel paintings are high, and those vibrations are easily attenuated by packing cases (Marcon 1991:112).

Packing Cases

There are many packing-case designs suggested for the transport of panel paintings. It is essential that all cases provide adequate protection against shock, vibration, and environmental fluctuations. Protection against the first two stresses is usually achieved through the use of foam cushioning materials. Although various cushioning materials are available for the transport of works of art, the most commonly used are polyethylene and polyester urethane foams. These foam products, along with polystyrene foam, can additionally function as thermal insulation. The proper use of these materials and information concerning the principles of case design are available in many publications (Mecklenburg 1991; Piechota and Hansen 1982; Richard, Mecklenburg, and Merrill 1991; Stollow 1966, 1979, 1987) and will only be summarized here.

Packing-case construction

Packing cases for panel paintings should be rigid to ensure that panels do not flex or twist during handling and transport. Rigidity can be accomplished by the use of relatively stiff materials and quality construction techniques. It is recommended that glue be used in the joinery of the cases because it increases the strength and stiffness of the joints. Case joints held together with only nails or screws perform poorly when dropped. "A case having edges and corners that are well-joined can have over ten times the strength and one hundred times the rigidity of a case that has corners and edges that are poorly joined" (Richard, Mecklenburg, and Merrill 1991).

Compared to single packing-case designs, double packing cases provide significantly better protection for panel paintings because an inner case adds rigidity to the structure. An inner case also increases the level of thermal insulation and reduces the likelihood of damage should the outer case be punctured by a sharp object, such as the blade of a forklift.

Figure 24 depicts a double packing-case design commonly used at the National Gallery of Art in Washington, D.C. The polyester urethane foam not only functions as a cushioning material but also provides thermal insulation. The entire case is lined with a minimum of 5 cm of foam, which proves adequate insulation for most transport situations if temperature-controlled vehicles are used. A packing case for a typical easel-sized painting has a thermal half-time of two to three hours (Fig. 25) (Richard 1991a). The foam thickness should be increased to at least 10 cm if extreme temperature variations are anticipated. However, thermal insulation only slows the rate of temperature change within the case: increasing the thickness of the insulation increases the thermal half-time to approximately four to five hours.

Figure 24

Interior view of the outer packing case of a double-case packing system.

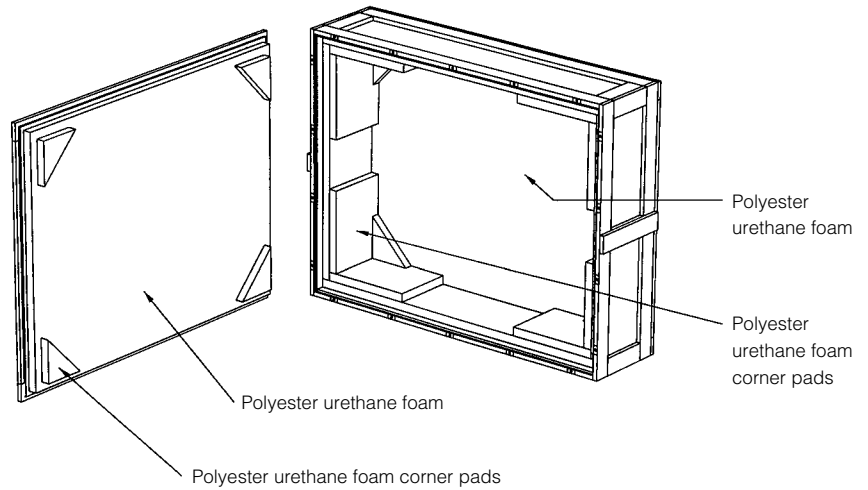
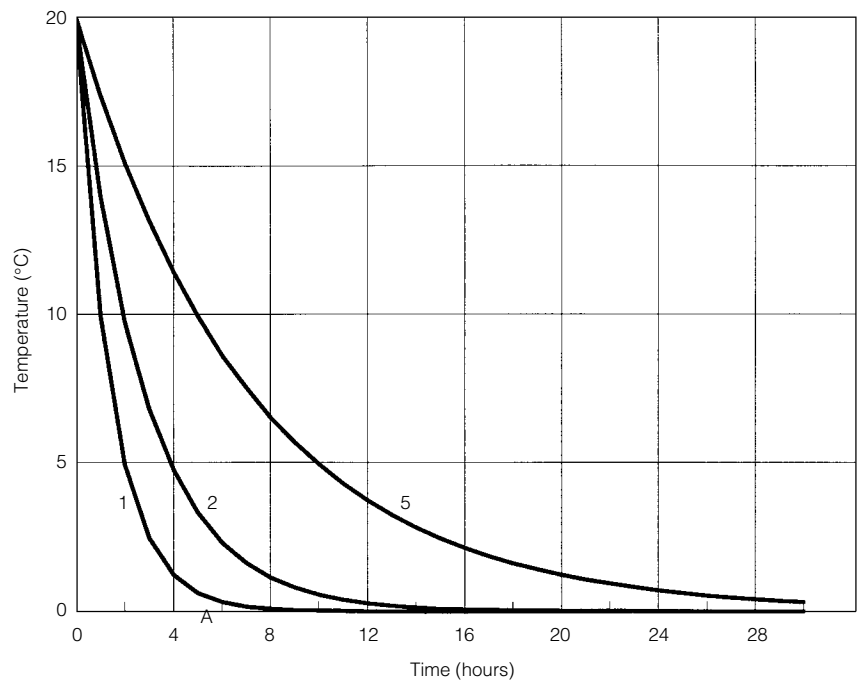

Figure 25

Thermal half-times for three different case designs. The cases were initially conditioned at 20 °C environment. The half-times shown are 1, 2, and 5 hours. Even for a well-insulated case (such as the 5-hour half-time example), little time is available before the case equilibrates to a new temperature.



When paintings are transported in extreme climates, the only way to maintain temperature levels that will not damage paintings is through the use of temperature-controlled vehicles.

Foam-cushion design

In the packing-case design depicted in Figure 24, the polyester urethane foam provides shock protection for the painting. The painting should be firmly secured within the inner case. There are two procedures that are commonly used: (1) the painting's frame is secured to the inner case with metal plates and screws, or (2) the frame is held in place with strips of foam. Shock protection in a double case design is provided by foam cushions fitted between the inner and outer cases. When a packing case is dropped, the foam cushions compress on impact, allowing the inner case

to move within the outer case. While the acceleration of the outer case is quickly halted on impact with the floor, the acceleration of the inner case is halted much more slowly. If the packing system functions properly, the outer case may sustain a few hundred Gs on impact, while fewer than 50 G are transmitted to the inner case and the painting inside.

It is easy to attain 50-G protection for panel paintings when packing cases are dropped less than 1 m. In fact, if careful attention is given to the proper use of foam cushioning materials, 25-G protection can be attained. The shock-absorbing properties of cushioning materials are provided in graphs known as *dynamic cushioning curves* (Fig. 26). These curves plot the G forces transmitted to a packed object as a function of the static load of the cushioning material. The curves vary with different materials, thicknesses, and drop heights. Dynamic cushioning curves for many materials are published in the *Military Standardization Handbook* (U.S. Department of Defense 1978). More accurate cushioning curves for specific products are usually available from the manufacturers. The use of these curves has been extensively discussed in several publications (Piechota and Hansen 1982; Richard 1991b).

Two cushioning curves for polyester urethane foam with a density of 33 kg m^{-3} are shown in Figure 26. Both are calculated for a drop height of 75 cm. Note that an increase in foam thickness dramatically effects the cushioning properties of the material. The lowest point on each curve corresponds to the optimal performance for a given thickness of the material. Therefore, as seen in Figure 26, the optimal static load for 10 cm thick polyester urethane foam is approximately 0.025 kg cm^{-2} (point A, Fig. 26). The static load is the weight of the object divided by the area in contact with the foam cushioning. At this static load, a painting packed with 10 cm thick cushions of polyester urethane foam will sustain a shock force

Figure 26
Dynamic cushioning curves for two thicknesses of polyester urethane foam. The curves show the distinct advantage of using the thicker material.

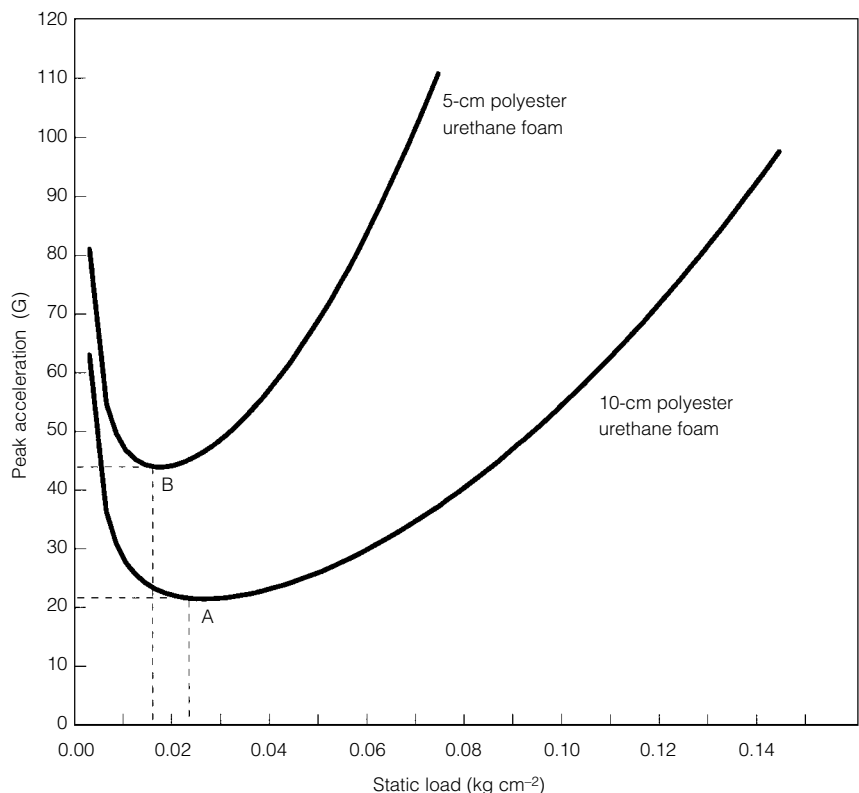

of approximately 22 G. If the cushioning in the packing case is 5 cm thick, then the optimal static load is 0.016 kg cm^{-2} and a force of 45 G would be anticipated (point B, Fig. 26). Because of the dramatic improvement in the performance of the 10 cm thick foam as compared to the 5 cm thick foam, it is highly recommended that foam cushions at least 10 cm thick be used in packing cases built for the transport of panel paintings.

It is not possible to predict the fragility of every panel painting accurately, although the methods described provide a good estimate for reasonably sound objects. Due to cracks and unseen defects, panel paintings will always be more—never less—fragile than calculated. Manufacturing companies that sell mass-produced items destructively test a few to ascertain their fragility. In this way, the company can design an adequately protective package at the least possible cost. While a small percentage of the items will be damaged, the expense incurred due to loss will be less than the cost of more complex and expensive packing cases. In the absence of accurate fragility information, it is recommended that packing cases provide at least 40-G protection for small panel paintings and 30-G protection for larger panel paintings. To provide optimal performance, the foam cushions should be at least 10 cm thick, and the static load on the foam should be calculated, using dynamic cushioning curves, to provide optimal performance.

Wrapping Materials for Paintings

Wrapping paintings in moisture-barrier materials is one way to control their moisture content during transport (Hackney 1987). Relatively thick polyethylene films that are well sealed with packaging tape usually work effectively. The quality of commercial polyethylene film materials varies considerably, however: the film is often made from recycled materials, and a low-quality film might result from the addition of grease, oil, chemical additives, and powders during the manufacturing process. Better moisture-barrier materials are available, but in ordinary transport situations, they provide few advantages over polyethylene sheeting, provided it is of high quality. It would be advantageous, however, to use the better materials when paintings are stored for many weeks in an environment having extremely high or low RH, or one having high concentrations of atmospheric pollutants.

Conservators and packers are often concerned that wrapping paintings in a moisture barrier causes condensation. Condensation problems can occur in packing cases containing large volumes of air relative to the mass and surface area of the hygroscopic materials inside. However, when a typical panel painting is wrapped in polyethylene, the volume of air is very small relative to the mass and surface area of the painting and frame. In this case, experimental evidence indicates that condensation will not occur unless a painting is acclimated to a very high RH level (at least 70%) and is exposed to a rapid and extreme temperature drop in a noninsulated packing case. The most likely cause of condensation is unpacking and unwrapping a cold painting in a warm room (those who wear eyeglasses have experienced similar condensation problems when they walk indoors on a cold winter day). This problem can be avoided simply by allowing several hours for the painting to acclimate to the higher temperature while it is still in the insulated case.

Wrapping paintings in polyethylene or an alternate moisture-barrier material is particularly important when there is uncertainty about

the environment in which the packing cases will be stored. Most packing cases contain hygroscopic materials, and if they are stored in environments having an unusually high or low RH, they acclimate to that environment. Unless sufficient time (usually a week or two) is allowed for the cases to reacclimate to the proper RH before packing, inappropriate microenvironments may be created in the cases. Similar problems can occur when packing cases are constructed from wood that has not been acclimated to the proper RH; a moisture-barrier film surrounding the painting reduces the potential of damage from an inappropriate environment.

To improve the microclimate inside packing cases, buffering materials such as silica gel can be added. Additional buffering materials slow the variation of moisture content in the painting, should it be subjected to extreme variations of RH for an extended period of time. The greatest risk in adding silica gel to a packing case is the possibility of using improperly conditioned silica gel. Even if the gel is carefully conditioned by the lending institution, it is always possible that it has become improperly conditioned during the period when the packing cases were in storage. Therefore, if silica gel is used, it is essential that it be checked for proper conditioning each time it is packed.

Silica gel can also be used in a microclimate display case in which the painting remains during exhibition. A properly constructed display case provides a stable microclimate environment for a panel painting and is particularly useful when a painting is accustomed to an environment that the borrowing institution cannot achieve. A panel acclimated to 65% RH, for example, could be placed in a microclimate display case while on loan to a borrowing institution that can only maintain 35% RH during winter. It must be kept in mind, however, that mold growth can develop inside microclimate display cases acclimated to a high RH.

Hand Carrying Panel Paintings

Because of concerns about their fragility, panel paintings are often hand carried by courier during transit. In certain situations, there are advantages to hand carrying works of art. The work remains in the possession of the courier at all times—a situation not possible if works are sent as cargo on an aircraft. The painting will be subjected to smaller temperature variations if the courier is conscientious about time spent in unusually cold or warm locations. However, there are some risks associated with hand carrying works of art. It is important that the painting fit into a lightweight but sturdy case that is easily carried and small enough to fit in a safe location on an aircraft, ideally under the seat. Overhead compartments should not be used because the work could accidentally fall to the floor should the compartment door open during the flight. The case might be placed in an aircraft coat closet if necessary, but it must be secured so that no movement can occur.

Another risk with hand carrying works of art is theft. Carried materials of high value are a potential target for well-informed thieves. Although this is an extremely rare problem, it is a concern that nevertheless must be considered. While couriers may feel more secure because they are never separated from their packing cases, this proximity doesn't necessarily mean that the work is actually safer.

There are many ways to pack a panel painting for hand carrying on an aircraft. Metal photographic equipment cases have proved very success-

ful. These cases come in various sizes and shapes, the smaller ones fitting conveniently under aircraft seats. The procedure for packing a painting in these cases is straightforward. The National Gallery of Art in Washington, D.C., often follows these steps: First, either the framed panel painting is wrapped directly in polyethylene and sealed with waterproof tape, or it is placed in an inner case that is wrapped in polyethylene. Unframed panels are always fitted into an inner case to prevent anything from touching the surface of the painting. The metal photography case is then filled with polyester urethane foam. A cavity is cut into the foam with a minimum of 2.54 cm of foam remaining on all sides. In this cavity, the wrapped painting or inner case is placed. In this procedure the polyester urethane foam functions as both cushioning material and thermal insulation.

Conclusion

Most panel paintings that are in good condition and free to respond dimensionally to environmental variations can be safely transported, as long as they are packed properly. However, there are circumstances when some paintings are at greater risk than others. Therefore, all panels should be carefully examined and an assessment should be made of RH- and temperature-related stresses that may develop from improper framing techniques or from restraint imposed by cradles or battens. Existing cracks in the design layers usually act as expansion joints, but cracks in panels can prove to be a potential problem, especially if the painting is subjected to impact.

It is also important to compare the RH levels where the painting normally hangs to the RH levels at the borrowing institution. If there is a large discrepancy in the RH, a microclimate display case could be used. Tables 2–4 summarize the relative RH-related risks for sample paintings of different construction and grain orientation. For example, Table 2 shows the risks of transporting a restrained, tangentially cut, white oak panel that has been equilibrated to 70% RH or higher.

Tables 3 and 4 show that it is potentially hazardous to ship a panel painting that has been equilibrated to 70% RH or higher and that has a gesso ground or paint directly applied to the wood—particularly if the wooden support is tangentially cut and not restrained.

To maintain stable moisture contents, paintings should be wrapped in moisture-barrier materials, provided they are not already conditioned to an unusually damp environment. Because condensation can occur when paintings acclimated to very high RH are transported in extremely cold weather, such transport could encourage mold growth.

Table 2 Maximum allowable RH ranges and relative risks for sound, uncracked, and restrained white oak panels in different grain orientations

Panel grain orientation	Equilibrium RH (%)	Allowable RH range to yield (%)	Relative risk
Tangential	36	25–54	medium
Tangential	50	33–63	low
Tangential	70	62–73	high
Radial	50	23–75	low
Radial	70	40–85	low

Table 3 Maximum allowable RH ranges and relative risks for well-attached gesso applied to unrestrained white oak panels in different grain orientations

Panel grain orientation	Equilibrium RH (%)	Allowable RH range to yield (%)	Relative risk
Longitudinal	50	20–86	low
Radial	50	22–79	low
Tangential	50	33–62	medium
Longitudinal	64	29–93	low
Radial	64	33–87	low
Tangential	64	53–68	high
Longitudinal	70	32–96	low
Radial	70	32–84	low
Tangential	70	65–73	very high
Longitudinal	36	12–75	low
Radial	36	15–71	low
Tangential	36	26–54	medium

Table 4 Maximum allowable RH ranges and relative risks for well-attached oil paint applied to unrestrained white oak panels in different grain orientations

Panel grain orientation	Equilibrium RH (%)	Allowable RH range to yield (%)	Relative risk
Longitudinal	50	8–95	low
Radial	50	13–86	low
Tangential	50	27–65	medium
Longitudinal	64	16–95	low
Radial	64	20–92	low
Tangential	64	43–71	medium
Longitudinal	70	17–95	low
Radial	70	19–90	low
Tangential	70	61–75	very high
Longitudinal	36	4–92	low
Radial	36	8–88	low
Tangential	36	22–60	medium

Table 5 Approximate glass-transition temperatures for selected paints

Material	Glass-transition temperature, T_g (°C)
Oil paint	–10
Alkyd paint	–5
Acrylic paint	+5

Temperature variations during transit should be minimized by use of climate-controlled vehicles and thermal insulation inside packing cases. Table 5 gives the typical glass-transition temperatures for three types of paint. However, paintings should never be subjected to temperatures as low as these values and, ideally, should stay above 10 °C.

Careful attention should be given to the selection and proper use of cushioning materials in the packing cases to ensure that paintings are not exposed to edge drops resulting in forces exceeding approximately 40–50 G.

For panel paintings, topple accidents can cause more severe damage than edge drops. The edges of panel paintings should be supported

Table 6 Topple-accident G levels required to break selected wooden panels cut in the tangential direction and supported along the two parallel-to-grain directions

Panel width (cm)	Panel thickness (cm)	Topple G at failure: White oak	Topple G at failure: Pine
127	1.25	29	19
127	1.90	44	28
127	2.53	59	37
102	1.25	46	29
102	1.90	69	44
102	2.53	92	58
76	1.90	82	52
76	1.90	122	77
76	2.53	163	103

continuously around the edges when in the frame and during transport. The panel must be free to move in response to changes in temperature and RH. See Table 6 for the approximate topple-accident G levels that will break uncracked panels of various dimensions and woods. This table assumes that there is no auxiliary support, such as battens or cradles attached to the panels, and that the wood is cut in the tangential direction. Woods cut in the radial direction are approximately 40% stronger than the examples provided in Table 6.

Low temperatures can severely reduce the effectiveness of foam cushions in reducing impact G levels.

Normally, transit vibration in panel paintings can be successfully attenuated by the foam cushions used to protect the painting from impact damage.

References

Hackney, S.
1987 The dimensional stability of paintings in transit. In *ICOM Committee for Conservation 8th Triennial Meeting, Sydney, Australia, 6–11 September 1987, Preprints*, 597–600. Marina del Rey, Calif.: Getty Conservation Institute.

Marcon, P.
1991 Shock, vibration, and the shipping environment. In *Art in Transit: Studies in the Transport of Paintings*, ed. M. F. Mecklenburg, 121–32. Washington, D.C.: National Gallery of Art.

Mecklenburg, M. F., ed.
1991 *Art in Transit: Studies in the Transport of Paintings*. Washington, D.C.: National Gallery of Art.

Mecklenburg, M. F., and C. S. Tumosa
1991 Mechanical behavior of paintings subjected to changes in temperature and relative humidity. In *Art in Transit: Studies in the Transport of Paintings*, ed. M. F. Mecklenburg, 173–216. Washington, D.C.: National Gallery of Art.

Mecklenburg, M. F., C. S. Tumosa, and D. Erhardt
1998 Structural response of painted wood surfaces to changes in ambient relative humidity. In *Painted Wood: History and Conservation*, ed. Valerie Dorge and F. Carey Howlett. Los Angeles: Getty Conservation Institute.

- Mecklenburg, M. F., C. S. Tumosa, and M. H. McCormick-Goodhart
 1995 A general model relating applied forces to environmentally induced stresses in materials. *Materials Issues in Art and Archaeology*, vol. 352, ed. P. B. Vandiver, J. R. Druzik, J. L. Galvan Madrid, I. C. Freestone, and G. S. Wheeler, 285–92. Pittsburgh: Materials Research Society.
- Ostrem, F. E., and W. D. Godshall
 1979 An assessment of the common carrier shipping environment. *USDA General Technical Report No. 22*. Madison, Wisc.: Forest Products Laboratory.
- Ostrem, F. E., and B. Libovicz
 1971 A survey of environmental conditions incident to the transportation of materials. *GARD Report No. 1512-1*. Niles, Ill.: General American Research Division.
- Piechota, D., and G. Hansen
 1982 The care of cultural property in transit: A case design for traveling exhibitions. *Technology and Conservation* 7(4):32–46.
- Richard, M.
 1991a Control of temperature and relative humidity in packing cases. In *Art in Transit: Studies in the Transport of Paintings*, ed. M. F. Mecklenburg, 279–97. Washington, D.C.: National Gallery of Art.
- 1991b Foam cushioning materials: Techniques for their proper use. In *Art in Transit: Studies in the Transport of Paintings*, ed. M. F. Mecklenburg, 269–78. Washington, D.C.: National Gallery of Art.
- Richard, M., M. F. Mecklenburg, and R. Merrill
 1991 *Art in Transit: Handbook for Packing and Transporting Paintings*, 1–4. Washington, D.C.: National Gallery of Art.
- Saunders, D.
 1991 Temperature and relative humidity conditions encountered in transportation. In *Art in Transit: Studies in the Transport of Paintings*, ed. M. F. Mecklenburg, 299–309. Washington, D.C.: National Gallery of Art.
- Stolow, N.
 1966 *Controlled Environments for Works of Art in Transit*. London: Butterworths.
- 1979 *Conservation Standards for Works of Art in Transit and on Exhibition*. Paris: Unesco.
- 1987 *Conservation and Exhibition: Packing, Transport, Storage, and Environmental Considerations*. London: Butterworths.
- U.S. Department of Agriculture
 1987 *Wood Handbook: Wood as an Engineering Material*. Agriculture handbook no. 72. Madison, Wisc.: U.S. Forest Products Laboratory.
- U.S. Department of Defense
 1978 *Military Standardization Handbook: Package Cushioning Design*. U.S. Department of Defense handbook no. MIL-HDBK-304B. Washington, D.C.: U.S. Department of Defense.
- Weaver, W., and J. M. Gere
 1965 *Matrix Analysis of Framed Structures*. 2d ed. New York: Van Nostrand.

Contributors

Odile Baÿ entered the paintings conservation department of the Louvre Museum to work on the Campana Collection in 1967; she was later appointed director of the department, which by then served all of the museums in France. She collaborated with the cabinetmaker René Perche until his retirement and then with his successor, Daniel Jaunard of the Atelier Claude Huot, until her retirement in 1989.

Ségolène Bergeon became a professor of physics in 1965 and a museum conservator in 1969. She joined the Service de Restauration des Peintures des Musées Nationaux in 1970, serving as director from 1981 to 1988. Her career has included work at the Villa Medici and the International Centre for the Study of the Preservation and the Restoration of Cultural Property, Rome (ICCROM), and she became the president of the ICCROM Council in 1993. She is the author of several publications and has curated several conservation exhibitions.

George Bisacca is a conservator at the Metropolitan Museum of Art in New York, where he has worked since 1983, and holds an adjunct professorship at the Institute of Fine Arts, New York University. He trained in paintings conservation at the Palazzo Pitti with Andrea Rothe and Alfio Del Serra and specialized in the treatment of panel paintings with Renzo Turchi and Giovanni Marrusich of the Opificio delle Pietre Dure.

Robert A. Blanchette, Ph.D., is a professor in the Department of Plant Pathology at the University of Minnesota at Minneapolis St. Paul. He has written numerous scientific articles and reviews on degradation processes of living trees and wood products and has coauthored two books dealing with microbial degradation of wood. His current research involves biodeterioration of archaeological wood from terrestrial and aquatic environments, as well as the development of conservation methods for decayed wood.

Simon Bobak, conservator of paintings, currently works in London. He is a fellow of the International Institute for Conservation. He also holds the position of honorary chief conservator at the Hamilton Kerr Institute, Cambridge, England.

David Bomford, who is now senior restorer of paintings at the National Gallery, London, joined that institution as a junior restorer in 1968, after postgraduate research in chemistry; he was trained by Helmut Ruhemann. At the National Gallery, Bomford has worked on a large number of paintings and has lectured and published widely, especially on the study of European painting techniques. He was coorganizer and coauthor of the award-winning series of exhibitions and catalogues called "Art in the Making," on the subjects of Rembrandt, fourteenth-century Italian painting, and Impressionism, and he also served for ten years as editor of the international journal *Studies in Conservation*. In addition, Bomford serves as secretary-general of the International Institute for Conservation. In 1996–97, he was the first conservator to become Slade Professor of Fine Art at Oxford University.

Jacqueline Bret is an engineer and a physicist at the Institut de Physique et de Chimie Industrielles de Lyon. She holds an advanced degree from the Ecole du Louvre and is a research specialist with the Service de Restauration des Musées de France, Petite Ecurie du Roy, Versailles.

Al Brewer, a Canadian who learned much from his father with regard to forests, wood, and woodcraft, received a B.Sc. in forestry from the University of New Brunswick, in eastern Canada (1983), attended the Pennsylvania Academy of the Fine Arts for two years (1978–80), and received a master's degree in art conservation from Queen's University in Canada in 1987. Since then he has conserved easel paintings, specializing in panel structural work, at the Hamilton Kerr Institute, University of Cambridge, where he has also taught. More recently, he has concentrated on researching the effects of overall reinforcement structures on the preservation of panel paintings.

Ciro Castelli began work as a joiner in 1957, progressing to the position of cabinetmaker for a private company. In 1966 he began restoring panel paintings and wooden structures at the Fortezza da Basso's state-run laboratory, including paintings damaged in the flood of 1966. Now with the Opificio delle Pietre Dure e Laboratori di Restauro, Florence, Italy—where he has also been a teacher since 1978—he has restored important works by Masaccio, Giovanni del Biondo, Raffaello Sanzio, and Botticelli, among many others. As a consultant and restoration expert representing the public museums of Italy, Castelli has served on official delegations at international art meetings. His reports have appeared often in *OPD Restauro*, as well as in restoration catalogues and conservation congress transcripts.

Vinod Daniel received his M.Tech degree in chemical engineering in 1986 from the Indian Institute of Technology in Madras, India, where he worked on the rheological characteristics of polymer blends. He received his M.S. degree in physical chemistry in 1991 from Texas Christian University, where his thesis addressed diffusion in liquids. From 1991 to 1994 he was a senior research fellow in the environmental sciences division at the Getty Conservation Institute. His research involves museum cases, moisture buffers in display cases, nontoxic fumigation, and data acquisition. He is presently scientific officer at the Australian Museum in Sydney, Australia.

Gilberte Emile-Mâle completed advanced studies in art history at the Sorbonne. In 1950 she became head of paintings restoration at the Louvre Museum and served as head conservator of the Service de Restauration des Peintures des Musées Nationaux from 1971 until her retirement in 1981. She is the author of numerous articles on the history of the restoration of paintings.

Jean-Albert Glatigny, an art restorer, specializes in the treatment of wood supports. After studying cabinetmaking, he took four years' training at the Institut Royal du Patrimoine Artistique (IRPA), Brussels, in the polychrome sculpture and panel painting workshops. In addition to his restorer's activities at IRPA and abroad, he teaches at several restoration schools and participates in studies of works of art and conducts research on ancient techniques of woodworking.

Gordon Hanlon received his B.A. degree in biology from the University of York, England, in 1979. From 1980 to 1984 he was assistant curator of Road Transport and Agricultural Implements at the Museum of Science and Technology, London. In 1984 he started a four-year studentship at the Victoria and Albert Museum, London, specializing in the conservation of furniture and gilded objects. In 1988 he joined the J. Paul Getty Museum as an intern and is now associate conservator in the Decorative Arts and Sculpture Conservation department. He specializes in the conservation of gilded furniture.

R. Bruce Hoadley holds a B.S. in forestry from the University of Connecticut, as well as master's and doctorate degrees in wood technology from Yale University. He is currently a professor in wood science and technology at the University of Massachusetts at Amherst, where his principal teaching and research interests are the anatomy and fundamental properties of wood. His wood identification analyses have been included in catalogues of major collections, including those of the Metropolitan Museum of Art in New York, the Garvan Collection at Yale University, the furniture collection at the J. Paul Getty Museum, and the diplomatic reception rooms at the U.S. Department of State. He is the author of two books, *Understanding Wood* (1980) and *Identifying Wood* (1990), and of more than fifty scientific and popular articles relating to wood.

James S. Horns studied with Richard Buck from 1971 to 1974 at the Intermuseum Conservation Association at Oberlin College, in Ohio, where he received a master of arts degree in conservation. He was a paintings conservator at the Minneapolis Institute of Arts from 1974 to 1978 and at the Upper Midwest Conservation Association from 1979 to 1986. Since that time he has been a conservator in private practice in Minneapolis.

Claude Huot carries on a two-generation tradition of cabinetmaking, having practiced under his father, Georges Huot, whom he succeeded as director of his studio in 1962, and René Perche. An avid personal interest in airplanes and gliders has allowed him to become better acquainted with various uses of wood and its mechanical behavior, from the standpoints of both piloting and conserving aircraft made of wood and canvas.

Daniel Jaunard is a cabinetmaker and restorer of support frames for easel painting. He has previously worked with René Perche at the Atelier Claude Huot and is licensed by the Service de Restauration des Musées de France.

Peter Klein graduated with a degree in wood technology from the University of Hamburg in 1973 and received a doctoral degree, with a specialty in wood science, from the same university in 1976. From 1976 to 1978 he served on the staff of the university's Department of Wood Biology, and from 1979 to 1981 he was a visiting scientist at the Gemäldegalerie Berlin-Dahlem. Since 1981 he has served on the staff of the University of Hamburg's Department of Wood Biology. His research activities concentrate on wood biology and technology, wood conservation and preservation, and dendrochronology.

Frédéric J. M. Lebas studied at the Institut Suisse pour l'Etude de l'Art in Zurich; he later served as paintings and sculpture restoration assistant to Th. Brachert at the Germanisches National Museum, Nuremberg, and held a one-year fellowship to the Institut Royal du Patrimoine Artistique de Bruxelles. Since 1979 he has served as restorer of paintings and sculpture at the Museum für Kunst und Gewerbe, Hamburg.

Patrick Mandron is a graduate of the Institut Français de Restauration des Oeuvres d'Art. A cabinetmaker and restorer of support frames for easel painting, he teaches at the Sorbonne, Université de Paris I, in the Maîtrise des Sciences et Techniques de la Conservation des Biens Culturels. He is licensed by the Service de Restauration des Musées de France.

Raymond Marchant has a background in design engineering, carpentry, cabinetmaking, and furniture restoration. He has also worked for John Bull in London as a technician restoring metal sculpture. In 1989 he joined Simon Bobak in association with the Hamilton Kerr Institute (HKI), Cambridge, England. At the London studio of the HKI, he works on the structural conservation of panel paintings, and at the HKI in Whittlesford, Cambridge, he advises on the structural conservation of panel paintings.

Giovanni Marussich, who was born in Croatia, embarked on his professional life as a woodworker in 1948, and he immigrated to Florence in 1956. From 1962 to 1983 he was a wood conservator for panel paintings at the Fortezza da Basso, part of the Opificio delle Pietre Dure e Laboratori di Restauro (formerly the Soprintendenza alle Gallerie) in Florence. Since then he has done conservation on panel paintings for various institutions and has taught a course on wood conservation at the Museo de Arte de Catalunya in Barcelona. He has also been a consultant to the J. Paul Getty Museum. He is presently involved in a restoration campaign for war-ravaged paintings in the former Yugoslavia.

Ian McClure studied English literature at Bristol University and art history at Edinburgh. He became head of paintings conservation at Glasgow Art Gallery and Museum in 1978. In 1982 he was named assistant to the director at the Hamilton Kerr Institute, where he became director in 1983. He has written on various specific conservation projects and techniques, as well as on the history of conservation.

Marion Mecklenburg holds B.S., M.S., and Ph.D. degrees in structural engineering from the University of Maryland. He has worked for twenty years as a paintings conservator in the United States. In 1987 he joined the Conservation Analytical Laboratory of the Smithsonian Institution, where he is a senior research scientist and where for several years he was the assistant director for conservation research. He has also been an adjunct professor in the Department of Conservation at the University of Delaware, an assistant professor and director of the Fracture Mechanics Laboratory at the University of Maryland, and coordinator of the graduate program for material science at the Johns Hopkins University. His research interests include the mechanics of materials and the effects of the environment on the mechanical properties of materials.

Anthony M. Reeve is senior restorer at the National Gallery, London, where he joined the conservation department in 1963 and trained under Arthur Lucas, Helmut Ruhemann, and Louis Howard. He carries out all forms of conservation, cleaning, restoring, and structural work on all the paintings he conserves. Since 1977 he has been in charge of all structural work, research, development, and application of improved methods of conservation. He represents the fourth generation of picture restorers in his family.

Mervin Richard studied paintings conservation at Intermuseum Laboratory in Oberlin, Ohio, and joined the staff of the laboratory upon graduation. He then held positions as a paintings conservator at the Philadelphia Museum of Art and at the Winterthur Museum. Since 1984 he has been the head of exhibition conservation at the National Gallery of Art in Washington, D.C., where he is also the deputy chief of conservation. His research over the years has focused on the dimensional behavior of panel paintings and on the packing of works of art for transit. Richard has served as cochairman of the International Council of Museums (ICOM) Working Group for the Care of Works of Art in Transit, and as cochairman of the ICOM Working Group for Preventive Conservation.

Andrea Rothe has been conservator of paintings at the J. Paul Getty Museum since 1981. Born of German parents in Bolzano, Italy, he grew up in France and Spain during World War II. After the war he immigrated to the United States with his parents and attended school in North Carolina, New York, Florida, and Connecticut. After having been accepted into New York University's history of art program, he left with his parents for a trip to Europe. There an introduction by George L. Stout enabled him to begin an internship at the Uffizi Gallery in Florence that changed the course of his career. He worked first with a gilder, Raffaello Bracci, and then with the restorers Augusto Vermehren, Gaetano Lo Vullo, Leonetto Tintori, and Alfio Del Serra. He subsequently did internships with Hermann Lohe at the Bavarian State Galleries in Munich and with Josef Hajsinek and Franz Sochor at the Kunsthistorisches Museum in Vienna. After this period of training, he started working on contract for the Italian state in Florence, Naples, Urbino, Arezzo, and Siena. During this time he also became an assistant to Oskar Kokoschka at his summer academy, called the School of Vision, in Salzburg.

Ulrich Schiessl received a Ph.D. in art history from Ludwig-Maximilians University in Munich in 1978, and an M.A. in the conservation and restoration of easel paintings and polychrome sculpture from the Academy of Fine Arts in Stuttgart in 1981. Since 1983 he has been a professor in the conservation department at the Academy of Fine Arts in Dresden. He is a member of ICOM and an honorary member of the Swiss Association for Conservation and Restoration.

Arno P. Schniewind received B.S., M.W.T., and Ph.D. degrees in wood technology from the University of Michigan, Ann Arbor. He joined the Forest Products Laboratory, University of California, Berkeley, in 1956. Initially his specialty was the mechanical behavior of wood and wood-based materials, and he taught undergraduate and graduate courses and did research in this area. In 1982 he became interested in the application of wood science to the conservation of wooden artifacts, and he has since published a number of research papers on that topic. Since his early retirement in 1991, he has been professor emeritus and continues to be active.

Charles S. Tumosa has a Ph.D. in chemistry from Virginia Polytechnic Institute and State University. He has twenty-three years of experience running analytical laboratories and has spent his career examining and determining the character of materials. At present he is a senior research chemist at the Smithsonian Institution, where he works on the chemical and mechanical properties of cultural objects.

Luca Uzielli is a professor of wood technology and forest operations at the University of Florence, Florence, Italy. He specializes in the evaluation, restoration, and conservation of wooden artifacts, including supports of panel paintings, sculptures, and load-bearing timber structures of artistic and historical significance.

Zahira Véliz trained as a conservator of paintings at the Intermuseum Conservation Laboratory, receiving an M.A. from Oberlin College in 1978. She began working as a freelance conservator in Spain, collaborating extensively with the World Monuments Fund and the Royal Foundation of Toledo, and working in the conservation department of the Prado Museum in Madrid. She has taught at the Courtauld Institute, London, and at University College, London. Since 1990 she has been working privately in London and Spain, lecturing and writing on technical aspects of sixteenth- and seventeenth-century Spanish painting.

Jørgen Wadum received a bachelor's degree in art history from the University of Copenhagen in 1980. He graduated with his B.Sc. (1982) and M.Sc. (1987) in conservation from the School of Conservation, Copenhagen. He has worked as a freelance paintings conservator since 1983 and worked at Rosenborg Palace, Copenhagen, in 1987–88. In 1989 he was employed as a lecturer at the School of Conservation and at the University of Copenhagen. From 1990 to the present, he has been chief conservator of paintings at the Royal Picture Gallery Mauritshuis, The Hague. He is also the coordinator of the International Council of Museums Committee for Conservation Working Group on Scientific Study of Paintings: Methods and Techniques.

Philip Walker is a practical worker in wood with a special interest in the historical and contemporary use of tools and techniques of various trades and cultures. He has written and lectured widely on these subjects. In 1987 he was elected a fellow of the Society of Antiquaries of London. He is president of the Tool and Trades History Society, founded in 1983, which has members in eighteen countries worldwide.

Donald C. Williams has been a furniture restorer and conservator since 1972; his particular interests are in coating and adhesive materials. He received a B.A. in the technology of artistic and historic objects from the University of Delaware and joined the Conservation Analytical Laboratory (CAL) of the Smithsonian Institution in 1984 as furniture conservator. He later became senior furniture conservator. He is currently coordinator of education and training programs at CAL.

Antoine M. Wilmering received his training in furniture conservation under the aegis of the State Training Programme for Conservators in the Netherlands. He was awarded internships in the Historical Museum of Amsterdam and the Victoria and Albert Museum in London and received his certificate in Furniture Conservation from the Ministry of Culture in 1983. He was furniture conservator at Rijksmuseum Paleis Het Loo in the Netherlands before being hired in 1987 by the Department of Objects Conservation at the Metropolitan Museum of Art, New York, to direct the conservation treatment of the Gubbio studiolo. He is conservator at the Metropolitan Museum of Art and is responsible for overseeing the work of the furniture conservation staff in the Sherman Fairchild Center for Objects Conservation.

Illustration Credits

Front and back covers: Courtesy of The J. Paul Getty Museum, Los Angeles; photos by Louis Meluso.

Part One

Opening page: Courtesy of R. Bruce Hoadley.

Hoadley *Chemical and Physical Properties of Wood*
Figures 1–13: Courtesy of the author.

Hoadley *Identification of Wood in Painting Panels*
Figures 1–29: Courtesy of the author.

Klein *Dendrochronological Analyses of Panel Paintings*
Figures 1–15: Courtesy of the author.

Blanchette *Guide to Wood Deterioration*
Figures 1–8: Courtesy of the author.

Hanlon and Daniel *Modified Atmosphere Treatments*
Figures 1–8: Courtesy of the authors.

Schniewind *Consolidation of Wooden Panels*
Figures 1, 2: Courtesy of the author.

Part Two

Opening page: J. A. Roubo, *L'art du menuisier* (Paris: Académie Royale des Sciences, 1769).

Uzielli *Historical Overview*
Figures 1, 2, 6, 9, 13–15, 17–19, 21, 23, 27: Courtesy of Opificio delle Pietre Dure, Florence.
Figures 3, 4, 10–11, 20, 22, 24, 25, 28: Courtesy of the author; drawings by Camilla Burresti and Daniele Biffino. Figure 5: Courtesy of the author. Figures 7, 8, 12, 16: Courtesy of the Uffizi Gallery, Florence. Figure 26: Courtesy of the author; drawing by Camilla Burresti and Daniele Biffino, after drawing in Bomford et al. 1989.

Véliz *Wooden Panels and Their Preparation for Painting in Spain*
Figures 1–4, 7–8: Courtesy of the author. Figures 5, 6: Courtesy of Derek Johns Ltd., London.

Wadum *Historical Overview of Panel-Making Techniques*
Figure 1: Courtesy of the Academy of Fine Arts, Warsaw. Figures 2, 3, 15, 16, 19a–b: Courtesy of The Royal Danish Collections, Copenhagen. Figure 4: Courtesy of Sotheby's. Figures 5a–d, 6, 7a–h, 14a–d: Courtesy of the author. Figures 8, 20: Courtesy of Statens Museum for Kunst, Copenhagen, Department of Conservation. Figures 9, 10, 17, 23, 25: Courtesy of The Royal Picture Gallery, The Mauritshuis, Conservation Department, The Hague. Figure 11: Courtesy of the *Nederlands Kunsthistorisch Jaarboek* 1978. Figure 12a–b: Courtesy of The National Gallery,

London. Figure 13: Courtesy of the Musée des Beaux-Arts de Rennes. Figure 18: Courtesy of the Musée des Beaux-Arts de Dijon. Figure 21: Courtesy of Christie's London. Figure 22: Courtesy of Christie's Amsterdam B.V. Figure 24: Courtesy of Instituut Collectie Nederland, Netherlands Institute for Cultural Heritage.

Walker *History of Relevant Woodworking Tools and Techniques*

Figure 1: Courtesy of the Bibliothèque Municipale de Dijon. Figure 2: Courtesy of the Cathédrale Notre Dame de Chartres. Figure 3: With permission of The Casa Editrice Francescana, Assisi. Figures 4–6, 10, 12a–c: Courtesy of the author. Figure 7a–b: Courtesy of the Early American Industries Association. Figure 15: Courtesy of Dr. G. Heine and the Tool and Trades History Society.

Part Three

Opening page: Courtesy of The J. Paul Getty Museum, Los Angeles; photo by Louis Meluso.

Rothe *Critical History*

Figures 1, 2, 5, 7, 8: Courtesy of the Ministero per i Beni Culturali e Ambientali, Soprintendenza per i Beni Ambientali Architettonici, Artistici e Storici di Arezzo. Figures 3, 11: Courtesy of the Ministero per i Beni Culturali e Ambientali, Soprintendenza per i Beni Artistici e Storici delle Marche, Urbino. Figure 4: Courtesy of the National Gallery, London. Figure 6: Courtesy of the Ministero per i Beni Culturali e Ambientali, Soprintendenza per i Beni Artistici e Storici di Bologna. Figures 9, 10: Courtesy of The J. Paul Getty Museum, Los Angeles, California. Figure 12: Courtesy of the author. Figures 13–20: Courtesy of the Ministero per i Beni Culturali e Ambientali, Istituto Centrale per il Restauro, Rome. Figures 21, 22: Courtesy of the Sarah Campbell Blaffer Foundation, Houston, Texas.

Schiessl *History of Structural Panel Painting Conservation*

Figures 1–3: Photos by W. Rabich; courtesy of the Landesamt für Denkmalpflege Sachsen, Dresden. Figures 4, 17, 18: Courtesy of the Landesamt für Denkmalpflege Sachsen, Dresden. Figures 5, 19: Courtesy of the Schweizerisches Institut für Kunstwissenschaft, Zurich. Figures 6, 7, 12: Courtesy of the Bayerisches Nationalmuseum, Munich. Figures 8, 9: Courtesy of the Kunstmuseum Berne. Figure 10: Courtesy of the Hochschule für Bildende Künste, Dresden. Figures 11, 13–16, 20, 21: Courtesy of the Staatliche Kunsthalle Karlsruhe.

McClure *History of Structural Conservation of Panel Paintings in Great Britain*

Figures 1–3, 6–11: Courtesy of the Hamilton Kerr Institute. Figures 4, 5: Courtesy of Kingston Lacy, The Bankes Collection (The National Trust). Figures 12–15: Courtesy of Royal Collection Enterprises.

Bret, Jaunard, and Mandron *Conservation-Restoration of Wooden Painting Supports*

Figure 1: Photo Routhier; courtesy of the Service de Restauration des Musées de France. Figure 2: Photo by J. Requilé and D. Jaunard; courtesy of the Service de Restauration des Musées de France. Figures 3, 4: Photos by D. Jaunard; courtesy of the Service de Restauration des Musées de France. Figures 5, 6: Photos by G. Dufresne; courtesy of the Service de Restauration des Musées de France. Figures 7, 8: Photos by J. Requilé; courtesy of the Service de Restauration des Musées de France.

Bergeon et al. *Two Hundred Years of History In France*

Figures 1, 2, 12–14, 16: Courtesy of the Louvre Museum. Figures 3–11, 15, 17: Courtesy of the Musée du Petit-Palais, Avignon.

Horns *Richard Buck*

Figures 1–14: Courtesy of the Straus Center for Conservation, Harvard University Art Museums.

Part Four

Opening page: Courtesy of The J. Paul Getty Museum, Los Angeles; photo by Louis Meluso.

Rothe and Marussich *Florentine Structural Stabilization Techniques*

Figure 1: Courtesy of the Ministero per i Beni Culturali e Ambientali, Soprintendenza per i Beni Ambientali Architettonici Artistici e Storici di Arezzo. Figures 2, 5–8: Courtesy of the authors. Figures 3, 4, 10–12: Courtesy of The J. Paul Getty Museum, Los Angeles. Figure 9: Courtesy of the Staatliche Museen zu Berlin, Preussischer Kulturbesitz, Gemäldegalerie.

Castelli *Restoration of Panel Painting Supports*

Figures 1–28: Courtesy of the Ministero per i Beni Culturali e Ambientali, Opificio delle Pietre Dure di Firenze, Florence.

Bisacca *A Nativity by Francesco di Giorgio Martini*

Figures 1, 4, 5, 15, 25–33: © The Metropolitan Museum of Art, New York. Figures 2, 3, 7–13, 16–24: © 1997 Board of Trustees, National Gallery of Art, Washington, D.C. Figures 6a–c, 14b: © The Metropolitan Museum of Art. Drawings by Daniel Kershaw. Figure 14a: Courtesy of the Ministero per i Beni Culturali e Ambientali, Soprintendenza per i Beni Artistici e Storici di Siena.

Lebas *Cradling of a Relief Attributed to Martin Schaffner*

Figures 1–5: Courtesy of the Museum für Kunst und Gewerbe, Hamburg.

Glatigny *Backings of Painted Panels*

Figures 1, 6: Courtesy of the Musée Atohis, Ath, Belgium. Figures 2–5: Courtesy of the author.

Bobak *Flexible Unattached Auxiliary Support*

Figures 1–14: Courtesy of the author.

Marchant *Development of a Flexible Attached Auxiliary Support*

Figures 1–4, 6: Courtesy of the author. Figures 5, 7–18: Keirincx–Savery–Old Franks, *Orpheus Attacked by the Thracian Women* [*Death of Orpheus*], from a private collection.

Reeve *Structural Conservation of Panel Paintings at the National Gallery, London*

Figures 1–13: Courtesy of the Trustees of the National Gallery, London.

Brewer *Some Rejoining Methods*

Figures 1–3, 5–9: Courtesy of the author. Figure 4a–b: Private collection, Scotland.

McClure *Framing of Wooden Panels*

Figures 1, 3, 6–8, 10–16: Courtesy of the Hamilton Kerr Institute, Fitzwilliam Museum, University of Cambridge. Figures 4, 5, 9: Courtesy of Kingston Lacy, The Bankes Collection (The National Trust). Figure 2: The Chapel of Our Lady and St. Margaret, Oxburgh Hall (The National Trust).

Brewer *Practical Aspects*

Figure 1, 4c, 13: Courtesy of the author. Figures 2, 3, 7: Courtesy of the Hamilton Kerr Institute, Cambridge. Figures 4a–b, 14, 16a–b, 17: The Property of the Marquess of Northampton. Figure 5a–b: Courtesy of the Tate Gallery, London. Figure 6a–c: By kind permission of the Provost and Scholars of King's College, Cambridge. Figure 8a–e: Reproduction by permission of the Syndics of the Fitzwilliam Museum, Cambridge. (Figures 8b, 8d, 8e, photographs by Christopher Hurst.) Figures 9a–c, 10a–b, 11a–b, 12: Courtesy of the Warden and Fellows of All Souls College, Oxford. Figure 13: Courtesy of the J. Paul Getty Museum, Los Angeles. Figure 15: Courtesy of the Wallraf-Richartz Museum, Cologne.

Wilmering *A Renaissance Studiolo from the Ducal Palace in Gubbio*

Figures 1–3, 5–19: © The Metropolitan Museum of Art, Rogers Fund, 1939 (39.153). Figure 4: © The Metropolitan Museum of Art. Drawing by Daniel Kershaw.

Wadum *Microclimate Boxes for Panel Paintings*

Figures 1–3: Courtesy of the author.

Richard, Mecklenburg, and Tumosa *Technical Considerations for the Transport of Panel Paintings*

Figures 1–26: Courtesy of the authors.

The Getty Conservation Institute
Los Angeles

ISBN 0-89236-384-3

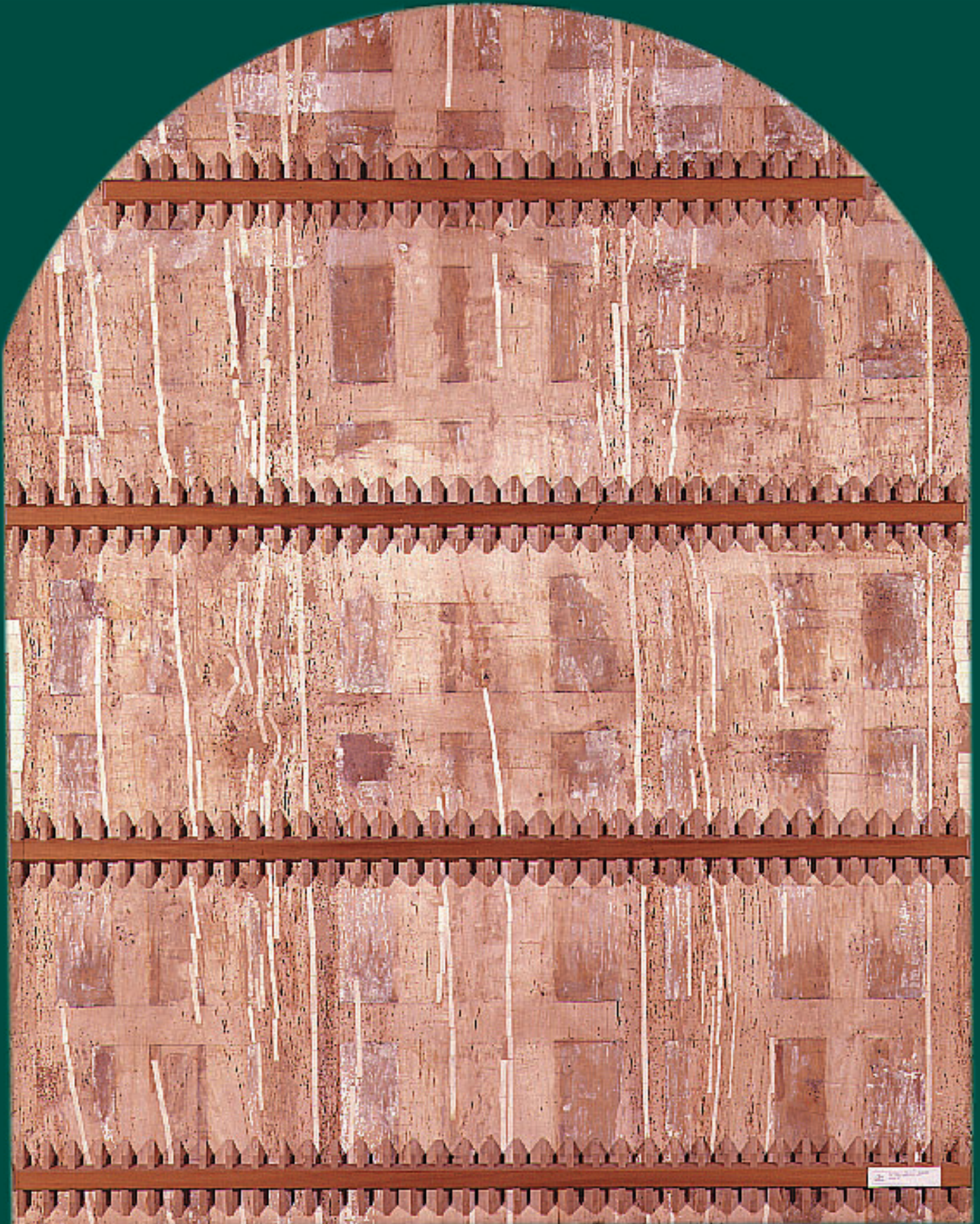

© 2000 The Getty Conservation Institute
Los Angeles, California